

**Concentrating Solar Power Commercial
Application Study:
Reducing Water Consumption of
Concentrating Solar Power Electricity Generation**

Report to Congress

U.S. Department of Energy

This report is being disseminated by the Department of Energy. As such, the document was prepared in compliance with Section 515 of the Treasury and General Government Appropriations Act for Fiscal Year 2001 (Public Law 106-554) and information quality guidelines issued by the Department of Energy. Though this report does not constitute “influential” information, as that term is defined in DOE’s information quality guidelines or the Office of Management and Budget’s Information Quality Bulletin for Peer Review (Bulletin), the study was reviewed internally prior to publication.

Table of Contents

Executive Summary.....	3
Introduction.....	6
Concentrating Solar Power Technologies.....	7
Parabolic Troughs.....	8
Linear Fresnel	9
Power Towers.....	9
Dish/Engine Systems.....	10
Comparison or Water Usage for Different CSP Cooling Options.....	11
Once-through Water Cooling.....	12
Evaporative Water Cooling.....	12
Dry Cooling.....	12
Hybrid Wet/Dry Cooling.....	14
Parallel Cooling System.....	15
Alternate and Future Technologies.....	18
Summary.....	18
References.....	19

Executive Summary

This report has been prepared in response to section 603(b) of the Energy Independence and Security Act of 2007, (Pub. L. No. 110-140), which states that “...*the Secretary of Energy shall transmit to Congress a report on the results of a study on methods to reduce the amount of water consumed by concentrating solar power systems.*”

Because of the huge solar resource available in the Southwest United States, utilities are showing increasing interest in the deployment of concentrating solar power (CSP) plants to meet the requirements of state renewable portfolio standards. The Federal government is also encouraging the development of CSP plants through a 30% investment tax credit.

This report discusses potential methods to reduce water consumption associated with CSP. Four main concentrating solar power technologies are described in this report: parabolic troughs, linear Fresnel, power towers, and dish/engine. Parabolic troughs are the most commercially available technology. Linear Fresnel and power tower technologies are presently being planned as commercial plants, but none have yet been built in the U.S. The first three of these technologies use the heat collected from the sun to power conventional Rankine steam cycles, similar to those used for coal and nuclear plants. Steam cycle power plants require cooling to function (cooling is needed to condense the steam and complete the cycle). This cooling can be provided via water cooling, air cooling or a combination. Dish/engine systems use sunlight to power a small engine at the focal point. Stirling cycle engines using hydrogen as the working fluid are typically employed in dish/engine systems. These are air-cooled and only require water for mirror washing.

Water cooling for thermoelectric power plants is accomplished using two methods: once-through cooling and recirculating evaporative cooling. Once-through cooling withdraws large volumes (23,000 to 27,000 gal/MWh) from a body of water and returns it to that source at an elevated temperature, which causes additional evaporative loss from that body of water. Recirculating evaporative cooling withdraws a lesser amount (500 to 650 gal/MWh for an equivalent plant) but consumes most of the water directly through evaporation.¹ It should be noted that once-through cooling may be restricted in use for new thermoelectric power plants based on concerns with the potential aquatic environmental impact of such systems.²

Air cooling rejects the heat of the steam cycle directly to the air. A fossil power plant using this technology withdraws water only for the steam cycle blowdown and domestic water uses, which amount to less than 10% of the consumption of an evaporative cooled plant.³



Figure 1: Above, power tower pilot project, pioneered in the U.S. (Barstow, CA) and (left) commercial unit under development by Abengoa called PS10, an 11 MW plant in Sevilla Spain (photo credit: Abengoa Solar). Bottom left, Stirling Dish/Engine, Center SEGS trough plants, Right, Compact Linear Fresnel Reflector.

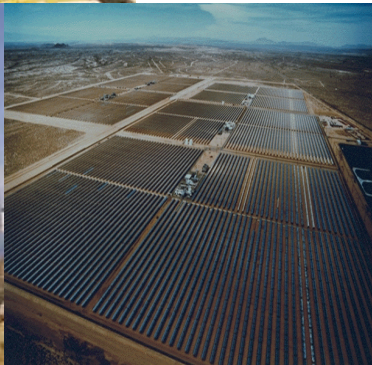

As with fossil and nuclear power plants, water cooling is generally more economical than air cooling for CSP plants because water cooling has a lower capital cost and higher thermal efficiency, and it maintains consistent efficiency levels year-round. In contrast, air cooling has reduced effectiveness when the air temperature is high. In the current commercial CSP plants, water is required to condense steam, provide make-up water for the steam cycle, and for mirror washing. The regions where CSP is most effective are those that have many hours of direct sunlight; these places often have relatively little water. Supplying water from more distant sources or purifying low quality water for CSP systems that use conventional water cooling can then increase costs. This report discusses various options by which CSP systems can operate efficiently with significantly less water consumption than they consume today.

The majority of new fossil power plants use evaporative water cooling to reject the steam cycle heat. A typical coal plant or nuclear plant consumes 500 gallons of water per MWh (gal/MWh) of electricity generated.^{1, 3} This is similar to the water consumption by a power tower. A combined-cycle natural gas plant consumes about 200 gal/MWh.⁴ A water-cooled parabolic trough plant consumes about 800 gal/MWh. Of this, 2% is used for mirror washing.⁵ Dish/engine systems only require water for mirror washing (approximately 20 gal/MWh).

To address water limitations and environmental regulations, air cooling can be used for new thermoelectric power plants, which eliminates over 90% of the water usage.⁶ The typical dry-cooled plant routes turbine exhaust steam directly to finned tubes on air-cooled condensers. A study of a dry-cooled parabolic trough plant located in the Mojave Desert concluded that dry cooling would provide 5% less electric energy on an annual basis and increase the cost of the produced electricity by 7 to 9%.⁷ However, the results are location-specific. For example, air cooling at a site in New Mexico would increase the cost of electricity by only 2% because maximum daytime temperatures are considerably lower there than in the Mojave Desert.⁸

The performance penalty of using air cooling also varies by technology. One study projected the annual electric output of a trough plant to drop by 4.6%, whereas that of a power tower to drop by only 1.3%. A simple model analysis estimates the differences between trough and tower technology using dry cooling will only differ by 0.5%.⁹ The economic consequences will vary with climate which impacts the cooling system performance, water conditions which affects the cost of water treatment for an evaporative cooling tower, and depend on the premium value of delivered electricity during peak demand consequent with high ambient temperatures. One study showed that the net present value of an air-cooled CSP plant can be improved by using a larger collector field which offsets the lower steam cycle efficiency resulting in higher power output during peak summer hours.¹⁰

Hybrid wet/dry cooling systems use some combination of wet and dry cooling to reduce water consumption. Several recent plants built to conserve water have used a parallel cooling system (PCS), which uses both an air cooler (typically smaller than that use for air-cooled-only plant) and a small wet cooling tower operating in parallel for use during the summer.¹¹ In hot weather, the steam exiting the turbine is split with one portion routed to the air-cooled condenser and the other stream routed to the water cooled condenser with heat rejection to an evaporative cooling tower. A model study for a parabolic trough CSP power plant, showed this reduces water consumption 50% with only a 1% drop in annual electrical energy output, or 85% with only a 3% drop in output. For the latter case, the levelized electricity cost would increase about 5% compared to a water-cooled plant, or somewhat less than the cost penalty estimated for a direct dry cooling plant.¹²

Air cooling and wet/dry hybrid cooling systems offer highly viable alternatives that could reduce the total water usage of steam-generating CSP plants by 80 to 90% at a penalty in electricity cost in the neighborhood of 2 to 10%, depending on plant location and other assumptions.¹³ The penalty for linear Fresnel designs has not yet been analyzed, but is expected to be somewhat higher than for troughs because of its lower operating temperature. Conversely, power towers would have a lower cost penalty because of their higher operating temperature. Additional research and development (R&D) and field experience should further decrease the need for water and help achieve cost penalties closer to the lower ends of these ranges.

Introduction

This report has been prepared in response to the Energy Independence and Security Act of 2007 (Pub. L. No. 110-140), section 603(b), which states:

“(b) Water Consumption- Not later than 6 months after the date of the enactment of this Act, the Secretary of Energy shall transmit to Congress a report on the results of a study on methods to reduce the amount of water consumed by concentrating solar power systems.”

Water consumption is an issue with concentrating solar power plants because they are most cost effective in locations where the sun is most intense, which in turn often corresponds to places like the Mojave Desert where there is little water. As shown in Figure 2, the Southwestern United States has excellent solar resources and is coincident with high demand centers. Solar energy is the largest available renewable energy resource in the Southwest region; it is so widespread that Concentrating Solar Power (CSP) projects covering 1.4% of southwestern land could potentially generate as much power as used in the entire U.S.¹⁴ California, for example, has excellent solar resources in the southern part of the state. The issue of the availability of water in this rapidly growing area, however, has caused California to place restrictions on power plant water use.¹⁵ Other Southwestern states may also eventually impose restrictions on the amount of water available for use by power plants.

This report attempts to identify concerns regarding water consumption for CSP, presents information on the water requirements of electrical power generation, and discusses technologies that address water use in the context of CSP power generation.

Peak power demand, particularly in California, Nevada and Arizona, is approaching system capacity and growing rapidly. It is expected that renewable energy sources will increasingly be tapped to meet market and regulatory demands. Many of the Southwestern states have established renewable portfolio standards (RPS) that encourage the development of technologies like CSP. RPS requirements now exist in 26 states and the District of Columbia, as shown in Figure 3.

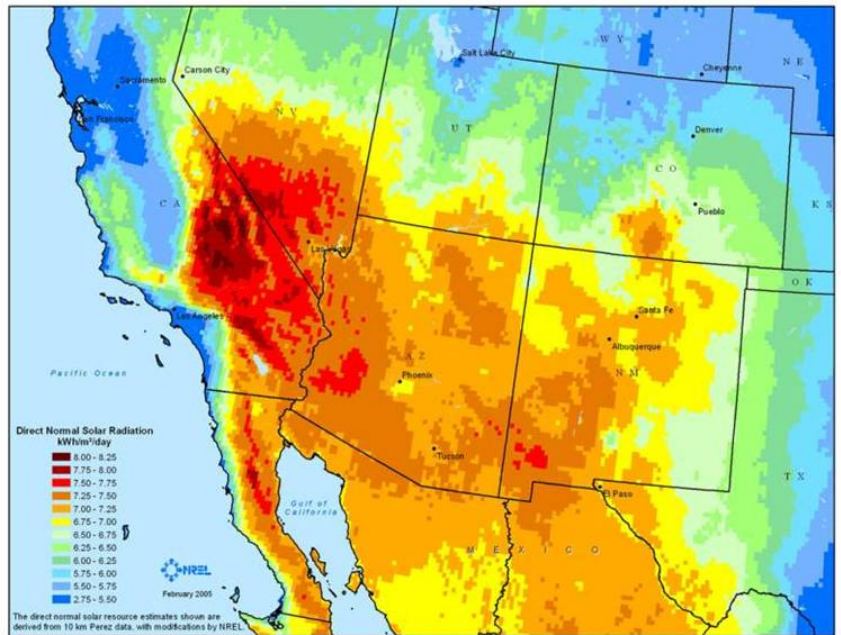

Figure 2: Solar Intensity in the Southwest

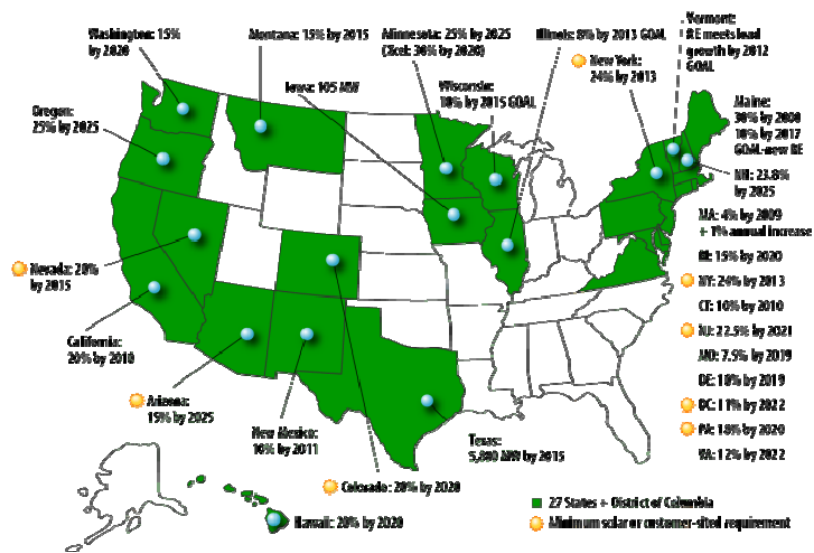

Figure 3: State Renewable Portfolio Standard requirements (Union of Concerned Scientists)

CSP power plants employing parabolic trough technology have been performing reliably on a commercial scale in the Southwestern United States for more than 15 years.¹⁶ Currently there are over 400 MW of generating capacity installed that are producing electricity on a utility scale, and there are power purchase agreements signed to construct an additional 4,000 MW over the next decade. Some of the benefits of CSP technology is that it can provide power during peak demand periods. Problems of solar intermittency can be overcome with thermal storage or hybridization with natural gas, allowing plants to dispatch power to the grid into the evening hours.

All of the existing commercial CSP power plants in the U.S. are parabolic trough systems that use a Rankine steam cycle to convert their thermal energy to electricity. This part of the solar plant, referred to as the power block, is similar to that used by coal, natural gas, and nuclear power plants. These power plants achieve the highest efficiencies when they are water-cooled. All operating CSP plants in the U.S. employ evaporative water cooling. The use of water for power plants is becoming constrained.¹⁷ For the CSP industry, there is a strong incentive to investigate alternative cooling approaches that minimize the use of water. The most promising of those approaches will be discussed later in this report.

Concentrating Solar Power Technologies

There are four primary CSP plant designs – solar trough, linear Fresnel, power tower, and dish/engine. All designs use a small amount of water for mirror washing.¹⁸ The first three of these technologies operate a steam cycle and require some water for steam makeup and, when they are water-cooled, require a substantial amount of water for heat rejection in a similar way as do water-cooled fossil and nuclear plants.¹⁹ The Rankine steam cycle is typical of what is employed in a fossil fueled power plant. Utility managers are thus familiar with the power-generating portion of these plants. Thermal

storage can be integrated with these three systems, to enhance dispatchability, allowing the solar plant to produce electricity into the night to meet peak demand periods.

Parabolic Troughs

Parabolic trough systems concentrate solar radiation, specifically direct normal insolation (DNI), onto a receiver tube located along the focal line of a single-axis tracking parabolically curved, trough-like reflector. Heat transfer fluid flowing through the receiver tube absorbs the thermal energy. The heat is collected and used to generate steam which is produced by a Rankine cycle turbine-generator. Trough systems can be hybridized (natural gas can be burned to produce steam when the sun isn't shining) or can use thermal storage to dispatch power to meet utility peak load requirements (Figure 4).

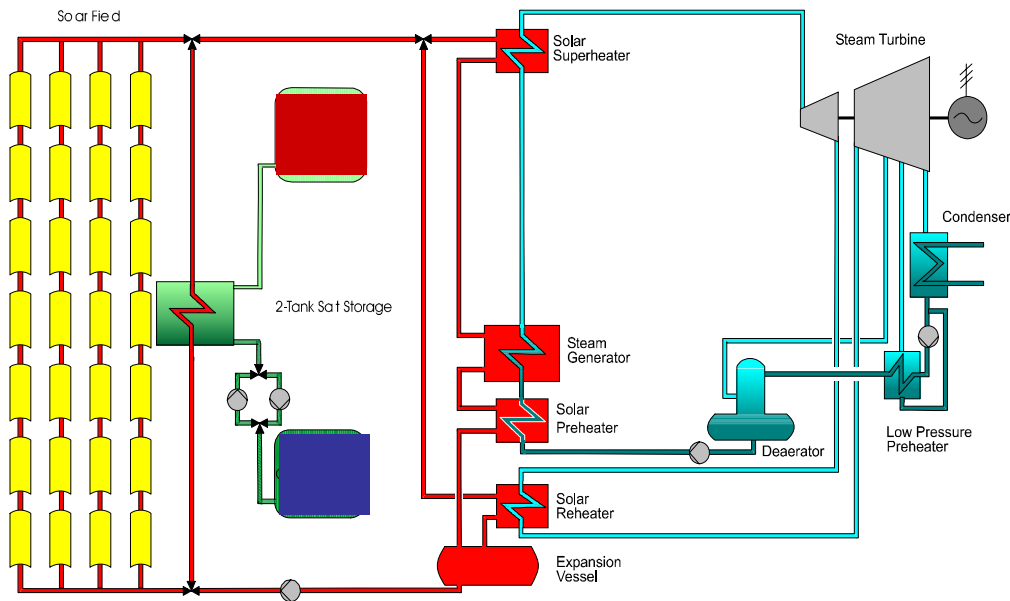

Figure 4: Parabolic trough system schematic

The operating temperature of trough plants is limited by the thermal property of the heat transfer fluid (HTF) that is suitable for pumping through miles of piping in the solar field. In typical applications, oil flowing through the receiver tube is heated to about 390°C and used to boil water to produce steam. The resulting steam is used in a Rankine power cycle and expanded through a turbine connected to an electric generator. As with any steam cycle, the exhaust steam is cooled and condensed back to liquid water to be recirculated in the cycle. The condensers can be either water-cooled or air-cooled, or a hybrid combination. Parabolic trough systems are the most developed and commercially tested technology and have operated at a capacity of 350 MW in the Mojave Desert for over 15 years. A new 64 MW trough plant was recently built near Las Vegas (Figures 5 and 6). A number of large trough projects are being planned in the Southwestern U.S.



Figure 5: 64 MW Nevada Solar 1 Solar Plant



Figure 6, Nevada Solar 1 solar collector

Linear Fresnel

This technology (see Figure 7) is a line-focus technology similar to troughs in that it consists of reflectors that track the sun in one axis and focus the beam radiation onto fluid-carrying receiver tubes. The difference is that it uses a series of ground-mounted mirrors, and the receiver tube is elevated above the mirrors and fixed. The optical efficiency is lower than that of troughs, but this technology offers the promise of cost savings and reduced land use, associated with the tight spacing and ground location of the mirrors and a fixed receiver. A current design being marketed employs water directly in the receiver tubes where it is boiled at about 50 bars of pressure (50 times atmospheric pressure) to produce saturated steam at 535°F, which powers a steam cycle. Another proposes to use molten salt in the receiver tube. As of yet, there are no commercially operating power-generating systems employing this technology, but some are planned.



Figure 7: Linear Fresnel collector (Ausra)

Power Towers

Power towers utilize a field of tracking mirrors, called heliostats, which reflect the sun's rays to a receiver located on top of a tall, centrally located tower (see Figure 8). The solar energy is absorbed by pressurized water or molten salt working fluid flowing through the receiver.

The operating temperature is higher than for line-focus collectors (parabolic troughs and linear Fresnel) but lower than for a dish (see below). Power towers can be coupled with a molten salt energy storage system, allowing energy to be stored at 1050°F. When needed, hot salt is removed from the storage tank and used to generate steam to drive a conventional Rankine steam-turbine power block. A 10 MW power tower has been built in Spain (where three more are under development, one of which is slated to have sixteen-hour molten salt storage), and another is under development in South Africa. Like other collectors that provide heat to a Rankine steam cycle, heat rejection is needed to condense the steam, and this can be air or water cooling, or a hybrid. Some studies have found that this technology has potential for lower costs than line-focus collectors, but this is only for large plant sizes. Because of their higher operating temperatures, the performance of tower systems is somewhat less affected by the higher condenser temperatures associated with dry cooling than line focus technologies.



Figure 8: 10 MW power tower pilot project, Barstow, CA

Dish/Engine Systems

As shown in Figure 9, this concept uses a field of individual parabolic-shaped dish reflectors that each focus sunlight onto an engine/generator that uses the Stirling thermodynamic cycle to directly produce electricity without producing steam. Because it tracks the sun in two axes, it captures the maximum amount of direct (or beam) solar radiation throughout the day. Because of its high concentration ratio, it can achieve very high temperatures (about 1452°F) and high efficiencies, converting over 30% of the sunlight to electrical energy.²⁰ Individual dish/engine units currently range from 1 to 25 kW in size. Power plants of any size can be built by installing fields of these systems. They can also be installed on uneven land.



Figure 9: Prototype 150 kW dish/Stirling power plant at Sandia National Laboratory

There are no commercial dish installations yet, but two large systems are being planned for southern California. Efforts are underway to minimize the cost and maximize the

reliability of the Stirling engines. The engines are air-cooled. Their high operating temperatures allow high efficiencies without water cooling, and no water is needed other than for mirror cleaning. From a water use perspective, dishes are well suited for operation in regions with minimal available water.

However, unlike the other CSP technologies discussed here, this technology does not easily lend itself to thermal storage, and so these systems are designed to provide electricity only when the sun is shining. This is a disadvantage to utility scale production in markets where firm generation is required and when the peak load period extends into the evening hours.²¹

Comparison of Water Usage for Different CSP Cooling Options

Because of water limitations, dry cooling and hybrid wet/dry cooling systems are being implemented and considered for both fossil and CSP generating plants. The technical challenges and performance limitations facing CSP are comparable to those of new fossil and nuclear power generating plants.

Dry cooling methods are increasingly common for thermal power plants. The disadvantages of dry cooling are higher capital costs, higher auxiliary operating power requirements, fan noise, and an overall lower plant performance, especially on hot days, when the peak power is needed most.²² The relative cost impact to CSP is similar to that of fossil power plants.

In a Rankine steam cycle, heat is input at a high temperature (the source temperature) and rejected at a low temperature (the sink temperature). The difference between the heat input and the heat rejected is the work done by the turbine. The efficiency of the cycle (the ratio of the turbine work done to the heat input) is a function of the difference between the source and sink temperatures. Lowering the sink temperature will in general increase the cycle efficiency.

An air-cooled plant will operate at a lower efficiency than a water-cooled plant. Plants that heat the steam to a higher temperature will be less susceptible to changes in the sink temperature. Thus the performance of power tower which operates at a higher steam temperature will be penalized less by air cooling than current trough plants or linear Fresnel designs. Dry cooling when employed for any of these plants will reduce water consumption to zero for the heat rejection system of a Rankine power system, requiring only a minimal amount of water for boiler blowdown, mirror washing and miscellaneous domestic plant uses. A dry-cooled trough plant requires about 80 gal/MWh for cycle makeup and mirror washing.²³ This compares to a wet-cooled plant that requires 800 gal/MWh.⁵

Based on thermodynamic principles, a water-cooled linear Fresnel reflector plant which generates steam directly in the heat collection tube, is estimated to require somewhat more water than a trough plant owing to its lower operating temperature and reduced cycle efficiency (greater heat rejection per MWh of electricity). Conversely, a power

tower with a conventional Rankine cycle would presumably use somewhat less water, approximately 600 gal/MWh similar to a coal plant, by virtue of its higher operating temperature and efficiency.

Hybrid wet-dry systems have been used which allow the plant to maintain design or near-design performance, albeit at a higher cost for the cooling system (compared to water cooling), while having much lower water usage than a wet evaporative cooling system.

Once-through Water Cooling

Once-through water cooling returns all of the withdrawn water to the source. Although it does not consume any water in the cooling process, it does increase the temperature and hence the evaporation rate from the body of water. This cooling method is limited in application and is not typically available for a solar power plant. It is also becoming more restricted in California, for example, because of the potential environmental consequences of returning water at an elevated temperature to the environment, and potential mortality of aquatic life due to impingement where the fish are trapped against the intake structure and entrainment, which means organisms are pulled through the cooling system.²⁴

Evaporative Water Cooling

The most common cooling method for new power plants is evaporative cooling. This is an economical and high performing power plant cooling technique. The waste heat energy dissipated from the power plant is rejected to the air via evaporation of the cooling water. Typically the evaporation takes place in a cooling tower. This method consumes a considerable amount of water. On a national average, the amount of water consumption of all thermal power generation, using both once-through and evaporative cooling, is approximately 470 gal/MWh.²⁵

The water treatment chemicals and minerals contained in the water being evaporated become concentrated over time, which requires a portion of the cooling water to be drained to remove particulates and salts. This discharge (called “blowdown”) is a potential source of environmental hazard due to the high concentrations of salts. Also, some concern must be given to water with treatment chemicals which drifts into the ambient air and can be source of PM10 (particulates less than 10 microns in diameter) pollution, which is restricted by regulations.²⁶

Parabolic trough power plants in production today use evaporative water cooling and consume roughly the same amount of water as a coal-fired or nuclear power plant, using recirculating evaporative cooling. A typical parabolic trough plant with wet cooling uses about 800 gal/MWh (780 for evaporation and water make-up, and 20 for mirror washing). These values compare to 500 gal/MWh for a stand-alone steam plant and 200 gal/MWh for a combined-cycle natural gas plant.^{1, 3, 4}

Dry Cooling

Dry cooling is becoming more prevalent in new power plants because of various state and federal water limitations. Dry cooling uses very little water. All of the waste heat from the power plant is rejected to the air. However, a significant temperature difference is needed to provide adequate heat exchange, and so the condenser temperature is about 30-50 F higher than the ambient air temperature. This results in a higher condensate temperature on hotter days which, in turn, raises the condenser pressure causing the steam turbine to be less efficient, see Figure 10. Dry cooling systems are more expensive and result in lower plant thermal efficiency, especially in hot climates and on hot days—typically when and where peak power is most in need.²⁷

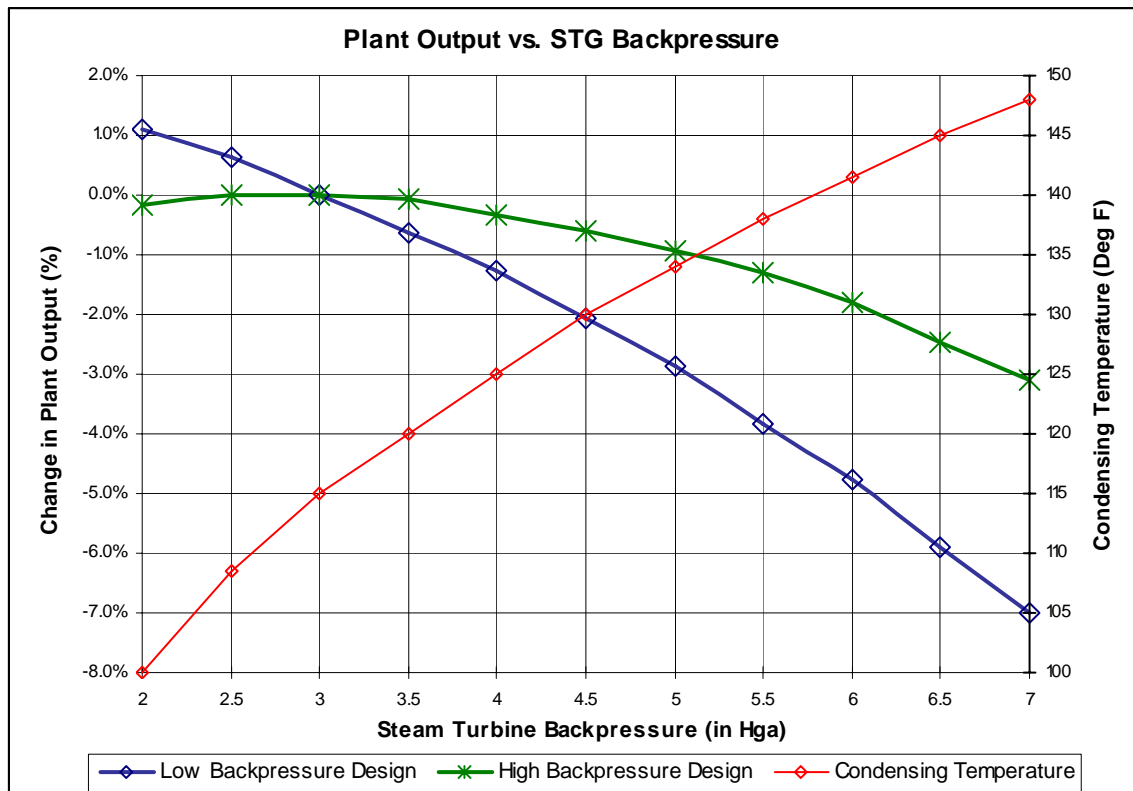

Figure 10: Plant output as a function of condensing temperature and turbine back pressure for a dry cooled plant optimized for low and high back pressure conditions

With dry cooling, the most straightforward way to minimize water use is to route exhaust steam directly to air-cooled condensers (ACCs). Typically the steam passes through an array of tubes and air is blown by a fan across the array. These systems can require considerable fan power.

A comparison of the performance and economics of a water-cooled trough plant located in Daggett, California to an air-cooled one showed that the performance of the air-cooled

system dropped off significantly at ambient air temperatures above 100°F.²⁸ The air-cooled plant provided about 5% less electric energy on an annual basis than the water-cooled plant, because of reduced performance on hot summer days. The electricity cost for the air-cooled plant was 7 to 9% higher than for the water-cooled plant. Thus air cooling of a trough plant can be used to minimize water use, but at a 7 to 9% cost penalty.

It is important to note that the impact of air cooling on levelized electricity cost depends on plant location. Air cooling of a trough plant located in New Mexico, for example, is estimated to raise the cost of electricity by only about 2% because the highest daytime temperatures at the site are significantly lower than those in the Mojave Desert.²⁹

An analysis of a 250 MW plant design in Daggett, California looked at the performance penalties of dry cooling for both a parabolic trough power plant producing 700°F steam and a power tower plant producing 1000°F steam.³⁰ It showed a 5% performance penalty for a trough plant and less than a 2% penalty in the power tower plant. The study concluded that the drop in annual electric output for an air-cooled trough plant is 4.6% compared to 1.3% for the power tower. But the report also looked at the impact during the hottest 1% of the operating hours. For those hours, the air-cooled trough plant suffered a 17.6% drop in performance, whereas the power tower plant suffered a 6.3% drop in performance. If electricity is priced very high during those periods, the financial impact could be significant. Regarding capital costs, the study found that a dry cooling system costs about 3 times that of a water-cooling system.

Lower temperature plants will have an inherent thermodynamic performance penalty. In a separate study, a model comparison of a 700°F and a 1000°F steam plant indicated that the performance degradation at a high ambient temperature (110°F) would be 14% and 13% respectively.³⁰ When plotted over the range of temperatures for Daggett, California, the annual MWh output would be about 0.5% less for the trough plant using dry cooling.

Another study concluded that if the solar field is increased in size to offset the reduced steam cycle efficiency, the resulting net present value (NPV) impact is less than if the solar field is unchanged.¹⁰ The increased solar field allows for higher steam production to offset the higher backpressure during high ambient temperature periods.

No analyses are yet available for a linear Fresnel system. Current designs operate at a lower temperature than a trough plant; therefore, one would expect a somewhat greater performance penalty from dry cooling.

Hybrid Wet/Dry Cooling

Hybrid wet/dry cooling systems can be divided into two broad categories: those aimed at plume abatement and those aimed at reducing water consumption. Plume abatement involves reducing the water vapor plume from a wet cooling tower to eliminate its appearance or to avoid winter icing on nearby roads. It is generally not an issue at CSP plants, which are typically located in dry, remote areas. Of greater interest for CSP plants

are hybrid designs that reduce water consumption compared to wet cooled plants and enhance performance in warm weather compared to dry-cooled plants. Hybrid systems typically either involve separate dry and wet units that operate in parallel or use water to evaporatively cool the air going to the air-cooled condenser.

The parallel cooling system is shown in Figure 11. Here a dry cooling system is the primary heat rejection system, and it consumes no water. The dry cooling system is used exclusively for the majority of the time. On hot days, its performance is enhanced by routing a portion of the steam leaving the turbine to a separate wet cooling system which is only rejecting a portion of the total waste heat. By reducing the load on the air-cooled condenser, the dry unit can bring the condensing steam temperature closer to the design condenser temperature on hotter days. A hybrid system uses a fraction of the water that a traditional wet cooling system would use, and the turbine performance can be maintained at or close to design conditions. Such a system would have a small wet cooling tower and would typically have a smaller air-cooled condenser than an air-cooled plant. Although it is more expensive than a water-cooled plant, it should be less expensive than an air-cooled plant.¹⁰

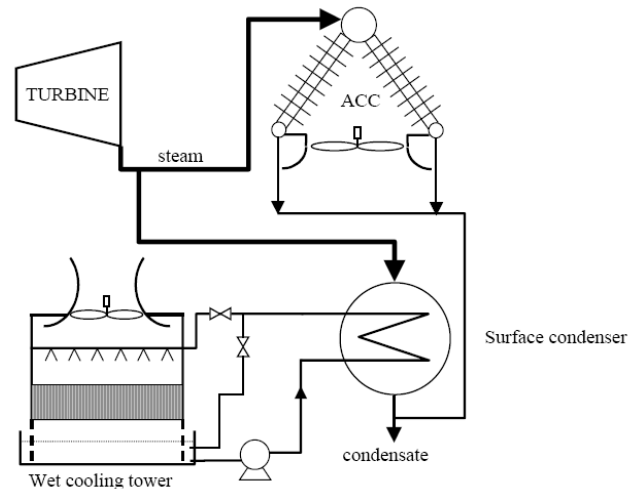

Figure 11: Hybrid wet/dry parallel cooling system (PCS)

An analysis was performed to compare the parallel cooling system design to simple dry and wet cooling for a parabolic trough plant in the Southwestern United States.³¹ For the wet-cooled runs, plant performance was found to be relatively independent of ambient temperature. For the dry-cooled cases, performance dropped off at temperatures above 100°F. For various hybrid cases over 97% of the performance can be obtained with only 10% of the water usage and 99% of the performance can be obtained at half the water usage. Figure 12 provides a graphical summary of performance of the PCS plant as a function of how much water is used. The data points are labeled by the operating pressure of the condenser that the cooling system can maintain at design conditions. A larger wet section of the hybrid cooling system will consume more water, but can maintain a lower backpressure and hence higher annual power output. The design operating condenser pressures of the various hybrid systems are expressed in inches of mercury absolute (in

HgA). One inch of mercury absolute is approximately equal to 0.5 psia. Each of the data points is expressed as a fraction of the value for the wet-cooled plant.

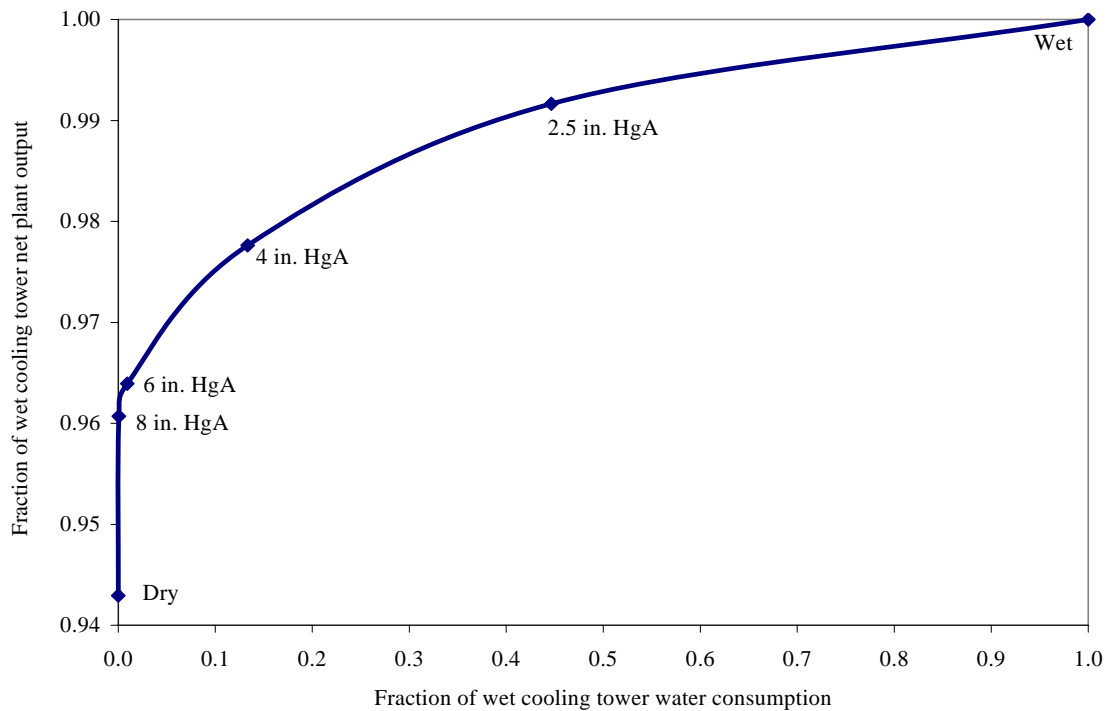

Figure 12: Power plant output as a fraction of the output for an evaporatively cooled plant vs. the fraction of water consumed.

Table 1: Net Present Value for Alternative Cooling Technologies relative to Wet Cooling.³²

	Dry Cooling Technology		Hybrid Cooling Technology	
	Same Solar Field Size	Solar Field Size Increased	Same Solar Field Size	Solar Field Size Increased
Annual Net Generation Impact relative to Wet Cooling (MWh)	-45,162	0	-27,756	0
Annual Revenue Impact relative to Wet Cooling	-\$6,774,350	\$0	-\$4,163,410	\$0
O&M Net Present Value (NPV) relative to Wet Cooling ^b	\$12,980,000	\$12,980,000	\$5,870,000	\$5,870,000
Generation Revenue NPV Relative to Wet Cooling	-\$63,860,000	\$0	-\$39,250,000	\$0
Capital Expenses Relative to Wet Cooling ^a	\$20,497,000	\$73,497,000	\$12,930,500	\$43,930,500
Total NPV Impact relative to Wet Cooling	-\$71,100,000	-\$60,100,000	-\$46,300,000	-\$38,000,000
LCOE Impact increase over Wet Cooling (\$ / kWh)	.014	.011 ^d	.009	.007 ^d
Estimated Water Consumption ^c	43 gal/MWh		338 gal/MWh	

a The capital costs show in the table include cooling equipment, boiler feed water pumps, HTF pumps, and solar field addition for the case where the solar field size is increased.

b O&M Expenses include water treatment, operating, and water pumping costs

- c Wet Cooling water consumption compares at 865 gal/MWh. From Tables 6 and 7 of reference 32.
- d LCOE adjusted by adding increased annual revenue over constant solar field size.

Table 1 gives a financial comparison of an air cooled condenser (dry), and (hybrid) ACC parallel with a wet cooling tower, relative to evaporative cooling tower (wet). Costs of each system including capital equipment, installation, water treatment, solar field, and operation and maintenance (O&M), were considered along with the estimated performance and revenue based on historical climatology data and current value for power generated in the southern California area.

If there is water available, the PCS is a water-saving alternative. On the other hand, both a wet and dry cooling system will have to be maintained and the wet system may be cycled in and out of operation. These two facts will increase the maintenance costs of the cooling system.

Table 2 summarizes the amount of water presently consumed by power plants throughout the U.S. and the options available to CSP for reducing water consumption.

Table 2: Comparison of consumptive water use of various power plant technologies using various cooling methods

Technology	Cooling	Gallons MWhr	Perform. Penalty*	Cost Penalty**	Reference
Coal / Nuclear	Once-Through	23,000 – 27,000***			1, 3
	Recirculating	400 - 750			1, 3
	Air Cooling	50 - 65			1, 3
Natural Gas					
	Recirculating	200			4
Power Tower	Recirculating	500 - 750			(estm.)
	Combination Hybrid Parallel	90-250	1-3%	5%	10, 11
	Air Cooling	90	1.3%		9
Parabolic Trough	Recirculating	800			5
	Combination Hybrid Parallel	100-450	1-4%	8%	7, Appx. A
	Air Cooling	78	4.5-5%	2-9%	6, 9
Dish / Engine					
	Mirror Washing	20			5
Fresnel	Recirculating	1000			(estm.)

For using a less water intensive cooling technique:

* = Annual energy output loss is relative to the most efficient cooling technique.

** = Added cost to produce the electricity.

***= Majority of this amount is returned to the source but at an elevated temperature.

Alternate and Future Technologies

Another type of hybrid system evaporatively cools the air-cooled condenser on those hot days when the air cooler cannot maintain low condenser pressures. This method currently has limited commercial use. The air approaching the air-cooled condenser is cooled by water spray nozzles or by passing the air through wetted media. It is also possible to directly deluge the finned heat transfer tubes in the air coolers with a flow of water.

Performance and economic modeling of a 30 MW air-cooled parabolic trough plant near Daggett, California was done to evaluate the impact of spray nozzles for pre-cooling the air.³³ The analysis showed that water cooling is more economical over a wide range of electricity prices and water costs. Water cooling is generally favored whenever water is available because of the high cost of electricity associated with trough plants. Compared to water cooling, the spray cooling decreased annual water consumption by 32% (from 856 gal/MWh to 584 gal/MWh) and decreased the annual electric output by 3.6%. With this performance impact, economic benefit would be realized only if the cost of water was over \$13 per 1000 gal at an electricity price of \$0.10 per kWh. Typical municipal water costs are around \$4.00 per 1000 gallons, and may be lower if degraded water is used. The water-cooled system showed over 4% more cash flow than the air-cooled system.

Another option is to use an indirect air-cooling system called a Heller cycle. In this design, the air-cooled condensers are replaced by a combination of a direct contact condenser and an array of water-to-air heat exchangers. Condensate is cooled by passing the water through the air-to-water heat exchangers, and the cooled water is then used to condense the steam in a direct contact condenser. (This direct contact condenser can be a conventional design or can be an advanced design using a structured packing approach patented by NREL.) The Heller cycle might provide LECa reduction in leveled electricity cost compared to an air-cooled plant, but the costs would depend on plant size and they are too uncertain to come to a conclusion at this time.³⁴

Current research and development are exploring new technologies which, if realized, could improve efficiencies while reducing water use. Advanced high-temperature heat transfer fluids, for example, could eliminate the thermodynamic performance penalties of dry cooling on trough and linear Fresnel systems. Advanced power towers are being designed for higher operating temperatures that could allow the use of gas turbines instead of steam turbines, possibly eliminating the need for cooling water.³⁵

Summary

Utilities are showing increasing interest in the deployment of concentrating solar power plants to meet the requirements of state renewable electricity standards. Dish systems which already use air cooled engines, need only water for mirror cleaning. Troughs, linear Fresnel, and power towers use the heat of the sun to power conventional Rankine steam cycles. As with fossil and nuclear-power plants, water cooling is preferred to

minimize cost and maximize cycle efficiency. However, there are concerns about mounting water shortages and air pollution associated with evaporative cooling towers. Analyses indicate that the use of either direct or indirect dry cooling can eliminate over 90% of the water consumed in a water-cooled concentrating solar power plant. However, a combination of a reduction in power output and the added cost of the air cooling equipment is estimated to add roughly 2 to 10% to the cost of generating electricity, depending on the plant location and other assumptions. The use of hybrid parallel wet/dry coolers is estimated to reduce the energy cost penalty to below that of air cooling alone while still saving about 80% of the water compared to a water-cooled plant.

References

¹ National Energy Technology Laboratory (2006). Estimating Freshwater Needs to Meet Future Thermoelectric Generation Requirements. DOE/NETL-2006/1235. pp. D-1 and F-2. Note the values provided in this text are an approximation of the national averages for coal fired supercritical and subcritical with wet FGD. The ranges for water consumption of coal fired plants are estimated from the box plots on p F-1 and F-2 to be between 400 and 800 gal / MWh. The averaged surveyed values for power plants nationwide, listed by plant type, cooling method, and FGD method is on page D-1.

² The Resources Agency of California. (September 2, 2003). Background information and staff recommendation on power plant water use. Memorandum from CEC to Integrated Energy Policy Report Committee.

³.U.S. Department of Energy (December, 2006). Energy Demands on Water Resources. Report to Congress on the Interdependency of Energy and Water. P. 38 Table V-1.

Plant-type	Process	Water intensity (gal/MWh.)			
		Steam Condensing		Other Use	
		Withdrawal	Consumption	Withdrawal	Consumption
Coal	Mining				5-74
	Slurry			110-230	30-70
Fossil/ biomass/ waste	OL Cooling	20,000- 50,000	~300	~30**	
	CL Tower	300-600	300-480		
	CL Pond	500-600	~480		
	Dry	0	0		
Nuclear	Mining and Processing				45-150
Nuclear	OL Cooling	25,000- 60,000	~400	~30**	
Nuclear	CL Tower	500-1,100	400-720		
Nuclear	CL Pond	800-1,100	~720		
Nuclear	Dry	0	0		
Geothermal Steam	CL Tower	~2000	~1400	Not available	
Solar trough	CL Tower	760-920	760-920	8**	
Solar tower	CL Tower	~750	~750	8**	
Other					
Natural Gas	Supply				~11
Natural Gas CC	OL Cooling	7,500- 20,000	100	7-10**	
	CL Tower	~230	~180		
	Dry	0	0		
Coal IGCC*	CL Tower	~250	~200	7-10 + 130 (process water)**	
Hydro- electric	Evaporation				4500 (ave)

Mining of coal consumes 0.07 to 0.26 billion gallons per day

Thermoelectric power generation withdraws 136 billion gallons per day and consumes 3.3 billion gallons per day

OL = Open loop cooling, CL = Closed Loop Cooling, CC = Combined Cycle

*IGCC = Integrated Gasification Combined-Cycle, includes gasification process water

Other Use includes water for other cooling loads such as gas turbines, equipment washing, emission treatment, restrooms, etc.

**References did not specify whether values are for withdrawal or consumption.

The general calculation for estimating water consumption of a typical thermal power plant is as follows. Given a steam turbine net efficiency of 37%, the heat rejection per MWh will be:

$$3.412 \times 10^6 \text{ btu/MWh} \times [(1/37\%) - 1] = 5.81 \times 10^6 \text{ BTU/hr}$$

Assume 90% of heat is rejected by latent heat of evap, latent heat capacity of water to be 1000 BTU/lb, and water density of 8.33 lb/gal:

$$5.81 \times 10^6 \text{ BTU/hr} \times 90\% / (1000 \text{ BTU/lb} \times 8.33 \text{ lb/gal}) = 628 \text{ gal/MWh evaporation}$$

⁴ DOE (2006). p. 38 Table V-1 and NETL (2006) p. D-1.

From the calculation above (Endnote 3), approximate water consumption rate for a combined cycle plant is 630 gal (170/500) = 255 gal / MWh plus aux loads.

In the table of NETL(2006) p. D-1, natural gas combined cycle (NGCC) plants with recirculating cooling consume on average 130 gal / MWh. The surveyed ranges of NGCC consumption rates are not provided.

⁵ Cohen, G. E., Kearney, D. W., & Kolb, G. J. (1999). Final Report on the Operation and Maintenance Improvement Program for Concentrating Solar Power Plants. Usage listed is raw water usage and assumed to be withdrawal rate. Consumption rate approximated from 90% of the withdrawal rate. p. 30-31

⁶ WorleyParsons. *Wet and Dry Cooling Options for a 250 MW Thermal Plant.*

⁷ WorleyParsons. (2008). FPLE - Beacon Solar Energy Project: Dry Cooling Evaluation. WorleyParsons Report No. FPLS-0-LI-450-0001. WorleyParsons Job No. 52002501.

⁸ *New Mexico Central Station Solar Power: Summary Report*. EPRI, Palo Alto, CA, PNM Resources, Inc., Albuquerque, NM, El Paso Electric Co., El Paso, TX, San Diego Gas & Electric Co., San Diego, CA, Southern California Edison Co., Rosemead, CA, Tri-State Generation & Transmission Association, Inc., Westminster, CO, and Xcel Energy Services, Inc., Denver, CO: 2008. 1016342.. p. 5-7.

⁹ WorleyParsons. *Wet and Dry Cooling Options for a 250 MW Thermal Plant*. and

GateCycle models for parabolic trough and central receiver plants which use air cooled condensers compared the relative performance at 70 F and 108 F for the two plant designs as follows:

Parabolic Trough Plant: 1450 psig / 710 F / 710 F Rankine cycle

70 F ambient temperature	108 F ambient temperature
139.5 MWe gross plant output	119.9 MWe gross plant
0.374 gross cycle efficiency	0.321 gross cycle efficiency
0.082 bar condenser pressure	0.250 bar condenser pressure
0.860 hot day output / design day output	
0.860 hot day efficiency / design day efficiency	

Central Receiver Plant: 1850 psig / 950 F / 950 F Rankine cycle

70 F ambient temperature	108 F ambient temperature
139.9 MWe gross plant output	121.7 MWe gross plant
0.412 gross cycle efficiency	0.361 gross cycle efficiency
0.082 bar condenser pressure	0.252 bar condenser pressure
0.870 hot day output / design day output	
0.875 hot day efficiency / design day efficiency	

Nominally, both plants show a 5 percent reduction in gross output and gross efficiency if the ambient temperature increases from the design point of 70 F to a hot day temperature of 108 F.

This is not a completely representative set of annual performance analyses, and the auxiliary energy demands of the pumps and fans are not included here. However, the trends in the above figures indicate a performance penalty for a parabolic trough plant compared to a tower plant is not as significant as shown in the above reference.

¹⁰ WorleyParsons. (2008). FPLE - Beacon Solar Energy Project: Dry Cooling Evaluation. WorleyParsons Report No. FPLS-0-LI-450-0001. WorleyParsons Job No. 52002501. Table 8.

¹¹ PAC SYSTEM® Installation List
GEA Power Cooling Systems, LLC
143 Union Blvd., suite 400
Lakewood, CO 80228
Telephone: (303) 987-0123

Station Owner (A/E)	Size (MWe)	Steam Flow (Lb/Hr)	Turbine BP (in HgA)	Design Temp (Deg F)	Year	Remarks
Exeter Energy L. P. Project	30	196,000	2.9	75	1989	(W-T-E)
Streeter Generating Station	40	246,000	3.5	50	1993	(Combined Cycle)
Tucuman Power Station	150	1150000	5	99	1997	(Combined Cycle)
Grumman	13	105700	5.4	59	1997	(Combined Cycle)
SEMASS WTE Facility	54	407500	3.5	59	1999	(W-T-E)

Goldendale Energy Project	110	678000	4.5	90	2000	(Combined Cycle)
Comanche, Unit 3	750	3374300	3.73	97	2006	(Coal Fired)
Afton Generating Station	100	594981	5	98	2006	(Combined Cycle)

¹² Appendix A.

¹³ Kelly, B. (2006). *Nexant Parabolic Trough Solar Power Plant Systems Analysis; Task 2 Comparison of Wet and Dry Rankine Cycle Heat Rejection*. National Renewable Energy Laboratory, NREL/SR-550-40163 and

Appendix A.

¹⁴ From NREL analysis– selecting the best land area, CSP projects could provide about 11,000,000 MW or 26,400,000 GWh. To put this in context, the entire U.S. uses about 4,000,000 GWh per year. Thus, on 9.2 percent of the southwestern land CSP projects could generate over 6 times the power needed by the U.S. This means that on less than 1.5 percent of the land in the southwest, CSP projects could theoretically generate as much energy as the country uses.

State	Total Land Area (mi ²)	Land Area – Best for CSP projects (mi ²)	Solar Capacity (MW)	Solar Generation Capacity (GWh)
AZ	113,600	13,613	1,742,461	4,121,268
CA	156,000	6,278	803,647	1,900,786
CO	103,700	6,232	797,758	1,886,858
NV	109,800	11,090	1,419,480	3,357,355
NM	121,400	20,356	2,605,585	6,162,729
TX	261,900	6,374	815,880	1,929,719
UT	82,200	23,288	2,980,823	7,050,242
Total	948,600	87,232	11,165,633	26,408,956

Land area deemed “best” for CSP is from an analysis that has no primary use today, excludes land with a slope greater than 1 percent, does not count sensitive lands, and has a solar resource of 6.75 kWh/m²/day. Solar capacity assumes 5 acres/MW and a 27 percent annual capacity factor.

¹⁵ The Resources Agency of California. (September 2, 2003). Background information and staff recommendation on power plant water use. Memorandum from CEC to Integrated Energy Policy Report Committee.

¹⁶ Cohen, Kearney & Kolb (1999)

¹⁷ CEC, California Energy Commission (2002). Comparison of Alternate Cooling Technologies for California Power Plants: Economic, Environmental and Other Tradeoffs, Public Interest Energy Research, 500-02-079F, February 2002.. pp. 1-1 – 1-3.

¹⁸ *US DOE Solar Technologies Program Multi-Year Plan 2008-2012*

¹⁹ National Renewable Energy Laboratory. Parabolic Trough FAQ’s. Mirror washing use is approximately 20 gal/MWh. March 22, 2008 from: <http://www.nrel.gov/csp/troughnet/faqs.html#water>

²⁰ Sandia National Laboratory (February 12, 2008). Sandia, Stirling Energy Systems set new world record for solar-to-grid conversion efficiency. News release retrieved March 30, 2008 from: <http://www.sandia.gov/news/resources/releases/2008/solargrid.html>

²¹ WorleyParsons. (2008). FPLE - Beacon Solar Energy Project: Dry Cooling Evaluation. WorleyParsons Report No. FPLS-0-LI-450-0001. WorleyParsons Job No. 52002501.

²² Kelly, B. (2006). *Nexant Parabolic Trough Solar Power Plant Systems Analysis; Task 2 Comparison of Wet and Dry Rankine Cycle Heat Rejection*. National Renewable Energy Laboratory, NREL/SR-550-40163

²³ WorleyParsons (2008). P 15 and 16 show the water requirements for a dry cooled plant of 79 acre-ft per year and the corresponding annual energy production of 557,365 MWh.

²⁴ California Energy Commission (2001), Environmental Performance Report of California's Electric Generation Facilities. P700-01-001, July 2001. P. 39

²⁵ Torcellini, P.; Long, N.; Judkoff, R. (2003). *Consumptive Water Use for U.S. Power Production*. NREL/TP-550-33905.

²⁶ USEPA. AP-42. Compilation of Air Pollutant Emission Factors. Ch 13. Retrieved from : <http://www.epa.gov/ttn/chief/ap42/ch13/final/c13s04.pdf>

²⁷ Maulbetsch, J. S., and M. N. DiFilippo. 2006. *Cost and Value of Water Use at Combined-Cycle Power Plants*. California Energy Commission, PIER Energy-Related Environmental Research. CEC-500-2006-034.

²⁸ Kelly, B. (2007). *Comparison of Wet and Dry Rankine Cycle Heat Rejection*. Nexant, Inc. A Bechtel-Affiliated Company. San Francisco, California.

²⁹ *New Mexico Central Station Solar Power: Summary Report*. EPRI, Palo Alto, CA, PNM Resources, Inc., Albuquerque, NM, El Paso Electric Co., El Paso, TX, San Diego Gas & Electric Co., San Diego, CA, Southern California Edison Co., Rosemead, CA, Tri-State Generation & Transmission Association, Inc., Westminster, CO, and Xcel Energy Services, Inc., Denver, CO: 2008. 1016342.. p. 5-7

³⁰ WorleyParsons. *Wet and Dry Cooling Options for a 250 MW Thermal Plant..*

and

Provided by Bruce Kelly (email correspondence):

GateCycle models for parabolic trough and central receiver plants which use air cooled condensers compared the relative performance at 70 F and 108 F for the two plant designs as follows:

Parabolic Trough Plant: 1450 psig / 710 F / 710 F Rankine cycle

70 F ambient temperature	108 F ambient temperature
139.5 MWe gross plant output	119.9 MWe gross plant
0.374 gross cycle efficiency	0.321 gross cycle efficiency
0.082 bar condenser pressure	0.250 bar condenser pressure
0.860 hot day output / design day output	
0.860 hot day efficiency / design day efficiency	

Central Receiver Plant: 1850 psig / 950 F / 950 F Rankine cycle

70 F ambient temperature	108 F ambient temperature
139.9 MWe gross plant output	121.7 MWe gross plant
0.412 gross cycle efficiency	0.361 gross cycle efficiency
0.082 bar condenser pressure	0.252 bar condenser pressure
0.870 hot day output / design day output	
0.875 hot day efficiency / design day efficiency	

Nominally, both plants show a 5 percent reduction in gross output and gross efficiency if the ambient temperature increases from the design point of 70 F to a hot day temperature of 108 F.

This is not a completely representative set of annual performance analyses, and the auxiliary energy demands of the pumps and fans are not included here. However, the trends in the above figures indicate a performance penalty for a parabolic trough plant compared to a tower plant is not as significant as shown in the above reference.

³¹ Appendix A.

³² WorleyParsons. (2008). FPLE - Beacon Solar Energy Project: Dry Cooling Evaluation. WorleyParsons Report No. FPLS-0-LI-450-0001. WorleyParsons Job No. 52002501. pp. 15-17, Tables 6, 7 and 8.

³³ Morris, P., Maulbetsch, J.S., DiFilippo, M.N. (2005). Spray Enhancement of ACC Performance at Crockett Cogeneration Plant. CEC/EPRI Advanced Cooling Strategies/Technologies Conference. Sacramento, CA.

³⁴ "Engineering and Economic Assessment of Advanced Air-Cooling Technologies for Steam-Rankine Power Systems," by Bharathan, et al.

The study compares a conventional air-cooled plant to a Heller cycle. The total capital cost of the Heller cycle components was \$10.5 million compared to the ACC cost of \$7.1 million. They claim the Heller cycle allows some performance improvement due to lower condenser pressures (less back pressure on the turbine), especially on hot days when the cooling water circulation rate can be increased. Table 5.4 (pg. 49) shows an overall economic advantage for Heller due to an improvement in the heat rate. But on pg. 50, they refer to the reduced condenser pressure in the Heller cycle and conclude, "However, the overall economics of this advantage are uncertain because of the lack of domestic capital and operating costs and performance information for this type of steam condensing system."

³⁵ Angelino, G., Invernizzi, C. Binary conversion cycles for concentrating solar power technology, *Solar Energy* In Press, Corrected Proof, , Available online 20 February 2008. Retrieved from: (<http://www.sciencedirect.com/science/article/B6V50-4RW9H0T-1/1/378ad00ada48ff5adcae3196f76d937a>)

and

Heller P., Pfander M., Denk T., Tellez F., Valverde A., Fernandez J., Ring A. Test and evaluation of a solar powered gas turbine system (2006) *Solar Energy*, 80 (10), pp. 1225-1230. Retrieved from Science Direct Database

Appendix A

Concentrating Solar Power Commercial Application Study: Reducing Water Consumption of Concentrating Solar Power Electricity Generation

Appendix A

Further analysis stemming from the study conducted in the reference 1 of this Appendix, also referenced in footnote 13 of the main report evaluated the impact of hybrid cooling.

¹³Kelly, B. (2006). *Nexant Parabolic Trough Solar Power Plant Systems Analysis; Task 2 Comparison of Wet and Dry Rankine Cycle Heat Rejection*. National Renewable Energy Laboratory, NREL/SR-550-40163

1. Introduction

The plant design parameters used for this analysis are as follows:

- 274 MWe gross plant output
- Two Rankine cycles, each with a nominal gross rating of 137 MWe
- Two collector fields, each with an aperture area of 1,030,000 m²
- Two thermal storage systems, each with a nominal capacity of 1,096 MWht. The storage capacity is sufficient to operate the Rankine cycle at full load for 3 hours, and the energy from storage is dispatched such that the Rankine cycle is operated at full load for the fewest number of hours each day (i.e., no load shifting)
- The 30-year solar radiation and weather file for Barstow, California is assumed to be applicable for A Southwest desert site
- The design point for the wet heat rejection system is assumed to be as follows: 2.5 in. HgA condenser pressure; 104 °F dry bulb temperature; and 64 °F wet bulb temperature.
- The design point for the dry heat rejection system is assumed to be as follows: 2.7 in. HgA turbine exhaust pressure; 2.5 in. HgA condenser pressure; and 70 °F dry bulb temperature. The 0.2 in. HgA difference between the turbine exhaust pressure and the condenser pressure is the pressure loss in the steam duct between the exhaust flange and the condenser inlet. The 70 °F dry bulb temperature is the result of the 2006 optimization study on wet and dry heat rejection systems (reference 1).

Three heat rejection systems were evaluated:

- 1) A wet system, including mechanical draft cooling towers, a surface condenser, vacuum pumps, circulating water pumps, underground circulating water pipes, a water treatment system for cooling tower makeup, and an evaporation pond for the cooling tower blowdown. A schematic diagram of the system is shown in Figure 1.
- 2) A dry system, including an air cooled condenser and vacuum pumps. A schematic diagram is illustrated in Figure 2.

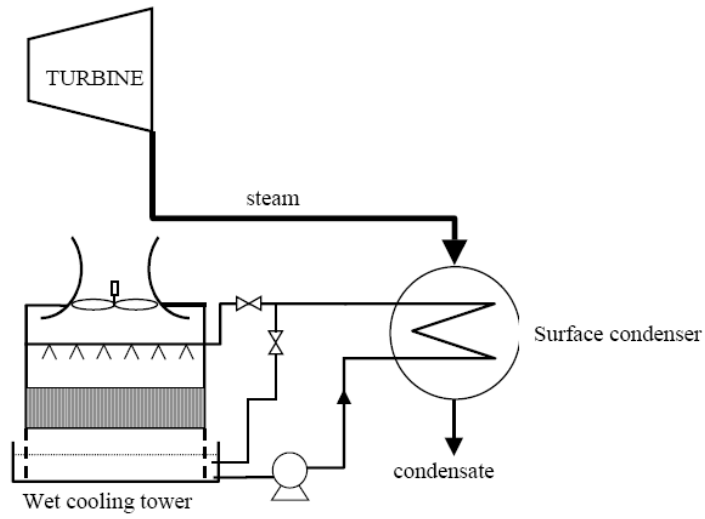

Figure 1 Schematic Diagram of Wet Heat Rejection System

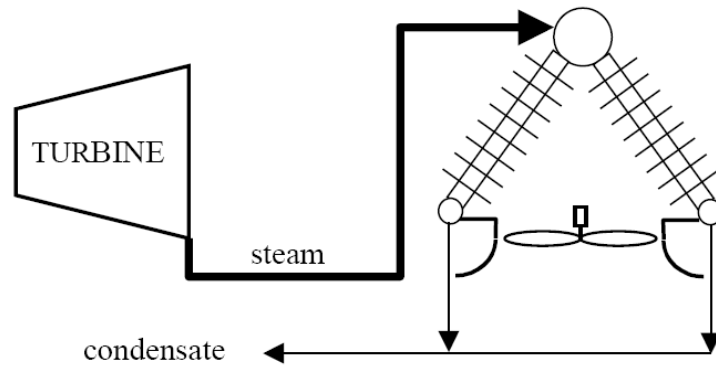

Figure 2 Schematic Diagram of Dry Heat Rejection System

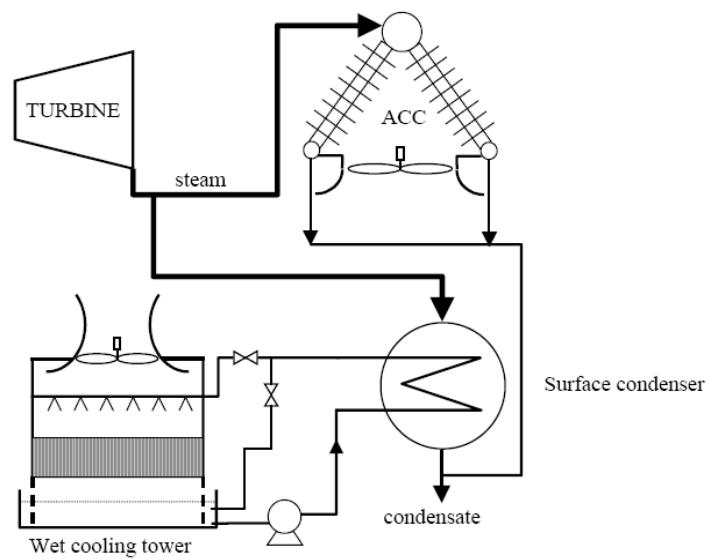

Figure 3 Schematic Diagram of Hybrid Heat Rejection System

- 3) A hybrid system, which uses an air cooled condenser in parallel with a wet, mechanical draft cooling towers. A schematic diagram of the equipment arrangement is shown in Figure 3. On high ambient temperature days, the wet system is placed in service. A portion of the turbine exhaust condenses on the surface condenser, and the balance of the flow is condensed in the air cooled condenser. The reduced thermal demand on the air cooled condenser allows a closer approach to the dry bulb temperature, which results in a lower turbine exhaust pressure than achieved with a dry system alone. The hybrid system consists of an air cooled condenser, vacuum pumps, and all of the equipment associated with the wet system, but with smaller equipment capacities than required in Item 1.

The hybrid cooling study was conducted through the following steps:

- Six performance models were developed of a 137 MWe Rankine cycle using the GateCycle program [Reference 2]; one for wet heat rejection, one for dry heat rejection, and four for hybrid heat rejection. The hybrid cases included equipment sizes sufficient to maintain maximum condenser pressures of 2.5, 4.0, 6.0, and 8.0 in. HgA throughout the year
- Calculations of the thermal output from the collector field, and the thermal input to the steam generator, were developed for each hour of the year
- For each of the 3,421 hours of solar operation each year, the thermal input to the steam generator, and the ambient temperatures, were used to calculate the steam flow rates, gross electric output, and auxiliary electric power requirements for the cooling tower fans and Rankine cycle pumps. The results were exported to an Excel file, from which the annual gross and net outputs and efficiencies were calculated.
- Capital cost estimates were developed for each of the 6 heat rejection systems.
- Operating cost estimates for the makeup water treatment system for the wet and the hybrid heat rejection systems were developed.

2. Power Plant Design

The performance model for the Rankine cycle, various design parameters for the heat rejection systems, are discussed in the following sections.

2.1 Rankine Cycle

The Rankine cycle design follows a conventional, single reheat design with 5 closed and 1 open extraction feedwater heaters. The main steam pressure and temperature are 1,465 lb_f/in² and 703 °F, respectively, and the reheat steam temperature is 703 °F. For all of the heat rejection cases, the design condenser pressure is 2.5 in. HgA.

2.2 Wet Heat Rejection

The wet heat rejection system is based on conventional, mechanical draft cooling towers. The principal design parameters include the following:

- 104 °F design dry bulb temperature; 10 percent relative humidity
- 10 °F cooling water approach to 64 °F wet bulb temperature
- 20 °F circulating water temperature range
- 224 MWt duty
- 6 cycles of concentration

The cooling tower consists of 10 cells, each with a 125 bhp fan. The circulating water flow rate is a nominal 76,000 gpm, and the makeup water flow rate is 1,930 gpm. Of the makeup water flow, 83 percent is to compensate for evaporation losses, 13 percent for blowdown, and 4 percent for drift losses.

The circulating water system includes the following:

- Two 50 percent capacity pumps, each rated at 38,000 gpm and driven by a 750 bhp electric motor
- A surface condenser, with a nominal area of 160,000 ft²
- Supply and return circulating water pipes, with a diameter is 60 inches. The distance from the cooling towers to the surface condenser is assumed to be 200 feet.

2.3 Dry Heat Rejection

The dry heat rejection system is based on a mechanical draft, air cooled condenser. The principal design parameters include the following:

- 109 °F steam condensing temperature at 70 °F dry bulb temperature (39 °F initial temperature difference)
- 2 °F condensate subcooling at condenser outlet
- 224 MWt duty

Appendix A

The cooling tower consists of 15 bays, each with a 300 bhp fan. The condensing section is fabricated from oval carbon steel tubes, with aluminum fins. The total heat transfer area, including the tubes and the fins, is approximately 5,250,000 ft².

A series of adjustments to the GateCycle operating logic were made under the following conditions:

- 1) For the dry heat rejection system, there are approximately 230 hours each year in which the combination of thermal input from the collector field and the ambient temperature would normally result in turbine exhaust pressures above the maximum allowable value of 8 in. HgA. For these hours, the thermal input to the steam generator is successively reduced in increments of 0.5 percent until the exhaust pressure decreases to 8 in. HgA. The annual thermal energy which cannot be converted to electric energy during these hours is recorded.
- 2) For the dry heat rejection system, condenser pressures below 1 in. HgA are possible on cold days, or on warm days with a small solar thermal input. To reduce the auxiliary electric demand during these hours, cooling towers fans are stopped in groups of 6 until the condenser pressure rises to at least 1 in. HgA.
- 3) For the wet heat rejection system, condenser pressures below 1 in. HgA are possible on cold days, or on warm days with a small solar thermal input. To reduce the auxiliary electric demand during these hours, cooling towers fans are stopped in succession until the condenser pressure rises to at least 1 in. HgA.

2.4 Hybrid Heat Rejection

The required duty of the wet cooling tower in a hybrid system to achieve the desired condenser pressure of 2.5, 4, 6, or 8 in. HgA throughout the year is a function of the ambient temperature distribution and the parallel performance of the wet cooling tower and the air cooled condenser during the summer. The required duties are determined by means of an annual simulation of the plant performance, discussed below in Section 3.3.

3. Annual Performance Calculations

The performance of the Rankine cycle is a function of the thermal input to the steam generator, and the ambient temperature. To estimate the annual performance of the plant, the following calculations were performed:

- 1) A weather file was compiled for a Southwest desert site, listing for each hour of the year, the dry bulb temperature, relative humidity, and direct normal solar radiation.

Appendix A

- 2) For each hour of the year, the thermal output from the collector field was calculated by the Excelergy computer program, as discussed below.
- 3) The dry bulb temperature, the relative humidity, and the thermal input from the collector field were exported to the GateCycle program. The program calculated the steam turbine expansion efficiencies, exhaust losses, gross electric output, and the auxiliary electric loads for the cooling tower fans, the feedwater pump, the condensate pump, and if applicable, the circulating water pumps. For the wet and the hybrid heat rejection systems, the makeup water flow to the cooling tower was also calculated. The calculations were repeated for each of the 3,421 hours each year in which thermal energy was available from either the collector field or the thermal storage system.
- 4) Annual sums were developed for the following parameters: thermal energy supplied to the Rankine cycle; gross plant output; fan electric energy; pump electric energy; and net electric output. From these values, annual gross and net Rankine cycle efficiencies were developed.

The thermal output from the collector field is calculated using the Excelergy program. The program, under development by the National Renewable Energy Laboratory over the past 10 years, models the performance of parabolic trough collector fields and, if applicable, the associated Rankine cycle. The model calculates the following:

- Month of the year, day of the month, hour of the day, and time before noon
- Each of the following angles: solar declination; sun elevation; sun azimuth; and collector incidence. From the collector incidence angle, an incidence angle modifier was calculated to account for the reflected flux which misses the end of the heat collection element during the midday hours
- Each of the following optical efficiencies: solar field availability; structure tracking error and twist; mirror reflectivity; geometric accuracy; mirror reflectivity, mirror cleanliness factor; and the following factors for the heat collection elements: dust on glass envelope; bellows shading; envelope transmissivity; and absorber tube absorbtivity
- Heat collection element thermal losses, including emissivity as a function of fluid temperature, and allowances for lost vacuum and lost glass envelopes
- Gross field thermal output, by multiplying the following: collector area; collector optical efficiency; and heat collection element thermal efficiency
- Net field thermal output, by multiplying the gross output by 0.9805 to account for thermal losses from the field piping

- Auxiliary electric loads for the heat transport fluid circulation pumps and the collector drive motors.

The program generates a file, of the field's net thermal output for each hour of the year.

3.1 Wet Heat Rejection

From the 3,421 hourly performance calculations, a plot of the net electric output as a function of the ambient temperature for the wet heat rejection system is shown in Figure 4. The annual net electric output for the complete 250 MWe plant is estimated to be 846,200 MWh, and the net Rankine cycle efficiency is estimated to be 36.6 percent.

As expected, the net output is essentially independent of the ambient temperature. The effect can be traced to the low relative humidity, and consequently low wet bulb temperatures, on summer days in the desert.

A majority of the data points are concentrated in the net electric output range of 270 to 280 MWe. This is a reflection of the excellent direct normal radiation at A Southwest desert site, plus the availability of energy from the thermal storage system, which maintains the Rankine cycle at, or close to, full load. Data points are not shown for net outputs below 40 MWe, as the minimum turbine output is assumed to be 15 percent of the design output.

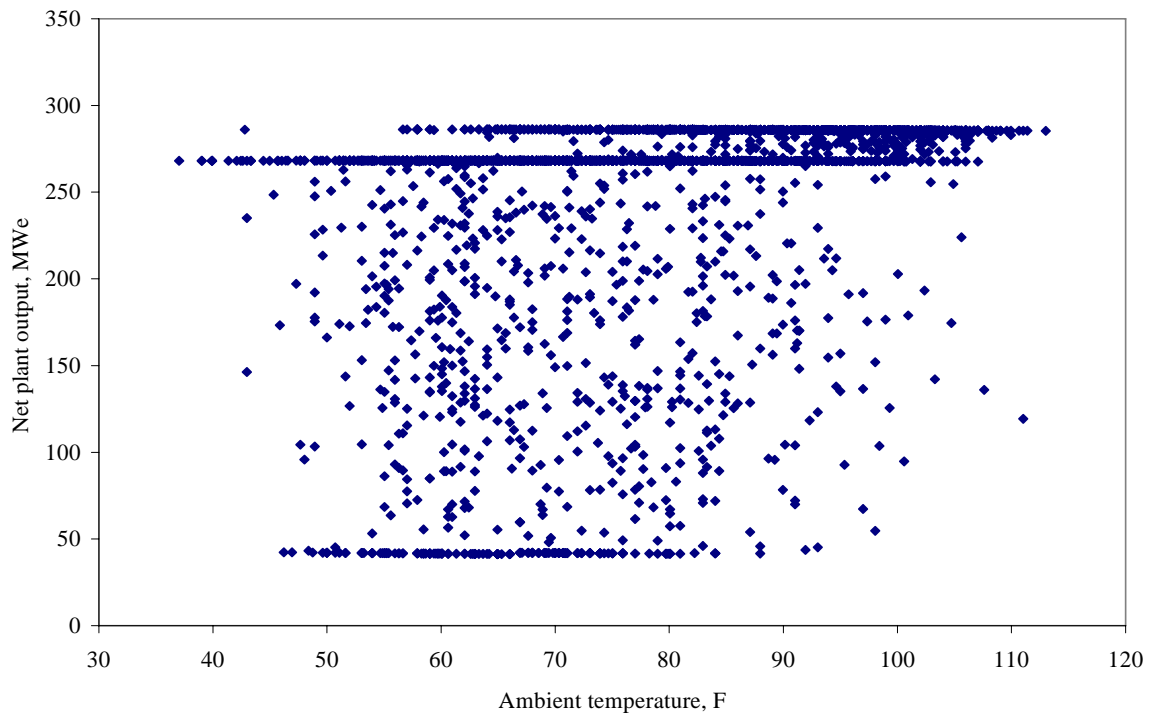

Figure 4 Net Plant Output as a Function of Ambient Temperature; Wet Heat Rejection

3.2 Dry Heat Rejection

A plot of the net electric output as a function of the ambient temperature for the dry heat rejection system is shown in Figure 5. The annual net electric output for the complete 250 MWe plant is estimated to be 797,900 MWh, and the net Rankine cycle efficiency is estimated to be 34.8 percent.

For ambient temperatures between 40 °F and 100 °F, the condenser pressure increases as the dry bulb increases, and the net plant output shows a gradual decrease. However, for ambient temperatures above 100 °F, the condenser cannot simultaneously condense the design point steam flow rate and provide a condenser pressure below 8 in. HgA. As a result, the steam flow rate must be reduced to ensure the condenser pressure remains within limits. During the one hour of the year with the highest temperature (113 °F), the plant output must be restricted to about 165 MWe.

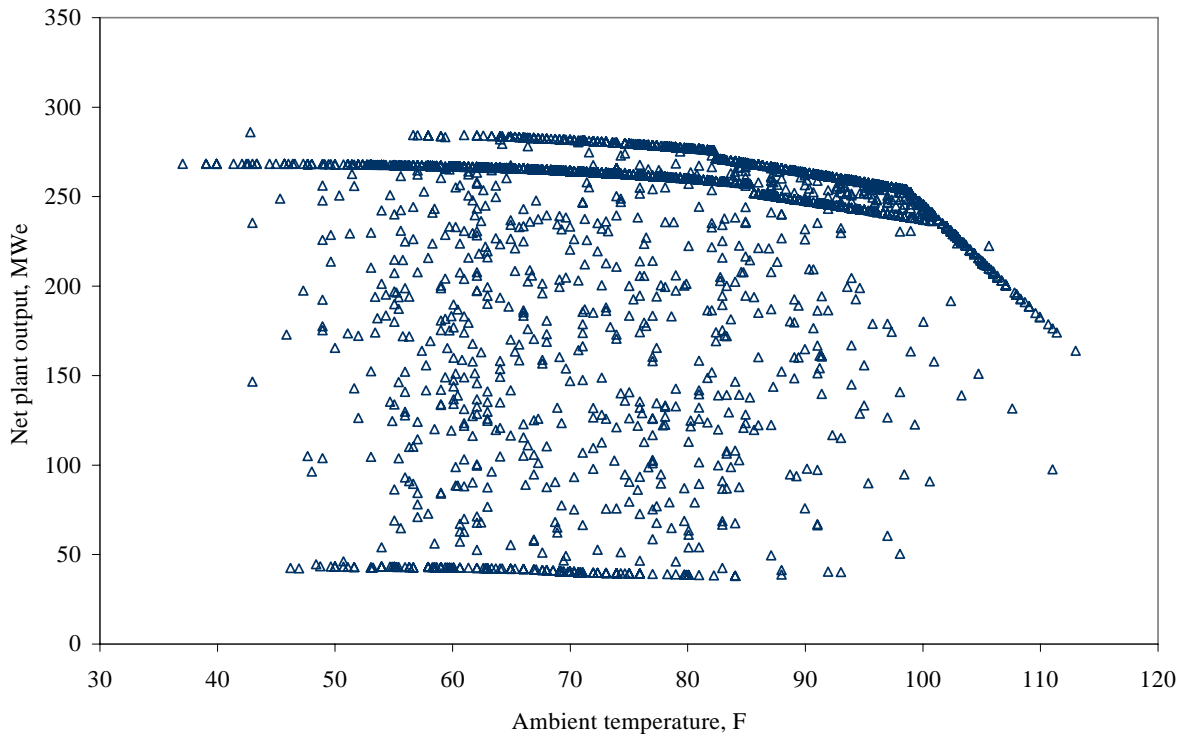

Figure 5 Net Plant Output as a Function of Ambient Temperature; Dry Heat Rejection

As with the wet cooling tower plot, data points in Figure 5 are not shown for net outputs below 40 MWe, the minimum turbine output which is 15 percent of the design output.

3.3 Hybrid Heat Rejection

For the purposes of the study, the following wet cooling tower duties in each 125 MWe plant have been selected for the hybrid tower designs:

2.5 in. HgA: 130 MWt; 4 in. HgA: 80 MWt;
 6 in. HgA: 45 MWt; and 8 in. HgA: 15 MWt.

3.4 Annual Performance Summary

A plot of the net plant output (as a fraction of the wet tower plant output) as a function of the wet cooling tower water consumption (as a fraction of the water consumption of the wet cooling tower case) is shown in Figure 6. As might be expected, the largest incremental gains occur with the first water used; i.e., switching from a dry system to the 8 in. HgA hybrid system increases the net output by 8,300 kWh per ton of water consumed. As the water consumption is increased, the performance improvements become smaller; i.e., switching from the 2.5 in. HgA hybrid system to the wet cooling tower increases the net output by only 5 kWh per ton of water consumed.

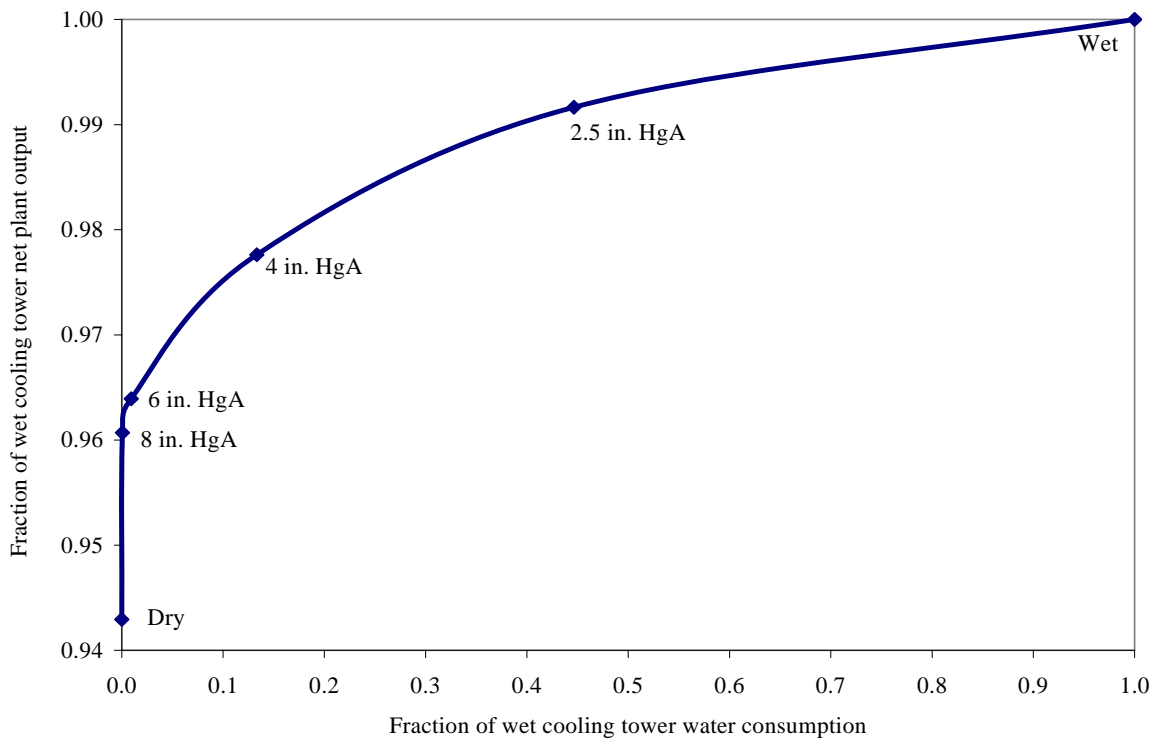

Figure 6 Net Plant Output as a Function of Wet Cooling Tower Water Consumption

Appendix A

The annual plant performance for the 6 cooling tower options is summarized in Table 1. Three trends can be noted, as follows:

- The gross and the net plant outputs both increase as the water consumption increases
- The pump energy demand is the highest for the wet cooling tower, and lowest for the air cooled condenser, due to the demands of the circulating water pumps
- The hybrid cases use the same air cooled condenser as the dry cooling tower case; thus, the fan energies for the hybrid cases are the sum of the fan energies for the dry case plus a portion of the fan energies for the wet cooling tower.

Table 1 Summary of Annual Plant Performance

	Gross turbine, <u>MWhe</u>	Pump power, <u>MWhe</u>	Fan power, <u>MWhe</u>	Net turbine, <u>MWhe</u>	Gross efficiency	Net efficiency	Makeup water, tons
Wet	875,199	19,157	8,956	846,161	0.379	0.366	2,705,132
Hybrid: 2.5 in. HgA	871,459	15,468	24,082	839,099	0.377	0.363	1,207,521
Hybrid: 4 in. HgA	858,196	13,702	19,601	827,234	0.372	0.358	360,998
Hybrid: 6 in. HgA	848,014	13,045	19,477	815,626	0.367	0.353	25,020
Hybrid: 8 in. HgA	845,290	13,002	19,390	812,903	0.366	0.352	1,803
Dry	827,262	12,977	16,413	797,872	0.361	0.348	0

6. References

- 1) “Task 2 - Comparison of Wet and Dry Rankine Cycle Heat Rejection”, Midwest Research Institute/ National Renewable Energy Laboratory Subcontract Number LDC-5-55014-01, Technical Support for Parabolic Trough Solar Technology, Nexant Inc. (San Francisco, California), July 2006
- 2) GateCycle Program, Version 5.34, GE Enter Software, Inc. and the Electric Power Research Institute