

Age, Stratigraphy, and Correlations of the Late Neogene Purisima Formation, Central California Coast Ranges

By Charles L. Powell II¹, John A. Barron¹, Andrei M. Sarna-Wojcicki¹, Joseph C. Clark², Frank A. Perry³, Earl E. Brabb⁴, and Robert J. Fleck¹

Abstract

The Purisima Formation is an important upper Miocene and Pliocene stratigraphic unit in central California, cropping out from the coast at Point Reyes north of San Francisco to more extensive exposures in the Santa Cruz Mountains to the south. The fine-grained rocks in the lower parts of the Purisima Formation record a latest Miocene transgressive event, whereas the middle and upper parts of the formation consist of increasingly clastic-rich siltstones and sandstones resulting from uplift of adjacent coastal regions and the Sierra Nevada during Pliocene transgressive and regressive sea-level events. Exposures of the Purisima occur in three different, fault-bounded, structural blocks—the Santa Cruz, Pigeon Point, and Point Reyes tectonic blocks—that complicate correlations and regional age assignments. We summarize and compare published and new biostratigraphic and geochronologic data for various exposures of the Purisima Formation on the basis of mollusks, diatoms, radiometric dating, magnetostratigraphy, tephrochronology, and strontium isotope dating. On the basis of these data, we conclude that the Purisima Formation ranges in age from the latest Miocene (about 7 Ma) to the late Pliocene (about 2.6 Ma).

The Purisima Formation of Santa Cruz County, exposed in the sea cliffs from Santa Cruz to Rio del Mar, is here designated a supplementary reference section because it is the most complete and well studied Purisima section in central California.

Introduction

The Purisima Formation is widely distributed in central California from coastal exposures at Point Reyes in Marin County to more extensive exposures in the Santa Cruz Mountains from the coast in San Mateo and Santa Cruz

Counties inland to the San Andreas Fault (fig. 1). These scattered outcrops have been grouped as the Purisima Formation because they are all fine- to coarse-grained clastic rocks, with dark andesitic fragments and locally abundant silicic tephra, and occupy the same stratigraphic position at their various exposures. Since first described by Haehl and Arnold (1904), the Purisima Formation has been considered to be of Pliocene or of late Miocene to Pliocene age. Differing age assignments have resulted from the wide stratigraphic range of many commonly encountered megafossils and from the lack of agreement on the placement of the Miocene-Pliocene Series boundary between the provincial megafaunal chronology and that of international usage. Here, we use recent biostratigraphic, magnetostratigraphic, and age-dating techniques, together with the generally accepted placement of the Miocene-Pliocene

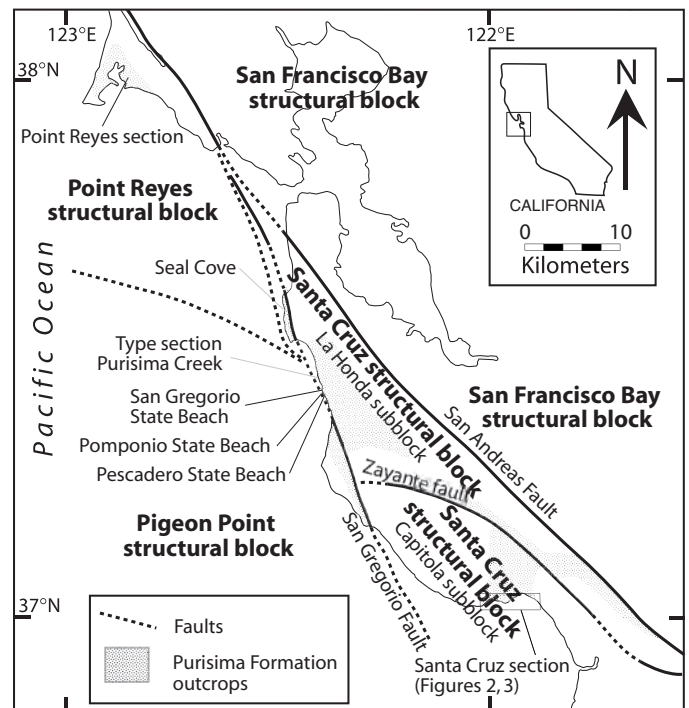

Figure 1. Map of the greater San Francisco Bay area, showing structural blocks, names, and boundaries as defined in the text. Gray shading also shows the outcrop area of the Purisima Formation.

¹ U.S. Geological Survey, Menlo Park, California

² Indiana University of Pennsylvania, Indiana, Pennsylvania

³ Santa Cruz City Museum, Santa Cruz, California

⁴ Rocklin, California

2 Age, Stratigraphy, and Correlation of the Late Neogene Purisima Formation, Central California Coast Ranges

boundary at 5.33 Ma (Ogg and Smith, 2004), to refine the age assignment and stratigraphic affinities of the Purisima Formation.

A major problem encountered while working in the Purisima Formation is that it occurs as scattered outcrops within fault-bounded blocks with significant strike-slip displacement (fig. 1). The Purisima Formation in each of these blocks commonly shows different lithologies from different depositional settings and can only be correlated with difficulty outside of its block. Even where thick stratigraphic sections of the Purisima Formation occur, they usually lack distinctive marker beds, making correlations outside of the fault-bounded blocks tentative at best. A review of the age of the Purisima Formation is thus complicated by its scattered occurrences with different lithologies from one fault-bounded block to another. Each block is discussed separately below.

The age of the Purisima Formation is important because (1) it places constraints on the timing of faulting and block deformation, as well as uplift of the Santa Cruz Mountains as reflected by the increase in clastic input in the Pliocene, and (2) the successions of its lithofacies, faunas, and floras can be compared with those of other late Tertiary basins from the Eel River south to Los Angeles.

In this report, we summarize published and new biostratigraphic and chronostratigraphic data for the Purisima Formation and designate the sea cliff section from Santa Cruz eastward to Rio del Mar, Santa Cruz County, as a supplementary reference section. This latter section of late Miocene to late Pliocene age is much thinner than the type section in the vicinity of Purisima Creek, San Mateo County, but its upper and lower contacts are exposed, and it represents the most continuously exposed and best dated Purisima section.

Previous Work

Purisima Formation was the name applied by Haehl and Arnold (1904) to “an extensive series of conglomerates, fine-grained sandstones and shales” that are exposed near the mouth of Purisima Creek. These workers believed that this formation was of early and perhaps middle Pliocene age based on its molluscan faunas.

The first geologic map showing the distribution of the Purisima Formation in the Santa Cruz Mountains was the Santa Cruz folio by Branner, Newsom, and Arnold (1909), who considered its age to range from late Miocene to Pliocene. Touring (1959) and Cummings, Touring, and Brabb (1962) believed the formation to be of Pliocene age and divided the Purisima in the type area of San Mateo County into five members—from oldest to youngest, the Tahana, Pomponio, San Gregorio, Lobitos, and Tunitas Members. The Tahana Member is as much as 650 m thick and consists of medium- to fine-grained sandstone and siltstone with silty mudstone present in some sections. It is overlain by the Pomponio Member, which consists of as much as 700 m of siliceous siltstone and

mudstone. This is overlain by the homogenous San Gregorio Member that is as much as 140 m thick and consists mostly of massive, fine- to coarse grained sandstone with irregularly distributed small pebbles of chert and basic volcanic rock. The San Gregonio Member is overlain by the Lobitos and Tunitas Members. The Lobitos Member is as much as 140 m thick and consists of massive, silty mudstone. The uppermost Tunitas Member consists of massive, fine-grained sandstone as much as 120 m thick. These members are only recognized in their type area in the La Honda subblock of the Santa Cruz block and are not present in other San Francisco Bay area blocks.

The earliest known published record on paleontological material from the West Coast of North America concerns “petrified bones of a cylindrical form” from sea cliff exposures [of the Purisima Formation] near Santa Cruz (Beechey, 1839; quoted in Merriam, 1921, p. 237). Kellogg (1927) and more recently Mitchell (1962) have described pinniped remains from the cliff exposures of the Purisima Formation near Point Santa Cruz. C.A. Repenning and J.C. Clark collected sirenian ribs and otarioid remains from the basal bed of the Purisima Formation west of Point Santa Cruz (U.S. Geological Survey Vertebrate locality M1109; figs. 2, 3). Barnes (1976) discussed cetaceans from throughout the formation. Repenning and Tedford (1977) reported vertebrate remains from the upper part of the formation at Santa Cruz that suggested a latest Hemphillian or Blancan mammalian age (latest early Pliocene to late Pliocene). Extensive collections of fishes and birds from the Santa Cruz section of the Purisima Formation are presently under study by Frank Perry.

The oldest report of fossil invertebrates from the Purisima Formation is that of Cooper (1888), who listed a few species from the Capitola area that he considered Pliocene. Ashley (1895) published a detailed invertebrate faunal list from what is now known as the Purisima Formation. He called this formation the “Merced Series” and considered it to be of very late Miocene and Pliocene age. Other reports of invertebrates from the Purisima Formation (sometimes referred to as Merced Series or Merced Formation) include Haehl and Arnold (1904); Arnold (1908); Branner, Newsom, and Arnold (1909); Martin (1916); Grant and Gale (1931); Glen (1959); Cummings, Touring, and Brabb (1962); Perry (1977); Addicott, Barron, and Miller (1978); Clark (1981); Wiley and Moore (1983); Norris (1986); Perry (1993); and Powell (1998). In addition, Arnold (1906) discussed the Purisima Formation and its fauna, but much of his discussion implies a biostratigraphic and not a lithostratigraphic unit.

Powell’s (1998) review of the literature and U.S. Geological Survey (USGS) megafossil collections from the Purisima Formation enabled him to define three molluscan faunas—from oldest to youngest, the La Honda, the Pillar Point, and the Santa Cruz. The oldest La Honda fauna suggested an age of late Miocene to early Pliocene, the Pillar Point fauna an age of Pliocene, and the Santa Cruz fauna a possible age range of early to late Pliocene. Durham and Morgan (1978) described two new echinoids from the Tahana Member in sea cliff exposures south of San Gregorio Beach and west of the San

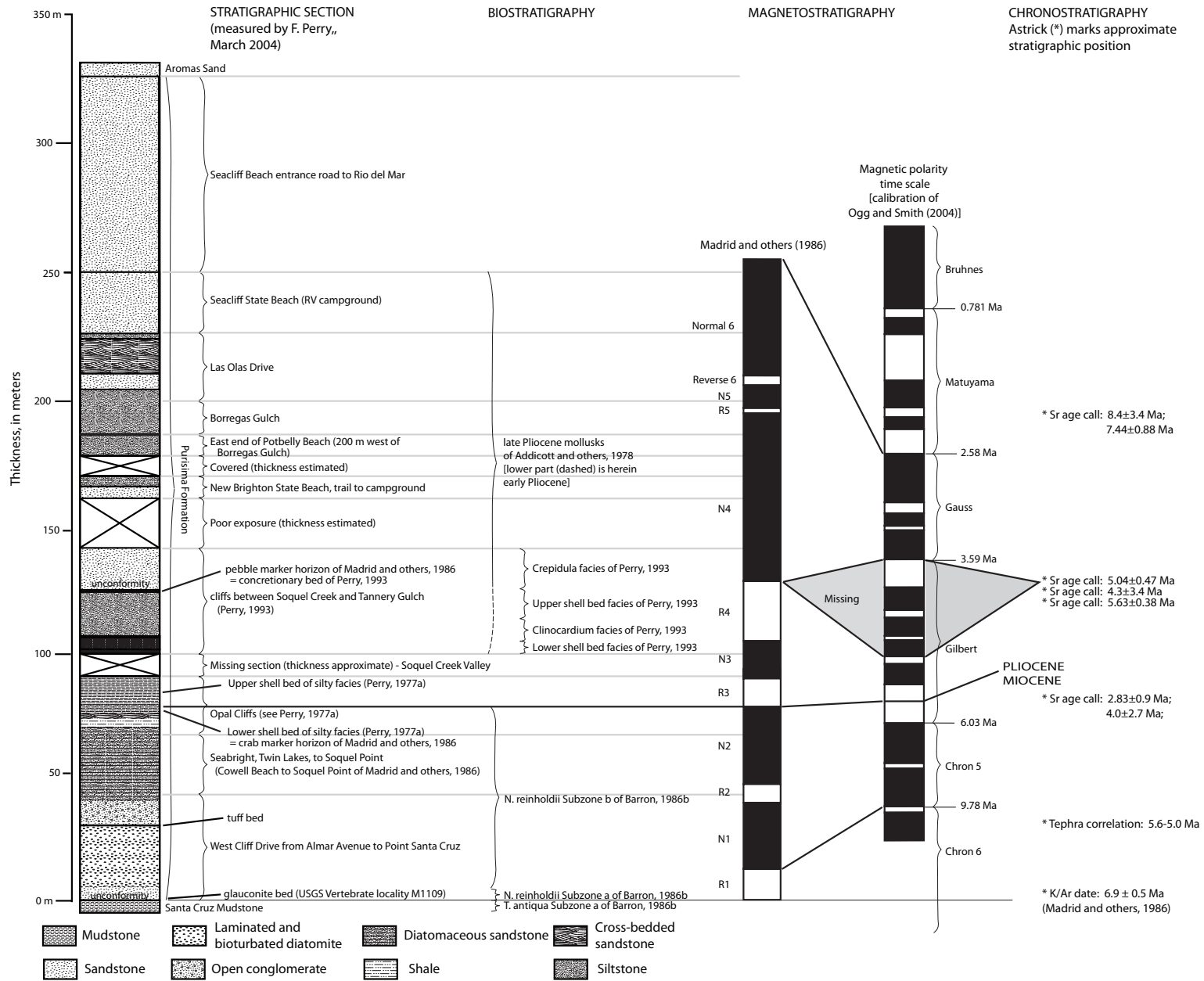

Figure 2. Supplementary reference section of the Purisima Formation along the coast between Point Santa Cruz and Rio del Mar, northern and eastern Monterey Bay, central California, showing lithostratigraphy, biostratigraphy, magnetostratigraphy, and chronostratigraphy (including tephrochronology and strontium isotope age determinations).

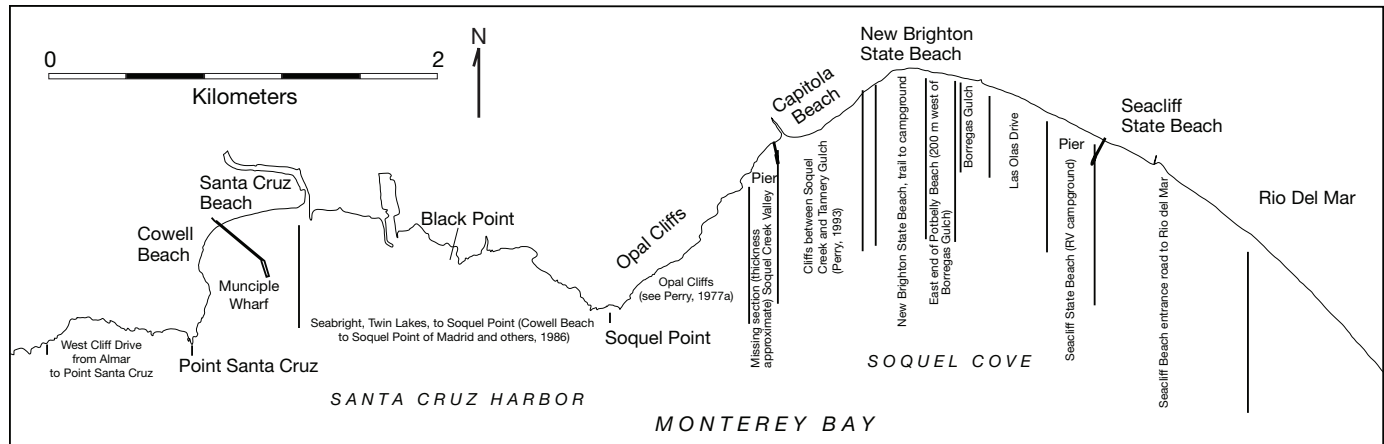

Figure 3. Map showing locations where various parts of the supplementary reference section of the Purisima Formation along the coast between Santa Cruz and Rio del Mar, north and central shore of Monterey Bay, central California, were measured. See figure 1 for location.

Gregorio Fault. They considered this member's age to be early Pliocene in terms of the "traditional West Coast megafaunal terminology" but recognized that it may be of late Miocene age in terms of the European type sections.

Through the mid-1900s most workers, utilizing the provincial California megafaunal chronology, considered the Purisima Formation to be of Pliocene age (Reinhart, 1943; Cummings, Touring, and Brabb, 1962; Clark, 1966). With the adoption of the European standard that placed the Miocene-Pliocene Series boundary at the top of evaporitic beds assigned to the Messinian Stage in southern Italy, dated at about 5 Ma (Berggren, 1972; Berggren and Van Couvering, 1974), the Purisima Formation again was assigned a late Miocene and Pliocene age by most workers (Barnes, 1976; Repenning and Tedford, 1977; Clark, 1981; Gavigan, 1984; Perry, 1993; Powell, 1998).

Benthic foraminifers are locally abundant in sea cliff exposures of the Purisima Formation in San Mateo County and have been reported by Goodwin and Thomson (1954); Touring (1959); Cummings, Touring, and Brabb (1962); and from dredged samples in northern Monterey Bay by Greene (1977). Goodwin and Thomson (1954) suggested that their foraminiferal assemblage from the "middle Purisima" was the age equivalent of the Sisquoc Formation of the Santa Maria Basin, which is now considered to be late Miocene to early Pliocene on the basis of diatoms (Dumont and Barron, 1995).

Hard number dating of the Purisima Formation has given a variety of results from different exposures of the formation. Radiometric dating of the Santa Cruz section (Clark, 1966; Gavigan, 1984; Madrid, Stuart, and Verosub, 1986) give dates between 6.9 ± 0.5 Ma and 5.2 ± 1.2 Ma. However, magnetic polarity zonation together with the first and last occurrences of stratigraphically diagnostic diatoms suggested an age of about 6.07 Ma to 2.47 Ma, with a hiatus from 4.5 to 3.5 Ma (Madrid, Stuart, and Verosub, 1986). These data will be discussed in detail below.

Geologic Framework

Structural Blocks

The concept of dividing the San Francisco Bay region into fault blocks with unique geologic histories goes back as far as Clark (1930), who believed that the blocks moved up and down relative to each other during the Cenozoic Era. A classic report by Hill and Dibblee (1953) opened the possibility that some of the blocks may have moved hundreds of kiloms laterally with respect to each other. In the following, we describe the Purisima Formation in the Santa Cruz, Pigeon Point, and Point Reyes blocks and possible correlatives in the San Francisco Bay block, as these blocks are defined below.

Santa Cruz Block

This tectonic block is part of the elongate Salinian terrane that in the Santa Cruz Mountains is bounded by the San Andreas and Pilarcitos Faults to the northeast and by the San Gregorio Fault to the southwest (fig. 1). During Paleogene time, this block was subdivided by the Zayante Fault into the La Honda subblock to the north and the Capitola subblock to the south. Dip-slip displacement on the Zayante Fault greatly influenced the Oligocene stratigraphy of the area. This fault ceased to be an important structure by Neogene time (Clark and Reitman, 1973) and did not affect deposition of the Purisima Formation that was laid down across this fault in the central and southern Santa Cruz Mountains (fig. 1).

Regional Stratigraphy

Southwest of the San Andreas Fault and northeast of the San Gregorio Fault in the Santa Cruz Mountains is one of

the most complete Tertiary sections in the California Coast Ranges. The exposed basement consists largely of Cretaceous granitic rocks with older included metasedimentary rocks of the Salinian terrane and of unexposed magnetic rocks interpreted to be Jurassic gabbro (McLaughlin and others, 2001). Overlying these basement rocks is a succession composed mostly of sandstone and mudstone and locally, volcanic rocks, ranging in age from Paleocene to Pliocene, having a composite thickness of as much as 7,390 m. This Tertiary section is divisible into four sedimentary rock sequences that are essentially continuous, each of which is bounded by unconformities of regional extent (Clark, 1981).

The oldest sedimentary sequence, resting locally on Salinian basement rocks, consists of erosional remnants of the Locatelli Formation of late Paleocene (Ynezian benthic foraminiferal zone [bfz]) age. Megafossiliferous shelfal sandstone beds grade upward into bathyal to abyssal siltstone and mudstone beds.

The next younger sequence ranges from early Eocene (Penutian bfz) to early Miocene (Saucesian bfz) age and consists of the Butano Sandstone, San Lorenzo Formation, Mindego Basalt, Zayante Sandstone, Vaqueros Sandstone, and Lambert Shale. Bathyal deposition was followed by local shallowing during Oligocene (Zemorrian bfz) time.

The two youngest sequences are the products of two separate and successive marine cycles of sedimentation. The older cycle was an early to middle Miocene (Relizian and Luisian bfz) event that produced a widely transgressive, basal sandstone unit, the Lompico Sandstone, and an overlying organic mudstone unit, the Monterey Formation. The younger cycle was initiated in late Miocene (Mohnian bfz) time and likewise produced a transgressive, basal sandstone unit, the Santa Margarita Sandstone, and an overlying siliceous mudstone unit, the Santa Cruz Mudstone. The basal sandstone beds of each of these two sequences were deposited in nearshore, shallow-marine environments, whereas the overlying mudstone beds were laid down in deeper water, probably at neritic to bathyal depths. Deposition during the late Miocene to Pliocene sequence was interrupted by uplift and erosion in the vicinity of Santa Cruz that produced an angular unconformity at the base of the Purisima Formation. The Purisima Formation, of late Miocene to late Pliocene age, records a widespread marine transgression that was followed by deposition of continental beds of fluvial and eolian origin that include the Aromas Sand of Pleistocene and likely Pliocene age.

Purisima Formation Members

The type sections for the Purisima Formation members were established by Cummings, Touring, and Brabb (1962), based entirely on the thesis of Touring (1959)—from oldest to youngest, the Tahana, Pomponio, San Gregorio, Lobitos, and Tunitas Members. The type sections for the San Gregorio, Lobitos, and Tunitas Members are exposed in sea cliffs between Purisima and Lobitos Creeks in the Half Moon Bay

7.5' quadrangle, and most of the members cannot be recognized outside of their type area.

The type section of the oldest member, the Tahana Member, is in section 36, T. 7 S., R. 5 W., La Honda 7.5' quadrangle, where it rests unconformably on the Santa Cruz Mudstone and underlies the Pomponio Member. No stratigraphic column was provided by Cummings, Touring, and Brabb (1962) because the Tahana is poorly exposed. Two supplementary reference sections were provided, one of them along McCormick Creek, section 34, T. 7 S., R. 4 W., La Honda 7.5' quadrangle, and the other along the sea cliffs between Pomponio and Pescadero Creeks, west of the San Gregorio Fault in the San Gregorio 7.5' quadrangle (Touring, 1959) and in the Pigeon Point structural block.

The section for the Tahana Member along McCormick Creek could have been extended upward on the hills west of McCormick Creek where the Pomponio Member is exposed. Within the area bounded by the Pilarcitos and San Gregorio Faults, Cummings, Touring, and Brabb (1962, plate 20) show the Tahana Member of the Purisima Formation as resting unconformably on rocks as old as Eocene and as young as late Miocene.

The type section for the Pomponio Member is “typically exposed on both sides of Pomponio Creek for about 2 miles east of the San Gregorio Fault. The thickness of this member in the type section is approximately 2,300 feet” (700 m) (Cummings, Touring, and Brabb, 1962, p. 202). This description is for an area, not a section, and no stratigraphic column was provided. A stratigraphic column is provided (Cummings, Touring, and Brabb, 1962, plate 22) for the Purisima Creek area 8 miles north of Pomponio Creek, but that area is folded and faulted so that stratigraphic relations there are uncertain. “A supplementary but less complete section is fairly well exposed on the south side of a hill (elevation 830 feet [250 m]) in the E 1/2 section 22, T. 7 S., R. 5 W.” (Cummings, Touring, and Brabb, 1962, p. 202) at the eastern edge of the San Gregorio 7.5' quadrangle.

Age

Mudstone in the lower part of the type section of the Tahana Member along Pescadero and McCormick Creeks in the La Honda 7.5' quadrangle (Cummings, Touring, and Brabb, 1962, plate 22) contains the diatoms *Nitzschia miocenica* and *Thalassiosira miocenica* (appendix 1), making it correlative with the middle part of Subzone b of the *N. reinholdii* Zone or about 6.4 to 6.2 Ma. These floras were collected near the base of the member to as high as about 800 feet (240 m) above the base. Much of the section above the sample at 800 feet is covered or poorly exposed. However, we recovered a few samples correlative with the lowermost part of *Thalassiosira oestrupii* Zone (about 5.5 to 5.3 Ma; latest Miocene) from the uppermost part of the Tahana Member, about 1,600 feet (490 m) above the base, which suggests that the boundary between the type Tahana Member and the overlying Pomponio Member may approximate the Miocene-Pliocene boundary (fig. 4).

An ash was collected from the general area of the type Tahana Member in the La Honda subblock—a ~40-cm-thick bed of light-gray, relatively pure tuff exposed in a road cut along San Gregorio Road, opposite entrance to property at 5874 San Gregorio Road, and east of the San Gregorio Fault. This ash yields an estimated age for the Tahana between 6.0 and 6.7 Ma based on its correlation with an ash from the Ventura Basin, southern California dated with diatoms (see later discussion under Chronostratigraphic Ages).

The rest of the Purisima Formation, including nearly all of the Pomponio Member, has few diatoms, and nearly all of these are poorly preserved and not age diagnostic. One sample (00CB5104) from the Pomponio Member near the mouth of Purisima Creek (Half Moon Bay 7.5' quadrangle) contains a flora suggestive of the early Pliocene (5.3 to 3.7 Ma), but definitive taxa are missing.

Depositional Environment of the Type Purisima Formation Members

One of the most common Tahana Member mollusks in the La Honda subblock is the bivalve *Acila castrensis* (Hinds), which lives today at inner sublittoral (classification of marine environments by depth and wave exposure follows Valentine, 1961, p. 328) to possibly bathyal water depths (5-400 m; Coan, Scott, and Bernard, 2000), although most of the fauna indicate shallower, inner sublittoral to shallow outer sublittoral depths (9-90 m). Similarly, in the lower Pomponio Member the *Elphidiella hannai* Zone foraminiferal fauna of Goodwin and Thompson (1954) indicates inner neritic depths (0-50 m), whereas the rhythmically bedded mudstone beds of the upper Pomponio Member contain rare bivalve *Lucinoma annulata* (Reeve) of adlittoral to bathyal depths (25-750 m) (Coan, Scott, and Bernard, 2000). Although Goodwin and Thomson (1954) interpreted their *Uvigerina juncea* Zone fauna from this upper Pomponio section as suggestive of neritic depths (0-200 m), the benthic foraminifers are more diagnostic of upper middle bathyal (1,500-500 m) to upper bathyal (500-150 m) depths (Bandy, 1955; R.S. Boettcher, written commun., 1966).

Shallowing occurred during deposition of the San Gregorio Member, as the upper part of this member yields littoral to shallow outer sublittoral restricted mollusks such as *Clinocardium nuttallii* (Conrad), *Cryptomya*, *Olivella*, and *Siliqua*, indicating depths less than 100 m. All taxa present are consistent with normal marine salinities. Mollusks are much rarer in the Lobitos and Tunitas Members, but the extant species *Periploma discus* Stearns from both members indicates normal marine salinities and water depths less than 50 m (Coan, Scott, and Bernard, 2000).

These depth interpretations for the type section are in remarkable agreement with the sea level curves of Haq, Hardenbol, and Vail (1987), which indicate that the highest sea level stand during late Miocene to Pliocene time approximately coincided with deposition of the Pomponio Member (fig. 4).

Supplementary Reference Section

Exposures along the north shore of Monterey Bay constitute the Santa Cruz section of the Purisima Formation, herein designated a supplementary reference section. This section is approximately 325 m thick and crops out along a 19-km stretch of shoreline from the city of Santa Cruz eastward to Rio del Mar in Santa Cruz County (figs. 2, 3).

The composite stratigraphic column (fig. 2) shows the lithostratigraphy, biostratigraphy, magnetostratigraphy, and chronostratigraphy for the Santa Cruz section of the Purisima Formation. The thicknesses and descriptions of the rock units are based partly on those of Madrid, Stuart, and Verosub (1986) and Norris (1986) with extensive revision by the authors. Thickness measurements for some units are approximate because of poor exposure, faulting, and lack of distinct beds for correlation. Bedding, where present, dips gently (0 to 5 degrees), mostly to the southeast.

An angular unconformity at the base of the Purisima Formation separating it from the underlying Santa Cruz Mudstone is exposed below West Cliff Drive in the city of Santa Cruz. Here, a bed of glauconitic sandstone about 0.5 m thick is present in the basal Purisima Formation. The glauconitic sandstone grades upward into 25 to 35 m of laminated and bioturbated diatomite (Madrid, Stuart, and Verosub, 1986), which, in turn, is overlain by 35 to 45 m of a massive (bioturbated) fine- to medium-grained sandstone unit with large spheroidal concretions in the lower part and mollusks near the top. The sandstone unit is capped by 1 to 2 m of sandstone that is cross-stratified and convolute bedded, which in turn is overlain by as much as 15 m of siltstone containing two thin shell beds. The lower of these shell beds is the "crab marker horizon" of Madrid, Stuart, and Verosub (1986).

The next 150 m of the Purisima Formation consists of alternating units of mudstone; bioturbated sandstone; interbedded sandstone, mudstone, and shells; and, near the top of this section, amalgamated sandstone and coquina. An important marker bed within this section is the "concretionary bed" of Perry (1993), named the "pebbly marker horizon" by Madrid, Stuart, and Verosub (1986).

The upper 75 m is not well exposed but is composed of sand and gravel with common cross bedding. We locate the contact between the Purisima and the overlying Aromas Sand 2.6 km east of the mouth of Aptos Creek, as indicated by Brabb (1989). Madrid, Stuart, and Verosub (1986) placed the contact at the uppermost occurrence of shell fossils at Seaciff State Beach. This is roughly 75 m lower stratigraphically than Brabb's (1989) contact. It must be emphasized that the thickness of this upper part of the section is only approximate because of poor exposure.

The Santa Cruz section of the Purisima records an overall shallowing of marine conditions during the late Miocene and Pliocene, punctuated by a series of transgressive-regressive events. The diatomite near the base of the formation was probably deposited on the outermost shelf or slope. Much of the rest of the section alternates between the middle and inner

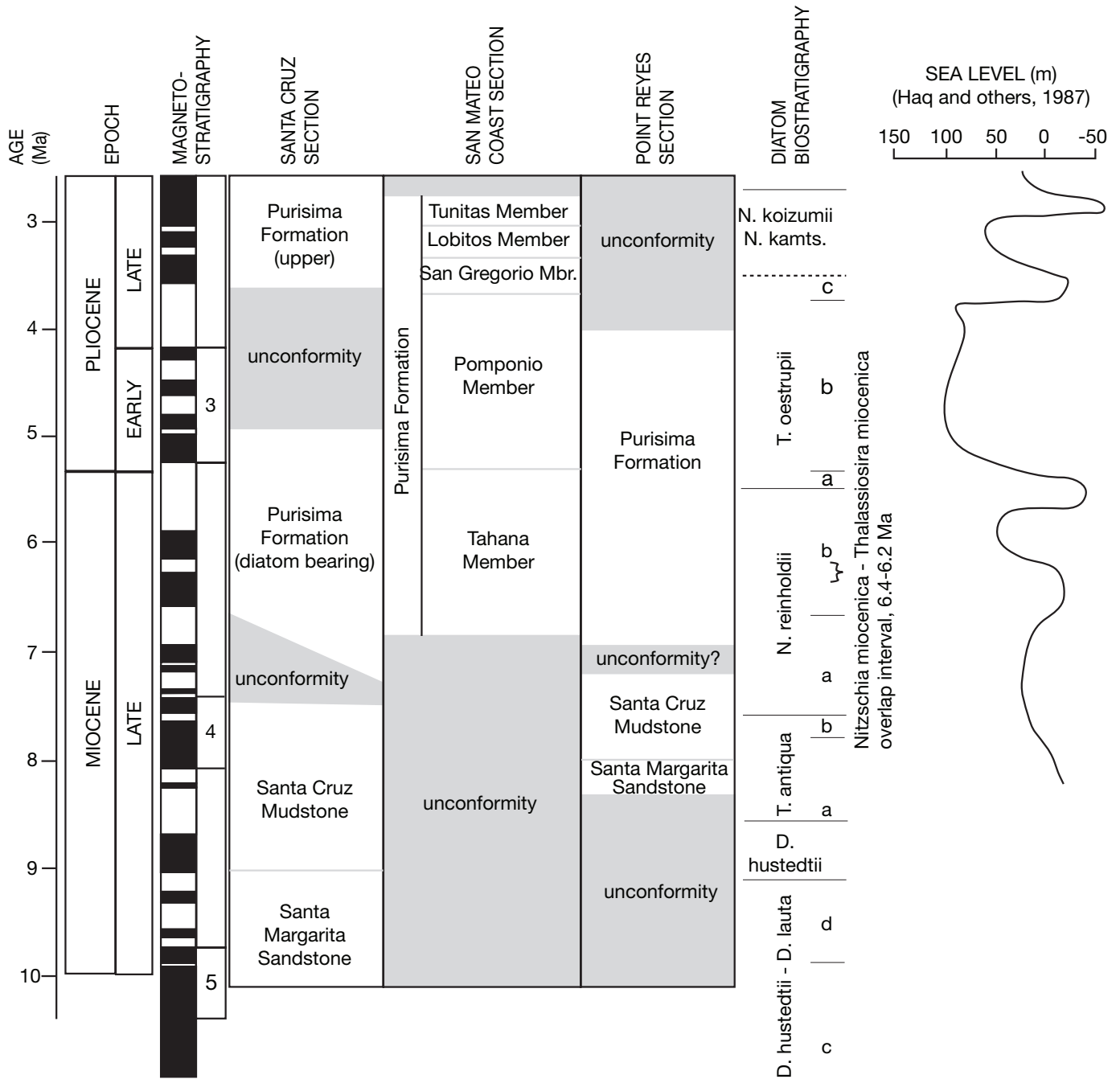

Figure 4. Correlation of stratigraphic sections at Santa Cruz, San Mateo County coast (Santa Cruz structural block), and Point Reyes (Point Reyes structural block) with the diatom biostratigraphy of Barron (1986b; ages updated by Barron and Isaacs, 2001), the Haq, Hardenbol, and Vail (1987) sea level curve, and the paleomagnetic timescale of Cande and Kent (1995). The uppermost part of the Santa Cruz Mudstone, where it unconformably underlies the Purisima Formation along West Cliff Drive in Santa Cruz, contains diatoms assignable to Subzone a of the *Thalassiosira antiqua* Zone (8.7-7.8 Ma) (J.A. Barron, unpub. data, 1980). West of Bolinas (Point Reyes Section), the uppermost Santa Cruz Mudstone contains diatoms assignable to Subzone a of the *Nitzschia reinholdii* Zone (7.6-6.7 Ma) (J.A. Barron, unpub. data, 1985). In the magnetic stratigraphy column black represents normal polarity, white represents reverse polarity.

shelf depositional environments based on fossils and sedimentary structures. The upper part of the formation records foreshore, shoreface, and possible nonmarine deposition, again based on fossils, or their absence, and sedimentary structures (Norris, 1986; Perry, 1993).

Age

The lower part of this Purisima Formation reference section contains well preserved diatoms that can be correlated with the standard North Pacific diatom zones. Diatom biostratigraphy suggests that the lower part of the Purisima ranges in age from the late late Miocene to the earliest Pliocene, or about 7 to 5 Ma (ages of diatom biostratigraphy updated by Barron and Isaacs, 2001). Diatoms assignable to both the a and b Subzones of the *Nitzschia reinholdii* Zone and the overlying *Thalassiosira oestrupii* Zone have been documented in Purisima Formation exposures along the sea cliffs in Santa Cruz and in various isolated sections in the Santa Cruz Mountains (Addicott and others, 1978; Barron *in* Clark, 1981; Barron, 1986b; Dumont, Baldauf, and Barron, 1986; appendix A). Typically, rocks in the middle and upper parts of the Purisima Formation cannot be dated by diatoms, as they are very much enriched in clastic debris, and the sparse diatoms present are mechanically abraded and poorly preserved.

Madrid, Stuart, and Verosub (1986) performed a detailed, magnetic polarity zonation analysis that together with the first and last occurrences of stratigraphically diagnostic diatoms suggested an age of about 6.07 to 2.47 Ma, with a hiatus from 4.5 to 3.5 Ma, in the Santa Cruz section of the Purisima Formation. On the basis of this, Dumont and Madrid (1987) later suggested that this Santa Cruz section of the Purisima spans the interval from the Chron 5/Chron 6 boundary at 6.57 Ma (Cande and Kent, 1995) to the Matuyama/Gauss boundary at 2.58 Ma (Cande and Kent, 1995) with a significant hiatus corresponding to the Gilbert Chron (4.9 to 3.65 Ma; Cande and Kent, 1995).

The first reported radiometric date from the Purisima Formation is from glauconite collected from the base of the Santa Cruz section (USGS locality M1109; fig. 2) that was dated at 6.7±0.5 Ma (Clark, 1966), adjusted in accordance with the more recent K-Ar constants of Dalrymple (1979) to 6.9±0.5 Ma (Madrid, Stuart, and Verosub, 1986).

Two ashes were recovered from this section, or nearby. They include one from along Bridge Creek, northeast of Santa Cruz, in the Laurel 7.5' quadrangle (N37° 02.00', W 121° 54.10'; fig. 5); and one from cliffs along West Cliff Drive, just west of Point Santa Cruz in the city of Santa Cruz, Santa Cruz 5' x 11' quadrangle (Madrid, Stuart, and Verosub, 1986; figs. 2 and 5).

The composition of the tephra layer from Bridge Creek (sample 76CB1624; fig. 5) matches best with several samples of tephra that are believed to be precursors, or the preliminary plinian eruptions, of the Nomlaki Tuff (Member of the Tehama and Tuscan Formations), dated at >3.3 Ma (Evernden and others, 1964; Sarna-Wojcicki, 1976; fig. 5). Thus, this unit is

probably older than 3.3 Ma, but exactly how much older is not known. It is apparently younger than the unit from cliffs along West Cliff Drive described below.

The composition of the tephra layer in the Purisima Formation from cliffs along West Cliff Drive, just west of Point Santa Cruz, in the city of Santa Cruz (sample WC-3; Madrid, Stuart, and Verosub, 1986) matches best with a tephra layer (upper of two) in the uppermost part of the Pancho Rico Formation, near Topo Valley in the Gabilan Range in San Benito County (Dohrnwend, 1975). There, the correlative tephra layer (samples JCD-3 and JCD-3A) is underlain by another tephra layer (JCD-5, 5A) that correlates to tephra layers dated in the range of 5.0 to 5.6 Ma (or ~5.3 ±0.3 Ma; appendix 3). One of the latter is the Den Hartog tuff of Loomis (1992) from the Etchegoin Formation in the Kreyenhagen Hills west of the Kettleman Hills in Fresno County, farther southeast of Topo Valley, and dated by her as 5.0 ±0.3 Ma. Samples JCD-5 and -5A also match with the freshwater ash present in the Wildcat Group in the Eel River basin of northwestern California. Volcanic glass from the latter unit has been dated as 5.2 and 5.6 Ma by the K-Ar method (Wagner, 1980), although vesiculated or fine-grained volcanic glasses tend to yield unreliable K-Ar and Ar-Ar ages. The Pancho Rico Formation is overlain in the Topo Valley area by the Paso Robles Formation, and the latter contains a tephra layer (sample JCD-1) near its base that correlates with a tephra layer in the Huichica Formation of northern California, dated as 4.71 ±0.03 Ma (H-1, and other samples; appendix 3; McLaughlin and others, 2005). Thus, by these correlations, the upper tephra layer in the Pancho Rico Formation is bracketed by dates of ~4.7 and ~5.3 Ma. Consequently, the correlative tephra in the cliffs along West Cliff Drive at Santa Cruz is estimated to be between about 4.7 and 5.3 Ma, or ~5.0 ±0.3 Ma (see figs. 2 and 5).

Southeast Santa Cruz County

The Purisima Formation in the southeastern part of Santa Cruz County west of the San Andreas Fault and east of the Zayante Fault rests unconformably on hornblende-quartz gabbro of Jurassic age, on the Butano Sandstone of Eocene age, and on rocks as young as the Lambert Shale of early Miocene age. It is overlain by nonmarine strata that are likely equivalent to the Paso Robles Formation of late Pliocene and Pleistocene age. The Purisima Formation has mostly a southwest dip in much of this area, but it forms the flanks of the Glenwood Syncline and other small folds in the The Forest of Nisene Marks State Park area, and probably elsewhere. Poor exposures make delineation of structures and measurement of a stratigraphic column difficult.

The thickness of the Purisima Formation along Corralitos Creek from north of Clipper Gulch, where the formation rests unconformably on the Vaqueros Sandstone of late Miocene age (Dibblee and Brabb, 1980), to the Mormon Gulch area at the axis of the Glenwood Syncline is about 1,060 m (3,500 ft). The formation in that area is mostly massive sandstone that forms majestic cliffs along the road through Corralitos Canyon.

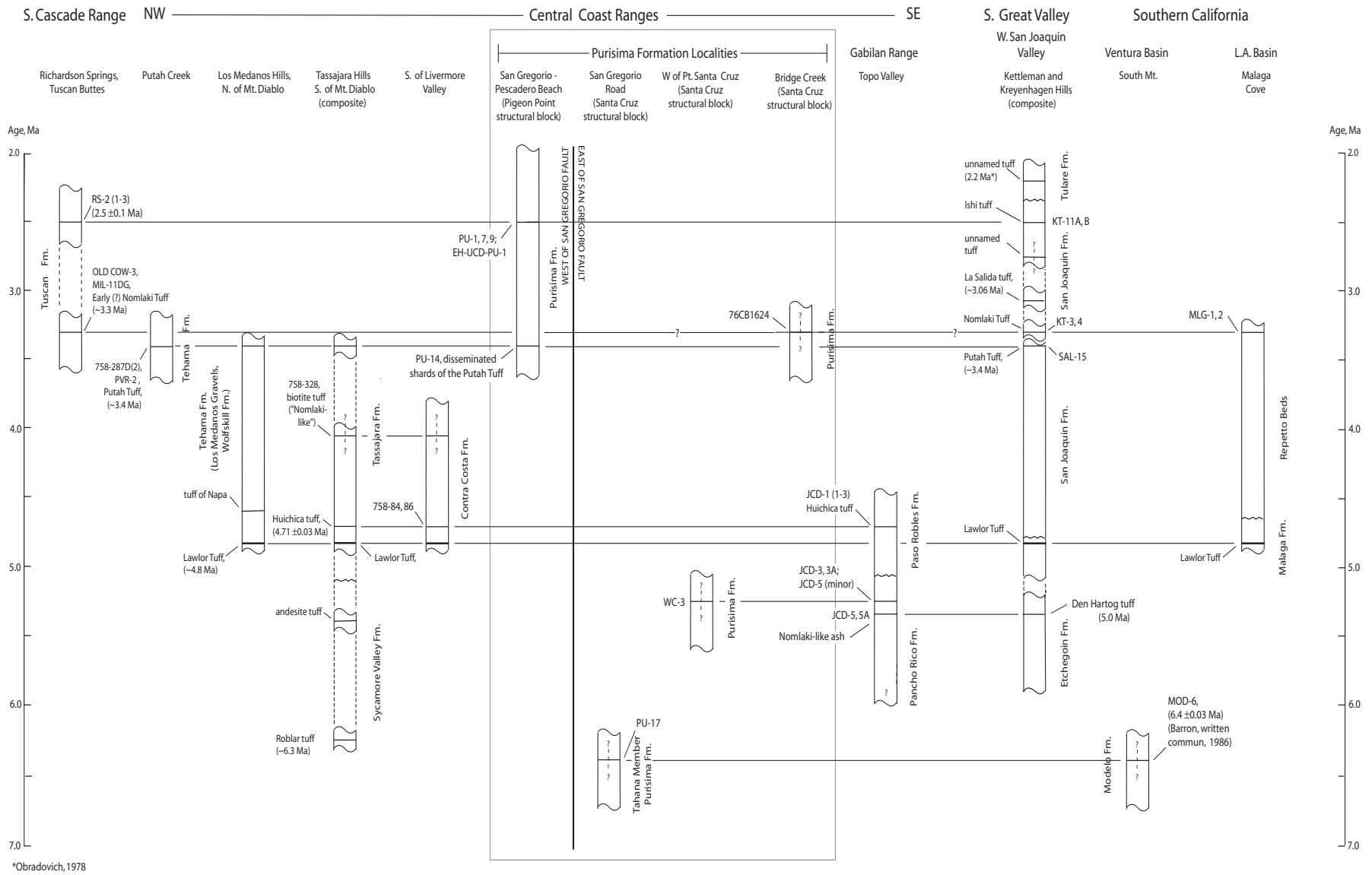

*Obradovich, 1978

Figure 5. Chronostratigraphy of tephra found in the Purisima Formation, central California, based on tephra correlations in the Western United States. Field numbers and correlations are based on published database compiled by A.M. Sarna-Wojcicki, U.S. Geological Survey, 2005.

The Purisima Formation in the Chittenden Pass area west of the San Andreas Fault was mapped by Dibblee and Brabb (1978), whose map and field notes and a report by Allen (1946) form the basis for this description. The basal part of the 500-m-thick formation in that area consists mainly of glauconitic sandstone and conglomerate with gabbro boulders and lesser amounts of Franciscan Complex sandstone boulders, shale, granite, rhyolite, chert, and common fragments of barnacles and mollusks. The middle and upper part of the Purisima, sandstone and siltstone, has oyster beds, one of which is more than 11 m thick, and common mollusks. A 60-cm (2-ft) thick diatomite bed (locality Mf 2998; 75CB1421) in what seems to be the faulted lower part of the formation is correlated by John Barron with Subzone b of the *Nitzschia reinholdii* Zone of late Miocene age.

A large molluscan fauna of more than 60 taxa attributed to the San Pablo, Santa Margarita, Purisima, Etchegoin, and Merced Formations has been reported in the Chittenden Pass area by Jones (1911), Martin (1916), and Allen (1945). Faunas attributed to these formations show no age difference in Chittenden Pass and were all attributed to the Purisima Formation of Allen (1945) by Powell (1998), and several species reported by these authors indicate a late Miocene to early Pliocene (“Jacalitos”/“Etchegoin” CPMS) age. Most of the fossil localities in the Chittenden Pass area appear to be east of the San Andreas Fault Zone and these rocks have been referred to the Etchegoin Formation (Dibblee and Brabb, 1978). We prefer using either unnamed Pliocene rocks or Pancho Rico Formation *sensu lato* in this area because (1) although disconnected from outcrops of the Pancho Rico Formation (Durham and Addicott, 1965) this area was an outlet to the Pacific Ocean for marine water in which, at least, the early Pliocene part of the Pancho Rico Formation was deposited (Galehouse, 1967), (2) lithologically these rocks are similar to both the Pancho Rico Formation and Etchegoin Formations, but they lack the blue color of the Etchegoin Formation and therefore appear more similar to the Pancho Rico Formation in color.

Seal Cove Section

The Seal Cove strand of the San Gregorio Fault separates two different facies of the Purisima Formation. East of this strand at Fitzgerald Marine Reserve (fig. 6), the Purisima Formation overlies the Cretaceous Montara granodiorite of Darrow (1963) and consists of as much as 75 m of sandstone and conglomerate that were deposited in a marine environment at shelfal water depths (Wiley, 1983). North of Pilar Point and west of the Seal Cove strand of the San Gregorio Fault, rocks attributed to the Pomponio Member (Touring, 1959) crop out in the intertidal zone. We interpret this Purisima section as an offset sliver of the Santa Cruz block within the San Gregorio Fault Zone. Although these beds were mapped as “Merced” by Branner, Newsom, and Arnold (1909), Glen (1959) correctly assigned them to the Purisima Formation and suggested that they were deposited at upper bathyal depths.

Four molluscan taxa, *Lucinoma annulata* (Reeve), *Panope?* sp., *Lituyapecten purisimaensis* (Arnold), and *Conchocele disjuncta* Gabb, have been reported from this area (Glen, 1959). The cooccurrence of *Lucinoma annulata* (Reeve) and *Conchocele disjuncta* Gabb indicates water depths of 100 m to 750 m (Bernard, 1983). These bivalves represent the Pillar Point fauna of Powell (1998) and are not age diagnostic, but are thought to lie stratigraphically between the La Honda and Santa Cruz faunas of Powell (1998) based on the known stratigraphic range of extinct taxa elsewhere in California. They were separated from the other Purisima Formation faunas because they represent a deeper water environment than indicated by the other faunas. Foraminiferal analysis discussed earlier in this report supports Glen’s upper bathyal interpretation, and the joint occurrence of the foraminifers *Buccella frigida* (Cushman), *Fursenkoina californiciensis* (Cushman), *Nonionella miocenica* Cushman, and *Uvigerina peregrina* Cushman is diagnostic of an early Pliocene age for these mudstone beds (Kristin McDougall, written commun., 2002).

Pigeon Point Block

In the central Santa Cruz Mountains, the Pigeon Point block is separated from the Santa Cruz block to the northeast by the San Gregorio Fault (fig. 1). The Pigeon Point block is bounded to the north by an offshore structural discontinuity that is interpreted by Dickinson and others (2005) to be the offset Nacimiento Fault, separating Salinian granitic basement of the Farallon Ridge to the north from the Franciscan and ophiolitic basement of the Pigeon Point block to the south (McLaughlin and Clark, 2004).

The San Gregorio Fault Zone of the offshore San Gregorio-Hosgri Fault Zone comes onshore east of Point Año Nuevo. The Purisima Formation is extensively exposed west of this fault from the Año Nuevo area northward to San Gregorio Beach in the Pigeon Point block (fig. 1).

Stratigraphy

Southwest of the San Gregorio Fault, sedimentary strata of Mesozoic and Cenozoic age overlie probable Franciscan Complex and ophiolitic basement (McLaughlin and Clark, 2004; Dickinson and others, 2005). The Mesozoic section consists of more than 2,600 m (8,500 ft) of marine clastic sedimentary rocks, the Pigeon Point Formation of Late Cretaceous age. This formation crops out along the coast and has been penetrated by wells in the Año Nuevo 7.5’ quadrangle. Unconformable upon, and locally faulted against the Pigeon Point Formation are approximately 1,200 m (3,900 ft) of clastic sedimentary and volcanic rocks that range in age from Oligocene (Zemorrian) to Holocene. The Cenozoic section includes the Vaqueros(?), Monterey, and Purisima Formations, which are complexly folded and faulted in exposures north and east of Point Año Nuevo.



Figure 6. Photograph of part of Fitzgerald Marine Reserve near Moss Beach on the San Mateo County coast, showing exposures of the Purisima Formation that are folded into a northwest plunging syncline beautifully exposed in the intertidal zone. This section of the Purisima Formation is located east of the Seal Cove segment of the San Gregorio Fault and consists of thin beds of highly indurated, calcareous cemented, medium- to fine-grained, gray sandstone interbedded with abundantly fossiliferous, pebbly conglomerate and several moderately thick, angular pebble beds that lack fossils, correlated with Pliocene outcrops at Año Nuevo State Reserve and the beach section at Santa Cruz. Some fossils from these beds have been transported downslope and may represent periodic deposition in deeper water than where they lived. (U.S. Geological Survey photography by A.M. Sarna-Wojcicki).

Año Nuevo Section

East of Point Año Nuevo the San Gregorio Fault Zone is as wide as 3 km and includes at least five northwest-trending faults (fig. 7). There, three sections of the Purisima are juxtaposed by these faults, and their stratigraphic interrelationships are uncertain (Clark, 1981, plate 1; Powell, 1998, fig. 8). A western mudstone section (unit Tpm of Clark, 1981) rests unconformably on the siliceous Monterey Formation and is about 76 m thick. A diatom flora from about 15 m above the base of this section is diagnostic of Subzone b of the *Thalassiosira oestrupii* Zone of latest Miocene to early Pliocene age (locality Mf 3856; appendix 1).

Farther east, two faunally distinct Purisima Formation sandstone sections (unit Tps of Clark, 1981) are separated by the Frijoles strand of the San Gregorio Fault. The molluscan fauna from the section west of this fault was believed by Branner, Newsom, and Arnold (1909) to be similar to that of the type Purisima Formation to the north. In the subsurface, this section rests on the Cretaceous Pigeon Point Formation, which was penetrated in the Richfield Steele core hole (Clark, 1981,

p. 36, pl. 1). The eastern sandstone section is truncated to the east by the main strand of the San Gregorio Fault (the Coastways Fault of Weber, 1990) and contains an abundant molluscan assemblage that is almost identical to that of the middle part of Purisima Formation in the Santa Cruz section about 40 km to the southeast and east of the San Gregorio Fault (Clark, Brabb, and Addicott, 1979). Because Branner, Newsom, and Arnold (1909) believed that this fauna was younger than that of the typical Purisima and similar to that of the lower part of the type Merced northeast of the San Andreas Fault, they incorrectly mapped these beds east of the Frijoles strand of the San Gregorio Fault as “Merced” (Clark and others, 1984).

San Gregorio Beach Section

The largest area of Purisima Formation, assigned to the Tahana Member by Cummings and others (1962), crops out in a broad band west of the San Gregorio Fault from coastal exposures near San Gregorio Creek southward to Franklin Point, where it rests unconformably on the Cretaceous Pigeon Point Formation. This section of the Purisima Formation is

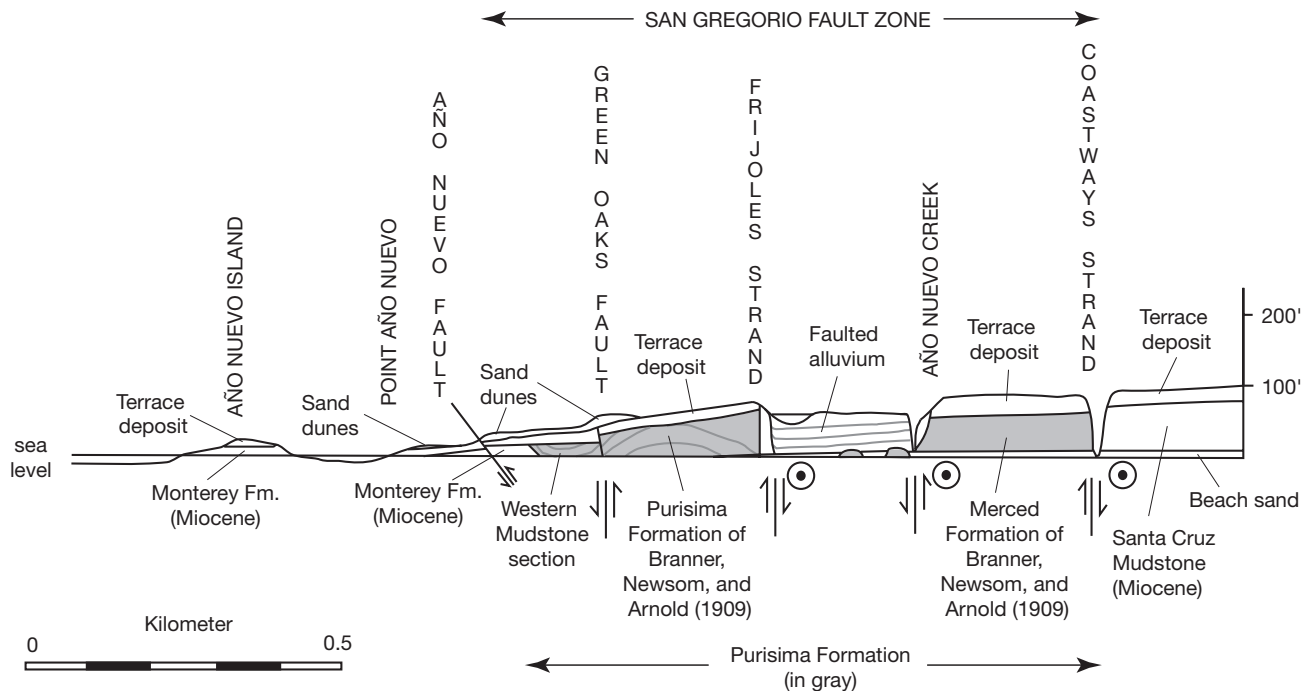

Figure 7. Generalized sea-cliff geology on south side of Point Año Nuevo, San Mateo County. Three sections of the Purisima are juxtaposed by faults within the San Gregorio Fault Zone. A western mudstone section rests unconformably on the siliceous Monterey Formation. To the east, two faunally distinct Purisima Formation sandstone sections are separated by the Frijoles strand of the San Gregorio Fault. The molluscan fauna from the section west of this fault was believed by Branner, Newsom, and Arnold (1909) to be similar to that of the type Purisima Formation to the north. The eastern sandstone contains an abundant molluscan assemblage that is almost identical to that of the middle part of Purisima Formation in the Santa Cruz section. Outcrops of the Purisima Formation between the Frijoles strand of the San Gregorio Fault Zone and Año Nuevo Creek are only intermittently exposed along the beach in the sea cliffs when sand levels are low. They are lithologically similar to the Purisima Formation of Branner, Newsome, and Arnold (1909), but it is impossible to tell if they are in place, or large boulders adjacent to the sea cliff. Vertical exaggeration $\times 10$. (After K. Lajoie, 1997, written commun. and Powell, 1998, fig. 8).

as thick as 360 m (Clark and others, 1984); is overlain by Pleistocene terrace in sea-cliff exposures, especially near the mouth of San Gregorio Creek; and is separated from the other Purisima outcrops to the east by the San Gregorio Fault. One sample (Mf 3998; 77CB1725) collected west of the San Gregorio Fault and near the base of the measured section called “Upper part of the Tahana Member” by Cummings, Touring, and Brabb (1962, plate 22), near the mouth of Pescadero Creek (San Gregorio 7.5’ quadrangle), yields a diatom flora correlative with the late Miocene *N. reinholdii* Zone (fig. 4). Megafossils from the same general area are of late Miocene to early Pliocene age (Durham and Morgan, 1978), in general agreement with Cummings, Touring, and Brabb (1962).

A thick rhyolitic tuff bed crops out just north of San Gregorio Creek and west of the San Gregorio Fault. This tuff has yielded a zircon fission-track date of 5.2 ± 1.2 Ma (Naeser, written commun., 1983; *in* Gavigan, 1984). Sarna-Wojcicki (*in* Gavigan, 1984), using trace elements, correlated this tuff with the late Pliocene (3.3 Ma) Nomlaki Tuff, implying that the zircons dated by Naeser were probably detrital (reworked). Later, Sarna-Wojcicki and others (1991) and Sarna-Wojcicki (oral commun., 1996) revised their correlation and suggested

that this tuff is even younger and correlates with the Ishi Tuff, which is dated at its type locality at 2.6 Ma (late Pliocene) and can be no younger than ~ 2.4 Ma, which is the whole-rock K-Ar age of the overlying basalt of Cohasset Ridge (Harwood, Helley, and Doukas, 1981; Harwood and Helley, 1987). This age, however, is much younger than expected from lithologic correlations (Touring, 1959; Cummings, Touring, and Brabb, 1962) that assign these strata to the late Miocene Tahana Member. It is possible that the zircon fission-track age on the ash bed in the Purisima Formation at San Gregorio State Beach (Gavigan, 1984) is too young owing to underetching or too old owing to incorporation of older zircons into the analysis. However, the age of this tephra cannot be older than about 3.3 Ma, the age of the disseminated ash horizon found stratigraphically lower in the Purisima Formation, to the south (see Chronostratigraphic ages and correlation of the Purisima Formation, Tephrochronology, below). The fission-track date reported by Gavigan (1984) of 5.2 ± 1.2 Ma is based on a few zircon grains that were analyzed, which had a large individual dispersion in age, from about 2 to 8 Ma. It has not been determined if all or any of these grains are cogenetic grains of the tephra layer, or if the zircon sample includes xenocrystic

or detrital grains. The tephra layer is definitely water transported and deposited, and contains abundant detrital material, consequently the fission-track age cited by Gavigan (1984) may be correct, or may represent only a maximum age for the assemblage of grains analyzed. Megafossils described by Durham and Morgan (1978) from strata beneath this tuff are consistent with a late Miocene or early Pliocene age, which is more compatible with the older date of Naeser.

The occurrence of tephra beds near San Gregorio Beach and the bivalve mollusk *Patinopecten healeyi* (Dall) in the section restrict the age of at least the upper part of the section to the Pliocene, which is younger than the Tahana Member, which is entirely Miocene. Therefore, it seems likely that the Purisima Formation west of the San Gregorio Fault should not be assigned to the Tahana Member but to undifferentiated Purisima Formation.

San Gregorio Fault Offsets

Glen (1959, and oral commun., 1996) correlated the Purisima Formation (Pomponio Member) west of the Seal Cove Fault strand with the lithologically similar part of the type Purisima to the southeast and east of the San Gregorio Fault. The similarity of the foraminiferal faunas from these two sections (Goodwin and Thomson, 1954; R.S. Boettcher, written commun., 1996, in Clark, 1997) supports this cross-fault correlation and suggests an offset of 16 to 19 km.

The Purisima Formation sections at Point Año Nuevo, west of the Coastways strand of the San Gregorio Fault, and at Seal Cove west of the Seal Cove strand of the San Gregorio Fault have been offset from correlative sections to the east by right slip on this fault. Clark (1997) suggested that the Purisima Formation beds at Capitola Beach, between Soquel Creek and Tanner Gulch appeared to be offset about 19 km from the similar section east of Año Nuevo west of the San Gregorio (Coastways strand) Fault.

As older Neogene units are progressively offset more by right slip along the San Gregorio Fault, the Pomponio Member of early Pliocene age at Seal Cove should have been offset by a greater distance than the Año Nuevo section of late Pliocene age. This apparent similar or greater offset of the upper Pliocene section cannot be resolved here, but two possible explanations are offered—(1) uncertainties in projecting the upper Purisima sea cliff section that crops out near Capitola westward into the offshore San Gregorio Fault (Clark, 1997) or (2) some of the Pliocene slip on the San Gregorio Fault Zone to the north might have been accommodated by an offshore fault strand (McCulloch and others, 1977) in addition to slip on the inboard Seal Cove Fault strand.

Point Reyes Block

The Point Reyes structural block lies west of the San Andreas and San Gregorio Faults, where on the Point Reyes Peninsula in Marin County granitic and metamorphic rocks

of the Salinian block form the basement complex (fig. 1). The striking similarity along with the close similarity of overlying pre–upper Miocene sedimentary and volcanic rocks between Point Reyes granitic rocks and those of the Monterey Peninsula, suggested to Clark and others (1984) that the Point Reyes block had been offset by as much as 150 km of right slip along the San Gregorio Fault since late Miocene time. This Neogene fault offset has recently been refined to 156 ± 4 km by Dickinson and others (2005).

Siltstones and mudstones with a basal glauconitic sandstone unconformably overlying Salinian granitic rocks and Tertiary conglomerate, sandstone, and siltstone in the Point Reyes area west of the San Andreas Fault were named the Drakes Bay Formation by Galloway (1977). Clark and others (1984) assigned the siltstone and mudstone beds to the Purisima Formation on the basis of their lithologic and paleontologic similarity to the beds of the Purisima Formation in the Santa Cruz Mountains to the south. They assigned the basal glauconitic sandstone to the Santa Margarita Sandstone. Some of the stratigraphic relationships described by Galloway (1977, p. 30–31) are incorrect because he failed to differentiate the Santa Cruz Mudstone from the older Monterey Formation. The Purisima Formation rests unconformably on the Santa Margarita Sandstone and Santa Cruz Mudstone, not on the Monterey Formation.

Diatoms are common to abundant in the Purisima Formation, and several of these are illustrated by Galloway (1977, photos 14 and 15). G.D. Hanna, who identified the diatoms for Galloway, thought that they were late Miocene. Galloway apparently persuaded Hanna that they had to be Pliocene and must have been reworked. A reexamination of material collected by Galloway and stored at the California Academy of Sciences (CAS 1234, 37674, 40972) indicates that the samples are late Miocene Subzone b of the *Nitzschia reinholdii* Zone, similar in age to those in the type Tahana Member in the Santa Cruz Mountains. A diatom flora (Mf 4550) from about 335 m above the base of the formation (see appendix) is the same age.

Galloway (1977) also reported a small molluscan fauna from his Drakes Bay Formation, of uncertain stratigraphic position. All the taxa with the exception of the questionably identified echinoid *Megapetalus lovenoides* Clark cooccur from the Pliocene to Holocene. *Megapetalus lovenoides* Clark has been reported elsewhere only from the upper Miocene in Ventura County, southern California (Grant and Hertlein, 1938). Repenning and Tedford (1977) discussed an Otarioid seal and walrus from a part of the Drakes Bay Formation, which we assign to the Purisima Formation. They (1977, p. 81) believe that this pinniped fauna is late late Miocene or Pliocene, “possibly no older than 6 m.y. and possibly as young as 4 m.y.”

At Point Reyes National Seashore, J.D. Obradovich in Galloway (1977) reported glauconite from Galloway’s Drakes Bay Formation dated at 9.3 ± 0.5 Ma. Repenning and Tedford (1977) suggested the sample contained detrital biotite and may

be considerably younger. Recently, Clark (1997) recollected and processed this glauconite and obtained a K-Ar date of 7.9 ± 0.3 Ma. Clark and Brabb (1997) reassigned the sandstone beds from which the glauconite was collected to the Santa Margarita Sandstone. This age determination puts a lower limit on the age of the Purisima Formation in the Point Reyes area.

In addition, Galloway (1977) reported pine cones (*Pinus lawsoniana* Axelrod), and later Axelrod (1983) also reported Gowen Cypress (*Cupressus goveniana* Gordon) from rocks near the top of Galloway's Drakes Bay Formation. Repenning and Tedford (1977) suggested that the deposits containing the plant material overlie the Purisima Formation. This conclusion was supported by Axelrod (1983), who suggested that the fossil locality represents a turbidite deposit that rests unconformably on the Purisima Formation, and gives an approximate age of 500 ka for the deposit.

San Francisco Bay Block

This tectonic block lies northeast of the San Andreas Fault and is bounded to the northeast by the Hayward and Silver Creek Faults. It is characterized by a composite basement that includes Coast Range Ophiolite and the Franciscan Complex (McLaughlin and Clark, 2004). Northeast of the San Andreas Fault in the Santa Cruz Mountains this basement is overlain by as much as 1,500 m (4,900 ft) of Cretaceous strata of the Great Valley sequence, which is in fault contact with a Tertiary sedimentary section with minor volcanic rocks that ranges in age from Eocene to Pliocene and is as thick as 2,300 m (7,550 ft) (Clark, 1968).

No outcrops of the Purisima Formation are present in the San Francisco Bay tectonic block. A small outcrop of rocks attributed to undifferentiated Purisima Formation lies between the Pilarcitos and San Andreas Faults in Portola Valley (Esser, 1958; Mack, 1959, and Brabb and Pampeyan, 1983). These outcrops lie in the Santa Cruz tectonic block (as defined here) and little is known about them, although Mack (1959) reports as much as 2,000 feet of "siliceous siltstone, clayey siltstone, fine grained sandstone, and basal beds of coarse grained sandstone and conglomerate." He also reports a small fauna from 17 sites that indicate a Pliocene age.

Rocks previously attributed to the lower member of the Purisima Formation (of Arnold, 1908) east of the San Andreas Fault in San Mateo County contain a molluscan fauna of middle Miocene or "Temblor" California provincial molluscan stage age. These rocks are interbedded with the Page Mill Basalt that has been dated at 14.8 ± 2.4 Ma (Fox and others, 1985) and contain Relizian or Luisian (late early to middle middle Miocene) benthic foraminifers (Clark, 1968). They are now referred to the Ladera Sandstone (Pampeyan, 1993) and are not considered part of the Purisima Formation.

An upper Purisima Formation correlative in the San Francisco tectonic block is suggested by the late Pliocene molluscan fauna reported by Addicott (1969) near Stanford

University in Santa Clara County from the Merced(?) and Santa Clara Formations.

Chronostratigraphic Ages and Correlation of the Purisima Formation

An overview of the Purisima Formation in the Santa Cruz and Point Reyes structural blocks is presented in figure 4. This figure will help in understanding the age significance of the Purisima Formation in the various fault blocks.

Tephrochronology

At least five tephra layers of different composition and age are present in the Purisima Formation (fig. 5). These tephra layers range from discrete, relatively pure volcanic ash layers of differing thickness, to zones of impure, lenticular ash, or to zones of disseminated shards in stratigraphic sections otherwise barren of volcanic ash. Two of these five tephra layers occur west of the San Gregorio Fault in the Pigeon Point structural block—(1) in the vicinity of San Gregorio and Pomponio State Beaches and in road cuts along California Coast Highway 1 just east of Pomponio State Beach; and (2) between Pomponio and Pescadero State Beaches at the mouth of Long Gulch. Three of these tephra layers occur east of the San Gregorio Fault in the Santa Cruz structural block—(1) in a road cut along San Gregorio Road opposite the entrance to property at 5874 San Gregorio Road; (2) along Bridge Creek in the Laurel 7.5' quadrangle; and (3) in cliffs along West Cliff Drive, just west of Point Santa Cruz in the city of Santa Cruz.

The tephra layer exposed near San Gregorio and Pomponio State Beaches (PU-1, 7, 9; EH-UCD-PU-1), west of the San Gregorio Fault, are chemically similar the Ishi tuff in the Tuscan Formation of northeastern Sacramento Valley, exposed at Richardson Springs, and the same tuff (as established by correlation and sequence) present near the top of the marine San Joaquin Formation in the Kettleman Hills, Fresno County. The Ishi tuff was erupted from the southern Cascade Range volcanic province in northeastern California and has been dated in its source area by fission-track analysis on zircons at 2.6 ± 0.2 Ma, and the closely overlying basalt of Cohasset Ridge has been dated by the K-Ar method on whole rock at 2.4 ± 0.2 Ma (Harwood, Helley, and Doukas, 1981). Because in the near-source area of the Chico Monocline in northeastern Sacramento Valley the Ishi tuff is stratigraphically close to this overlying basalt and stratigraphically far above the Namlaki Tuff, dated 3.3 Ma, we believe that the average of these two dates (2.4 and 2.6 Ma, or 2.5 ± 0.2 Ma) more closely approximates the true age of the Ishi tuff, an age that is in general agreement. The average of these two dates is $\sim 2.5 \pm 0.2$ Ma (late Pliocene), which is in general agreement with the biostratigraphy, as the Pliocene (5.3 to 1.8 Ma; Lourens and others, 2004) index fossil *Patinopecten healeyi* (Dall) has

been collected in cliff exposures between San Gregorio and Pescadero State Beaches.

On the basis of chemical correlations, the disseminated tephra zone found near the mouth of Long Creek, near Pomponio Beach (PU-14), correlates well with the Putah Tuff (Member of the Tehama and Tuscan Formations), erupted from the northern Sonoma Volcanic field, and dated at ~3.3-3.4 Ma (Miller, 1966; Sarna-Wojcicki, 1976, McLaughlin and others, 2005). The strata containing this disseminated zone appear to underlie those containing the tephra mentioned above, so that the ages and stratigraphic relationships are consistent.

The ~40-cm-thick tephra layer exposed along San Gregorio Road (PU-17), east of San Gregorio Beach and east of the San Gregorio Fault, is chemically close to a tephra layer in the uppermost part of the Modelo Formation near South Mountain in Ventura County. The age of this tephra unit is estimated to be between 6.0 and 6.7 Ma (averaged age of ~6.4 ± 0.4 Ma), based on the presence of marine diatoms that place the stratigraphic interval containing the tephra within the upper *Nitzschia rheinholdii* Zone (John Barron, written commun. to A. Sarna-Wojcicki, 1986). This appears to be the oldest tephra layer found in the Purisima Formation. The eruptive source of this tephra is unknown, but the tephra in the Purisima Formation is chemically similar to units erupted from the Snake River Plain series of calderas (Perkins and others, 1995, 1998).

Other tephra discussed previously include (1) the tephra (76CB1624) from the Laurel 7.5' quadrangle north of Santa Cruz, which matches best with several samples of tephra believed to be precursors, or the preliminary plinian eruptions, of the Nomlaki Tuff (Member of the Tehama and Tuscan Formations), and (2) tephra (WC-3) from sea cliffs along West Cliff Drive, just west of Point Santa Cruz, in the city of Santa Cruz, which matches best with a tephra layer (upper of two) in the uppermost part of the Pancho Rico Formation, near Topo Valley in the Gabilan Range, San Benito County, where the correlative tephra layer is underlain by another tephra layer (JCD-5, 5A) that correlates to tephra layers dated in the range of 5.0 to 5.6 Ma.

Figure 5 shows the proposed correlations among the tephra layers in the Purisima Formation. The comparison of chemical compositions of tephra layers in the Purisima Formation with those in other sections in the region is given in appendix 3.

Mollusks

Molluscan faunas have long been used to correlate marine rocks in California. Powell (1998), using published literature and USGS megafossil collections, developed a molluscan biostratigraphy for the Purisima Formation and described three molluscan faunas—the La Honda, Pillar Point, and Santa Cruz, that aid in correlating the Purisima Formation with other nearby late Neogene formations. The La Honda fauna is assumed to have an age of late Miocene to early Pliocene, or “Jacalitos” and “Etchegoin” California provincial molluscan

stages (CPMS) age (Powell, 1998). The youngest Santa Cruz fauna has been assigned a Pliocene, “San Joaquin” CPMS age (Powell, 1998). The middle fauna, the Pillar Point fauna, occurs at one site west of the Seal Cove Fault and contains only a few species. The latter fauna is likely also to be “Jacalitos” and (or) “Etchegoin” CPMS in age, but lacks species to reliably make that determination and represents much deeper water than the La Honda or Santa Cruz faunas.

Based on these age determinations the La Honda fauna of Powell (1998) is probably correlative, at least in part, with similar faunas that occur in (1) the lower part of the basal sandstone member of the Pullen Formation (of Roth, 1979) in the Eel River Basin, (2) in the Ohlson Ranch Formation in northern Sonoma County (Peck, 1960), (3) in the lower part of the Wilson Grove Formation in Sonoma County (Powell, Allen, and Holland, 2004), (4) in the upper part of faunizone E and faunizone F of Adegoke (1969) in the Coalinga region of Fresno County, (5) in the Sisquoc Formation and Foxen Mudstone in the Santa Maria District (Woodring and Bramlette, 1950) of Santa Barbara County, and (6) in the Capistrano Formation in the San Joaquin Hills of Orange County (Vedder, 1972).

The Santa Cruz fauna is probably correlative with the similar faunas that occur (1) in the upper mudstone member of the Pullen, Eel River, and middle and lower members of the Rio Dell Formation (of Roth, 1979) in the Eel River Basin (supported by the occurrence of the Putah Tuff in the Eel River Formation of the Wildcat Group (Sarna-Wojcicki and others, 1982)); (2) in the upper part of the Wilson Grove Formation in Sonoma County (Powell, Allen, and Holland, 2004) (based on the occurrence of the bivalve mollusk *Nuttallia jamesii* Roth and Naidu at both the Opal Cliffs and in the upper part of the Wilson Grove Formation at River Road); (3) in the lower part of the Merced Formation on the San Francisco Peninsula (Glen, 1959; Yancey, 1978); (4) in the “Merced” Formation near Felt Lake, San Mateo County (Addicott, 1969); (5) in the Pancho Rico Formation (Durham and Addicott, 1965); (6) possibly faunizone G and faunizone H of Adegoke (1969) in the Coalinga region of Fresno County; (7) in the Careaga Sandstone in the Santa Maria District (Woodring and Bramlette, 1950) of Santa Barbara County; (8) in the Niguel Formation in the San Joaquin Hills in Orange County (Vedder, 1972; also cited as Capistrano Formation by Kern and Wicander, 1974, referred to the Niguel Formation by Groves, 1991); and (9) in the San Diego Formation in San Diego County (Hertlein and Grant, 1944; Deméré, 1982, 1983).

Diatoms

Marine diatom biostratigraphy is readily applicable to upper lower Miocene through lower Pliocene fine-grained rocks in California (Barron, 1986b). Correlation of this biostratigraphy to the North Pacific diatom biostratigraphy is straightforward (Barron and Isaacs, 2001), and numerous datum levels (first or last occurrences) have been tied directly

to the paleomagnetic timescale (Barron, 2003). Diatoms suggest that rocks of the lower to middle parts of the Purisima Formation range from Subzone a of the *Nitzschia reinholdii* Zone (7.4-6.7 Ma; latest Miocene) to the *Thalassiosira oestrupii* Zone (5.5-3.7 Ma, latest Miocene to early Pliocene) (fig. 4). Diatoms are poorly preserved and scarce in the upper parts of the Purisima Formation and thus cannot be used for biostratigraphy.

Strontium Isotopes

For this study, twenty-one shell or shell fragments of the aragonitic bivalve *Anadara trilineata* (Conrad) were selected for analysis from seven different samples (appendix 4) from five stratigraphic levels in the Santa Cruz section (fig. 2). In general, these ages are not consistent with other ages as determined by tephrochronology, diatoms, and magnetostratigraphy. The sample ages from about 75 m above the base appear to be too young, whereas the sample ages from about 190

m above the base appear to be too old. The reason for these discrepancies is unclear. The strontium isotopic ratios from the fossil material collected are reproducible and, within the variations shown in appendix 4, appear to represent the isotopic composition of strontium of the shells. All were measured on single shells or shell fragments of the same species, *Anadara trilineata* (Conrad), so any species-related biogenic fractionation should be common to all. Concentrations of strontium, manganese, and iron and the Sr/Mn ratio reported for these samples are consistent with unaltered carbonate and indicate minimal diagenetic alteration of the ⁸⁷Sr/⁸⁶Sr ratios. The general agreement of ⁸⁷Sr/⁸⁶Sr from different individual shells from the same sample argues against significant strontium exchange with ground water or seawater and suggests that the strontium ratios measured represent those of the waters in which these organisms grew. One possible explanation for the age differences is that *Anadara trilineata* (Conrad) near the top of the Santa Cruz section might have lived under restricted marine conditions.

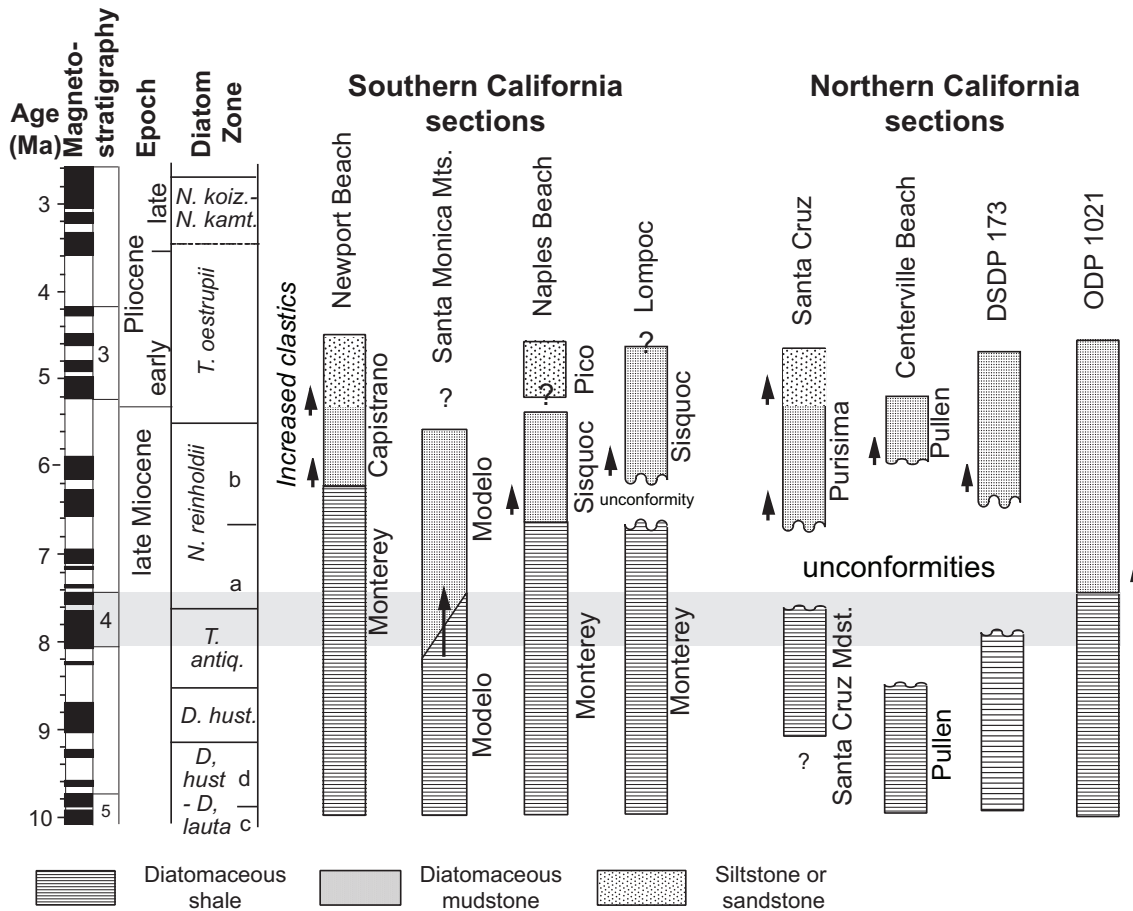

Figure 8. The circa 8 Ma change in motion between the Pacific and North American Plates (Atwater and Stock, 1998) marks the onset of increasing clastic input into onshore and offshore sections in coastal California. Diatomaceous shale of the Monterey Formation transitions into mudstones of the Purisima, Capistrano, and Sisquoc Formations during the latest Miocene coincident with widespread unconformities. Across the Miocene-Pliocene boundary, diatoms become increasingly rare in sediments as clastic input increases and diatom production declines. This figure is based on diatom data and does not show the full age range, determined here, of the Purisima Formation in the Santa Cruz section. (After Barron, 1986a,b, 1989, 1992, and Barron, Lyle, and Koizumi, 2001). Arrow indicates increase in percentage of clastic sedimentation. In the magnetic stratigraphy column black represents normal polarity, white represents reverse polarity.

Tectonic Implications

The change in motion between the Pacific and North American Plates at about 8 Ma (Atwater and Stock, 1998) coincided with the onset of regional tectonism in the California Coast Ranges (fig. 8). Between ~8 and 7 Ma, clastic sedimentation began increasing in marginal basins, marking the transition of the nearly pure diatomaceous shales of the Monterey Formation into the overlying diatomaceous mudstones of the Purisima, Sisquoc and Capistrano Formations (Barron, 1986b). This same 8 to 7 Ma interval of tectonism was characterized by widespread unconformities in coastal California and the North Pacific (Barron, 1986b, 1989). The diatomaceous mudstones of the lower parts of the Purisima and coeval units in coastal California become increasingly diatom poor and clastic rich upsection across the Miocene-Pliocene boundary (fig. 8). A combination of decreased coastal upwelling resulting in diminished diatom production (Barron, Lyle, and Koizumi, 2002) and increasing clastic input due to the uplift of the Coast Ranges and Sierra Nevada (Barron, 1992) is likely responsible for the generally poor representation of diatoms in lower Pliocene sediments in coastal California.

Conclusions

The age of the Purisima Formation ranges from ~6.5 to ~2.5 Ma, and the age range is different in different areas. The age and lithology of the Purisima Formation are very similar to those of the upper Etchegoin and San Joaquin Formations in the southwestern San Joaquin Valley. In addition, several of the same tephra layers found in the Purisima are also found in the correlative Pancho Rico and Paso Robles Formations in the Salinas Valley.

Moreover, the Purisima Formation appears to be severed and removed by the San Andreas Fault system from its former source of sediment supply. The crustal blocks containing the Purisima Formation, which lie entirely west of the San Andreas Fault, were at times partly or wholly contiguous with the ancestral southwestern San Joaquin Valley. During the period ~6 to ~2 Ma, sediments derived from of the San Joaquin Valley were transported to a marine embayment that occupied the present southwestern part of the San Joaquin Valley and the adjacent crustal block just to the southwest, across the San Andreas Fault. Right-lateral strike-slip motion on the San Andreas Fault moved the block situated to the southwest of the fault to the northwest, relative to the southeast block. The marine connection between the southwestern San Joaquin Valley and the Purisima basin was progressively elongated by the right-slip motion, and constricted by a smaller compressional component of plate motion (~10 percent of right slip), until the outlet was completely cut off by about 2.2 Ma. Alternatively, the southwestern San Joaquin Valley became emergent above sea level, with sediment transport continuing

along a subaerial outlet that followed the San Andreas Fault and which may have shifted to the west to follow the ancestral Salinas Valley sometime after 2.2 Ma. After 2.2 Ma, marine deposition in the uppermost San Joaquin Formation in the southwestern San Joaquin Valley was replaced by terrestrial deposition of the Tulare Formation.

The Purisima Formation thus probably represents the deformed shelf and slope deposits of a former basin (or basins) that was once contiguous with the southwestern Great Valley, and that was displaced and deformed by right-slip and compressional motion between the North American and Pacific Plates, along faults of the San Andreas Fault system, during the formation of the present central California Coast Ranges. The approximate displacement of the Purisima Formation from its sediment source thus ranges from a minimum of about 180 km (Kettleman Hills to Capitola), to a maximum of about 350 km (Kettleman Hills to Point Reyes). The latter distance represents a rate of about 5 cm/yr over the last 7 million years (Atwater and Stock, 1998), in approximate agreement with the long-term displacement rate of the San Andreas Fault system and the relative motion between the Pacific and the North American Plates.

Acknowledgments

The late Charles “Chuck” Repenning in 1977 first suggested to Joe Clark that the Drakes Bay Formation of Galiloway (1977) was really the Purisima Formation and provided much useful guidance during Clark’s early Point Reyes stratigraphic work. Richard Boettcher of Micropaleo Consultants, Inc., and Kristin McDougall of the U.S. Geological Survey identified foraminiferal faunules from the Purisima Formation of San Mateo County. We are also grateful to Chevron for making available stratigraphically important Purisima Formation samples from the type area of San Mateo County. Paul Russell, Jose Rivera, Kate Lormand, Robert Fehr, Michael Haemer, Andrew Brownstone, Andrew Erikson, Regina Broussard, Kristin Hepper, Michelle Dodge-Laviano, and Elmira Wan examined tephra samples and separated and purified volcanic glass for analysis; Charles E. Meyer, James P. Walker, Elmira Wan, and David Wahl analyzed the volcanic glass using an electron microprobe. James Henley, Jack Hillhouse, Robert McLaughlin, and Richard Stanley kindly reviewed the manuscript and made many helpful suggestions.

References Cited

- Addicott, W.O., 1969, Late Pliocene mollusks from San Francisco Peninsula, California, and their paleogeographic significance: *Proceedings of the California Academy of Sciences, Fourth Series*, v. 37, p. 57-93.

- Addicott, W.O., Barron, J.A., and Miller, J.W., 1978, Marine late Neogene near Santa Cruz, California, *in* Addicott, W.O., ed., Neogene biostratigraphy of selected areas in the California Coast Range. Field conference on marine Neogene of California, International Geological Correlation Programme, Project 114, June 21-24, 1978: U. S. Geological Survey Open-File Report 78-446, p. 97-109.
- Adegoke, O.S., 1969, Stratigraphy and paleontology of the marine Neogene formations of the Coalinga region, California: University of California Publications in Geological Sciences, v. 80, p. 1-241.
- Allen, J.E., 1945, Geology of the San Juan Bautista Quadrangle, California: Berkeley, Calif., University of California, Ph.D. dissertation, 94 p.
- Arnold, R., 1906, The Tertiary and Quaternary Pectens of California: U.S. Geological Survey Professional Paper 47, p. 1-146.
- Arnold, R., 1908, Descriptions of new Cretaceous and Tertiary fossils from the Santa Cruz Mountains, California: Proceedings of the United States National Museum, v. 34, p. 345-390.
- Ashley, G.H., 1895, The Neogene stratigraphy of the Santa Cruz Mountains of California: California Academy of Sciences, Second Series, 5, p. 273-367, reprinted in Stanford University Publications, Geology and Paleontology, v. 1, p. 18-367.
- Atwater, T.M., and Stock, J., 1998, Pacific-North America plate tectonics of the Neogene southwestern United States—An update: International Geology Review, v. 40, p. 375-402.
- Axelrod, D.I., 1983, New Pleistocene conifer records, coastal California: University of California Publications in Geological Science, v. 127, 108 p.
- Bandy, O.L., 1955, Evidence of displaced foraminifera in the Purisima Formation of the Halfmoon Bay area, California: Contributions to the Cushman Foundation for Foraminiferal Research, v. 6, p. 77-79.
- Barnes, L.G., 1976, Outline of eastern North Pacific fossil Cetacean assemblages: Systematic Zoology, v. 24, p. 321-343.
- Barron, J.A., 1986a, Paleooceanographic and tectonic controls on deposition of the Monterey Formation and related siliceous rocks in California: Palaeogeography, Palaeoclimatology, Palaeoecology, Symposium Volume, v. 27, p. 27-45.
- Barron, J.A., 1986b, An updated diatom biostratigraphy for the Monterey Formation of California, *in* Casey, R.G., and Barron, J.A., eds., Siliceous microfossils and microplankton studies of the Monterey Formation and its modern analogues: Pacific Section, Society of Economic Paleontologists and Mineralogists, Special Publication, Book 45, p. 105-119.
- Barron, J.A., 1989, Chapter 15, The late Cenozoic stratigraphic record and hiatuses of the northeast Pacific—Results from the Deep Sea Drilling Project *in* Winterer, E.L., Hussong, D.M., and Decker, R.W., eds., The Eastern Pacific Ocean and Hawaii, The geology of North America, Boulder, Colo., Volume N: Geological Society of America, p. 311-322.
- Barron, J.A., 1992, Pliocene paleoclimatic interpretation of DSDP Site 580 (NW Pacific) using diatoms: Marine Micro-paleontology, v. 20, p. 23-44.
- Barron, J.A., 2003, Appearance and extinction of planktonic diatoms during the past 18 m.y. in the Pacific and Southern oceans: Diatom Research, v. 18, p. 203-224.
- Barron, J.A. and Isaacs, C.M., 2001. Updated chronostratigraphic framework for the California Miocene, *in* Isaacs, C.M., and Rullkötter, J., eds., The Monterey Formation— from rocks to molecules: Columbia University Press, New York, N.Y., pp. 393-395.
- Barron, J.A., Lyle, M., and Koizumi, I., 2002, Late Miocene and early Pliocene biosiliceous sedimentation along the California margin, *in* Tsuchi, R, Barron, J.A., and MolinaCruz, A., eds., Proceedings of the VII-RCPNS, Mexico, 1999: Revista Mexican de Ciencias Geologicas, v. 19, no. 3, p. 161-169.
- Beechey, F.W., command, 1839, The zoology of Captain Beechey's voyage compiled from the collections and notes made by Captain Beechey, the officers and naturalists of the expedition, during a voyage to the Pacific and Behring's Straits performed in his Majesty's ship Blossom under the command of Captain F.W. Beechey, R.N., F.R.S., &c. &c—Richardson, J., Vigers, N.A., Lay, G.T., Bennett, E.T., Woen, R., Gray, J.E., Sowerby, G.B., Buckland, W., Belcher, E., and Collie, A., contributors, London, England, H.G. Bohn, p. i-xii and 1-180.
- Berggren, W.A., 1972, A Cenozoic time-scale—some implications for regional geology and paleobiogeography: Lethaia, v. 5, p. 195-215.
- Berggren, W.A., and Van Couvering, J.A., 1974, The late Neogene, Part 2—Neogene geochronology and chronostratigraphy, *in* Snelling, N.J., ed., Geochronology of the geological Record: Geological Society of London, Memoir 10, p. 211-250.
- Bernard, F.R., 1983, Catalogue of the living Bivalvia of the eastern Pacific Ocean: Bering Strait to Cape Horn: Canadian Special Publications of Fisheries and Aquatic Sciences, no. 61, 102 p.
- Brabb, E.E., 1989, Geologic map of Santa Cruz County, California: U.S. Geological Survey Miscellaneous Investigations Series Map I-1905, scale 1:62,500 (1 sheet).

- Brabb, E.E., and Pampeyan, E.H., 1983, Geologic map of San Mateo County, California: U.S. Geological Survey Miscellaneous Investigations Series Map I-1257A, scale 1:62,500.
- Branner, J.C., Newsom, J.F., and Arnold, R., 1909, Description of the Santa Cruz Quadrangle, California: U.S. Geological Survey Atlas, Folio 163, 11 p.
- Burke, W.H., Denison, R.E., Hetherington, E.A., Koepnick, R.B., Nelson, H.F., and Otto, J.B., 1982, Variation of seawater $^{87}\text{Sr}/^{86}\text{Sr}$ throughout Phanerozoic time: *Geology*, v. 10, p. 516-519.
- Cande, S.C., and Kent, D.V., 1995, Revised calibration of the geomagnetic polarity timescale for the Late Cretaceous and Cenozoic: *Journal of Geophysical Research-Solid Earth*, v. 100, p. 6093-6095.
- Clark, B.L., 1930, Tectonics of the Coast Ranges of middle California: *Bulletin of the Geological Society of America*, v. 41, p. 747-828.
- Clark, J.C., 1966, Tertiary stratigraphy of the Felton-Santa Cruz area, Santa Cruz Mountains, California: Stanford, Calif. Stanford University, Ph.D. dissertation, 184 p.
- Clark, J.C., 1968, Correlation of the Santa Cruz Mountains Tertiary—implications for San Andreas history, *in* Proceedings of conference on geologic problems of San Andreas Fault system: Stanford University Publications, Geological Sciences, v. 11, p. 166-180.
- Clark, J.C., 1981, Stratigraphy, paleontology, and geology of the central Santa Cruz Mountains, California Coast Ranges: U. S. Geological Survey Professional Paper 1168, 51 p.
- Clark, J.C., 1997, Neotectonics of the San Gregorio Fault Zone—age dating controls on offset history and slip rate: Final technical report, National Earthquake Hazards Reduction Program, Program element I—Evaluating national and regional hazard and risk (Award No. 1434-HQ-96-GR-02741), 30 p.
- Clark, J.C., and Brabb, E.E., 1997, Geology of Point Reyes National Seashore and vicinity, California—A digital database: U. S. Geological Survey Open-File Report 97-456, 8 and 16 p.
- Clark, J.C., Brabb, E.E., and Addicott, W.O., 1979, Tertiary paleontology and stratigraphy of the central Santa Cruz Mountains, California Coast Ranges: Geological Society of America, Cordilleran Section, Field Trip Guidebook, 23 p.
- Clark, J.C., Brabb, E.E., Greene, H.G., and Ross, D.C., 1984, Geology of Point Reyes Peninsula and implications for San Gregorio Fault history, *in* Crouch, J.K., and Bachman, S.B., eds., Tectonics and sedimentation along the California margin: Pacific Section, Society of Economic Paleontologists and Mineralogists, v. 38, p. 67-85.
- Clark, J.C., and Reitman, J.D., 1973, Oligocene stratigraphy, tectonics, and paleogeography southwest of the San Andreas Fault, Santa Cruz Mountains and Gabilan Range, California Coast Ranges: U.S. Geological Survey Professional Paper 783, 18 p.
- Coan, E.V., Scott, P.V., and Bernard, F.R., 2000, Bivalve shells of western North America—Marine bivalve mollusks from arctic Alaska to Baja California: Santa Barbara Museum of Natural History Monographs no. 2, Studies in Biodiversity no. 2, 764 p.
- Cooper, J.G., 1888, Catalogue of California fossils: California Mining Bureau, Seventh Annual Report, p. 221-308.
- Cummings, J.C., 1960, Geology of the Langley Hill-Waterman Gap area, Santa Cruz Mountains, California: Stanford, Calif. Stanford University, Ph.D. dissertation, 334 p.
- Cummings, J.C., Touring, R.M., and Brabb, E.E., 1962, Geology of the northern Santa Cruz Mountains, California, *in* Bowen, O.E., Jr., ed., Geologic guide to the gas and oil fields of northern California: California Division of Mines and Geology, Bulletin 181, p. 179-220.
- Dalrymple, G.B., 1979, Critical tables for conversion of K/Ar ages from old constants to new constants: *Geology*, v. 7, p. 558-560.
- Darrow, R.L., 1963, Age and structural relationships of the Franciscan Formation in the Montara Mountain Quadrangle: California Division of Mines and Geology Special Report 78, 23 p.
- Deméré, T.A., 1982, Review of the lithostratigraphy, biostratigraphy, and age of the San Diego Formation, *in* Abbott, P.L., ed., Geologic Studies in San Diego: San Diego Association of Geologists, Field Trips, p. 127-134.
- Deméré, T.A., 1983, The Neogene San Diego Basin—A review of the marine Pliocene San Diego Formation, *in* Larue, D.K. and Steel, R.J., eds., Cenozoic marine sedimentation Pacific margin, U.S.A: Pacific Section, Society of Economic Paleontologists and Mineralogists, p. 187-195.
- Dibblee, T.W., Jr., and Brabb, E.E., 1978, Preliminary geologic maps of the Chittenden, Los Gatos, and Watsonville East quadrangles, California: U. S. Geological Survey Open-File Report 78-453, scale 1:24,000.
- Dibblee, T.W., Jr., and Brabb, E.E., 1980, Preliminary geologic map of the Loma Prieta quadrangle, Santa Cruz and Santa Clara Counties, California: U. S. Geological Survey Open-File Report 80-944, scale 1:24,000.
- Dickinson, W.R., Ducea, M., Rosenberg, L.I., Greene, H.G., Graham, S.A., Clark, J.C., Weber, G.E., Kidder, S., Ernst, W.G., and Brabb, E.E., 2005, Net dextral slip, Neogene San Gregorio-Hosgri Fault Zone, coastal California—Geologic evidence and tectonic implications: The Geological Society of American Special Paper 391, 43 p.

- Dohrnwend, J.C., 1975, Plio-Pleistocene geology of the central Salinas Valley and adjacent uplands, Monterey County, California: Stanford, Calif., Stanford University, Ph.D. dissertation, 274 p.
- Dumont, M.P., Baldauf, J.G., and Barron, J.A., 1986, *Thalassiosira praeoestrupii*—a new diatom species for recognizing the Miocene/Pliocene epoch boundary in coastal California: *Micropaleontology*, v. 32, p. 372-377.
- Dumont, M.P., and Barron, J.A., 1995, Diatom biochronology of the Sisquoc Formation in the Santa Maria Basin, California, and its paleoceanographic and tectonic implications, in Keller, M.A., ed., *Evolution of sedimentary basins/offshore oil and gas investigations Santa Maria province*: U.S. Geological Survey Bulletin 1995K, p. K1-K17.
- Dumont, M.P. and Madrid, V.M., 1987, Magnetobiostratigraphy of the late Miocene Purisima Formation and the Miocene/Pliocene boundary in coastal California, in Barron, J.A., and Blueford, J.R., eds., *Abstract volume, Fourth International Congress on Pacific Neogene Stratigraphy* (Berkeley, Calif., July 29-31, 1987): p. 41.
- Durham, D.L., and Addicott, W.O., 1965, Pancho Rico Formation, Salinas Valley, California: U. S. Geological Survey Professional Paper 524A, p. A1-A22.
- Durham, J.W., and Morgan, S.R., 1978, New sand dollars (Echinoidea) of the genera *Merriamaster* and *Dendraster* from Purisima Formation, California: *Proceedings of the California Academy of Sciences, Fourth Series*, v. 41, p. 297-305.
- Esser, R.W., 1958, The reconnaissance geology of a part of the Woodside quadrangle, northeast of Skyline Boulevard, San Mateo County, California: Stanford, Calif., Stanford University, M.S. thesis, 78 p.
- Evernden, J.F., Savage, D.E., Curtis, G.H., and James, G.J., 1964, Potassium-argon dates and the Cenozoic mammalian chronology of North America: *American Journal of Science*, v. 262, p. 145-198.
- Fox, K.F., Jr., Fleck, R.J., Curtis, G.H., and Meyers, C.E., 1985, Implications of the northwesterwardly younger age of the volcanic rocks of west-central California: *Geological Society of America Bulletin*, v. 96, p. 647-654.
- Galehouse, J.S., 1967, Provenance and paleocurrents of the Paso Robles Formation, California: *Bulletin of the Geological Society of America*, v. 78, no. 8, p. 951-978.
- Galloway, A.J., 1977, Geology of the Point Reyes Peninsula, Marin County, California: California Division of Mines and Geology, Bulletin 202, 72 p.
- Gavigan, C.L., 1984, Composition and stratigraphy of the Purisima Formation in the central California Coast Ranges: Stanford, Calif., Stanford University, M.S. thesis, 111 p.
- Glen, W., 1959, Pliocene and lower Pleistocene of the western part of the San Francisco Peninsula: University of California Publications in Geological Sciences, v. 36, p. 147-198.
- Goodwin, J.C., and Thomson, J.N., 1954, Purisima Pliocene Foraminifera of the Halfmoon Bay area, San Mateo County, California: *Contributions to the Cushman Foundation for Foraminiferal Research*, v. 5, p. 170-178.
- Grant, U.S., IV, and Gale, H.R., 1931, Catalogue of the marine Pliocene and Pleistocene Mollusca of California: San Diego Society of Natural History Memoir, no. 1, 1,036 p.
- Grant, U.S., IV, and Hertlein, L.G., 1938, The west American Cenozoic Echinoidea: *Publications of the University of California at Los Angeles in Mathematical and Physical Sciences*, v. 2, 226 p.
- Greene, H.G., 1977, Geology of the Monterey Bay region: U.S. Geological Survey Open-File Report 77-718, 347 p.
- Groves, L.T., 1991, Paleontology and biostratigraphy of the Plio-Pleistocene lower Saugus Formation, Santa Susana Mountains, southern California: Northridge, Calif., California State University, M.S. thesis, 384 p.
- Haehl, H.L., and Arnold, R., 1904, The Miocene diabase of the Santa Cruz Mountains in San Mateo County, California: *American Philosophical Society Proceedings*, v. 43, p. 16-53.
- Haq, B.U., Hardenbol, J., and Vail, P.R., 1987, Chronology of fluctuating sea levels since the Triassic (250 million years ago to present): *Science*, v. 235, p. 1156-1167.
- Harwood, D.S., and Helley, E.J., 1987, Late Cenozoic tectonism of the Sacramento Valley, California: U.S. Geological Survey Professional Paper 1359, 46 p.
- Harwood, D.S., Helley, E.J., and Doukas, M.P., 1981, Geological map of the Chico monocline and northeastern part of the Sacramento Valley: U.S. Geological Survey Miscellaneous Investigations Map I-1238, scale 1:62,500.
- Hertlein, L.G., and Grant, U.S., IV, 1944, The geology and paleontology of the marine Pliocene of San Diego, California, part 1, *Geology: Memoirs of the San Diego Society of Natural History*, v. 2, p. 9-72.
- Hill, M.L., and Dibblee, T.W., Jr., 1953, San Andreas, Garlock, and Big Pines Faults, California: *Geological Society of America Bulletin*, v. 64, p. 443-458.
- Howarth, R.J., and McArthur, J.M., 1997, Statistics for strontium isotope stratigraphy, a robust LOWESS fit to the marine Sr-isotope curve for 0 to 206 Ma, with look-up table for derivation of numeric age: *Journal of Geology*, v. 105, p.441-456.
- Jones, W.P., 1911, The geology of the Sargent Oil Field: *Publications of the Department of Geology, University of California Publications*, v. 6, no. 3, p. 55-78.

- Kellogg, R., 1927, Fossil pinnipeds from California: Carnegie Institute of Washington, Publication 364, p. 25-37.
- Kern, J.P., and Wicander, E.R., 1974, Origin of a bathymetrically displaced invertebrate fauna in the upper part of the Capistrano Formation (lower Pliocene), southern California: *Journal of Paleontology*, v. 48, p. 495-505.
- Loomis, K.B., 1992, New K-Ar ages from the tuffs in the Etchegoin Formation, San Joaquin basin, California: *Isotopes*, no. 58, p. 3-7.
- Lourens, L., Hilgen, F., Shackleton, N.J., Laskar, J., and Wilson, D., 2004, The Neogene Period, *in* Gradstein, F., Ogg, J., and Smith, A., eds., *A geologic time scale 2004*: Cambridge University Press, New York, p. 409-440.
- Mack, J.E., 1959, Reconnaissance geology of the Woodside quadrangle, San Mateo County, California: Stanford, Calif., Stanford University, M.A. thesis, 78 p.
- Madrid, V.M., Stuart, R.M., and Verosub, K.L., 1986, Magnetostratigraphy of the late Neogene Purisima Formation, Santa Cruz County, California: *Earth and Planetary Science Letters*, v. 79, p. 431-440.
- Martin, B., 1916, The Pliocene of middle and northern California: University of California Publications, Bulletin of the Department of Geology, v. 9, p. 215-259.
- McArthur, J.M., Howarth, R.J., and Bailey, T.R., 2001, Strontium isotope stratigraphy; LOWESS Version 3; best fit to the marine Sr-isotope curve for 0-509 Ma and accompanying look-up table for deriving numerical age: *Journal of Geology*, v. 109, p. 155-170.
- McCulloch, D.S., Clarke, S.H., Jr., Field, M.E., Scott, E.W., and Utter, P.M., 1977, Summary report on the regional geology, petroleum potential, and environmental geology of the southern proposed lease sale 53, central and northern California outer shelf: U. S. Geological Survey Open-File Report 77-593, 57 p.
- McLaughlin, R.J., Clark, J.C., Brabb, E.E., Helley, E.J., and Colon, C.J., 2001, Geologic maps and structure sections of the southwestern Santa Clara Valley and northern Santa Cruz Mountains, California: U. S. Geological Survey Miscellaneous Investigations Map MF-2373, scale 1:24,000.
- McLaughlin, R.J., and Clark, J.C., 2004, Stratigraphy and structure across the San Andreas Fault Zone in the Loma Prieta region and deformation during the earthquake, *in* Wells, R.E., ed., *The Loma Prieta, California, earthquake of October 17, 1989—Geologic setting and crustal structure*: U.S. Geological Survey Professional Paper 1550-E, p. E5-E47.
- Perry, F.A., 1977, Fossils of Santa Cruz County: Santa Cruz, Calif., Santa Cruz City Museum, 32 p.
- Perry, F.A., 1993, Fossil invertebrates and geology of the marine cliffs at Capitola, California: Santa Cruz, Calif., Santa Cruz Museum Association, 30 p.
- Peterman, Z.E., Hedge, C.E., and Tourtelot, H.A., 1970, Isotopic composition of strontium in seawater throughout Phanerozoic time: *Geochimica Cosmochimica Acta*, v. 34, p. 105-120.
- Powell, C.L., II, 1998, The Purisima Formation and related rocks (upper Miocene–Pliocene), greater San Francisco Bay area, central California—Review of literature and USGS collections (now housed at the Museum of Paleontology, University of California, Berkeley): U.S. Geological Survey Open-File Report 98-594, 101 p.
- Powell, C.L., II, Allen, J.R., and Holland, P.J., 2004, Invertebrate paleontology of the Wilson Grove Formation (late Miocene to late Pliocene), Sonoma and Marin Counties, California, with some observations on its stratigraphy, thickness, and structure: U.S. Geological Survey Open-File Report 2004-1017, 106 p.
- Reinhart, P.W., 1943, Mesozoic and Cenozoic Arcidae from the Pacific Slope of North America: Geological Society of America, Special Paper 47, 117 p.
- Repenning, C.A., and Tedford, R.H., 1977, Otarioid seals of the Neogene: U. S. Geological Survey Professional Paper 992, 93 p.
- Roth, B., 1979, Marine invertebrates from northwest California and southwest Oregon: Berkeley, Calif., University of California, Ph.D. dissertation, 792 p.
- Sarna-Wojcicki, A.M., 1976, Correlation of late Cenozoic tuffs in the central Coast Ranges of California by means of trace- and minor-element chemistry: U.S. Geological Survey Professional Paper 972, 30 p.
- Sarna-Wojcicki, A.M., Bowman, H.R., Meyer, C.E., Russell, P.C., Woodward, M.J., McCoy, Gail, Rowe, J.J., Jr., Baedeker, P.A., Asaro, Frank, and Michael, Helen, 1984, Chemical analyses, correlations, and ages of upper Pliocene and Pleistocene ash layers of east-central and southern California: U.S. Geological Survey Professional Paper 1293, 40 p.
- Sarna-Wojcicki, A.M., Lajoie, K.R., Meyers, C.E., Adam, D.P., and Rieck, H.J., 1991, Tephrochronologic correlation of upper Neogene sediments along the Pacific margin, conterminous U.S., *in* Morrison, R.M., ed., *Quaternary nonglacial geology conterminous U.S.*: Boulder, Colo., Geological Society of America, *Geology of North American Geology*, v. K-2, p. 117-140.

- Sarna-Wojcicki, A.M., Wagner, J.R., Perkins, M.E., Lajoie, K.R., and Morrison, S.D., 1982, Introduction to the tectonic and stratigraphic setting of the Humboldt basin, Humboldt County, northwestern California, *in* Harden, D.R., Marron, D.C., and MacDonald, A., eds., Late Cenozoic history and forest geomorphology of Humboldt County, California. Friends of the Pleistocene 1982 Pacific Cell Field Trip Guidebook, Aug. 5-8, 1982, p. 46-62.
- Touring, R.M., 1959, Structure and stratigraphy of the La Honda and San Gregorio quadrangles, San Mateo County, California: Stanford, Calif., Stanford University, Ph.D. dissertation, 228 p.
- Vedder, J.G., 1972, Review of stratigraphic names and megafaunal correlation of Pliocene rocks along the southeast margin of the Los Angeles basin, California: Pacific Section, Society of Economic Paleontologists and Mineralogists, Proceedings of the Pacific Coast Miocene Biostratigraphic Symposium, p. 158-172.
- Valentine, J.W., 1961, Paleoecologic molluscan geography of the California Pleistocene: University of California Publications in Geological Sciences, v. 34, p. 309-442.
- Wagner, J.R., 1980, Summary of regional stratigraphic and geologic structure, *in* Evaluation of the potential for resolving the geologic and seismic issues at the Humboldt Bay Power Plant Unit No. 3, prepared for the Pacific Gas and Electric Company, appendix A: Woodward-Clyde Consultants, San Francisco, p. A1-A73.
- Weber, G.E., 1990, Late Pleistocene slip rates on the San Gregorio Fault Zone at Point Año Nuevo, San Mateo County, California: Pacific Section AAPG Volume and Guidebook, Book GB67, p. 193-203.
- Wiley, T.J., 1983, Pliocene shallow-water sediment gravity flows at Moss Beach, San Mateo County, California: Stanford, Calif., Stanford University, M.S. thesis, 57 p.
- Wiley, T.J., and Moore, E.J., 1983, Pliocene shallow-water sediment gravity flows at Moss Beach, San Mateo County, California, *in* Larue, D.K., and Steel, R.J., eds., Cenozoic marine sedimentation Pacific Margin, USA: Field trip guide, Pacific Section Society of Economic Paleontologists and Mineralogists, p. 29-43.
- Woodring, W.P., and Bramlette, M.N., 1950 [1951], Geology and paleontology of the Santa Maria district, California: U.S. Geological Survey Professional Paper 222, 185 p..
- Yancey, T.E., 1978, Stratigraphy of the Plio-Pleistocene strata in the Twelvemile Creek area, San Francisco Peninsula: Proceedings of the California Academy of Sciences, 4th Series, v. 41, p. 357-370.

Appendixes 1 – 4

Appendix 1. Diatom Floras From the Purisima Formation

[Mf – Microfossil locality register, U.S. Geological Survey, Menlo Park, California]

Pigeon Point Block

Año Nuevo 7.5' Quadrangle

Locality description.—Mf 3856 – Collected from diatomaceous shale approximately 15 m (50 ft) stratigraphically above basal sandstone and conglomerate in mudstone near base of cliff, Año Nuevo State Reserve, San Mateo Co., California. Collected by Earl Brabb, field number 76CB1534.

Latitude.—37.1134° N

Longitude.—122.3163° W

Age.—latest Miocene

Zone.—*Thalassiosira oestrupii* diatom Zone

Notes.—This sample contains *Thalassiosira nativa* suggesting that it belongs to the lowermost part of the *Thalassiosira oestrupii* Zone and is latest Miocene.

Point Reyes Block

Drakes Bay 7.5' Quadrangle

Locality description.—Mf 4550 – Diatomaceous shale collected 1.5 m stratigraphically above thick calcareous sandstone bed that projects out above beach, near axis of broad syncline and about 335 m above base of formation. Drakes Beach about 2.2 km southwest of public parking area and 265 m northeast of where large unnamed canyon comes down to beach, from near base of high sea cliff, Marin Co., California. Collected by J.C. Clark, field number JC77-2.

Latitude.—38.0129° N

Longitude.—122.9786° W

Age.—latest Miocene.

Zone.— Subzone b of the *Nitzschia reinholdii* Zone.

Notes.—This subzone is assigned to the latest Miocene interval between 6.7 and 5.5 Ma by Barron and Isaacs (2001). The assemblage correlates with assemblages in the Purisima Formation east of the San Gregorio Fault in the Santa Cruz Mountains to the south. Drakes Bay Formation of Galloway (1976), but assigned to the Purisima Formation by Clark and others (1984).

Locality description.—CAS 1234 - Diatomaceous shale collected from five miles (8 km) east of Point Reyes Light-house, from a road cut in center of the Point Reyes Peninsula, Marin Co., California. Collected by GD. Hanna, September 25, 1926.

Latitude.—37.95° N

Longitude.—122.82° W (These data plot in the ocean, but are given in the CAS database).

Age.—late Miocene

Zone.—Subzone b of the *Nitzschia reinholdii* Zone

Notes.—Moderately well-preserved diatoms include: *Thalassiosira antiqua* (common), *T. nativa*, *T. leptopus*, *Nitzschia rolandii*, and *Delphineis sachalinensis*.

Locality description.—CAS 40972 - Diatomaceous shale from about 3 m (10 ft) above resistant calcareous sandstone at axis of a syncline, where it is exposed at low tide, about 3.2 km (2 mi) west of the Park Headquarters at Drakes Beach, Point Reyes National Seashore, Marin Co., California. Collected by A.J. Galloway and GD. Hanna, July 7, 1968.

Latitude.—37.98° N

Longitude.—122.97° W (These data plots in the ocean, but are given in the CAS database).

Age.—late Miocene

Zone.—Subzone b of the *Nitzschia reinholdii* Zone

Notes.—Abundant, well-preserved diatoms include: *Thalassiosira antiqua* (common), *T. nativa*, *T. leptopus*, *Nitzschia rolandii* (few), *Delphineis sachalinensis*.

Santa Cruz Block

Felton 7.5' Quadrangle

Locality description.—Mf 3675 - From tuffaceous siltstone bed of the Purisima Formation about 18 m (60 ft) above the contact with Santa Margarita Sandstone in cut on north side of road in a new subdivision at an elevation of about 120 m (400 ft). NW1/4, NW1/4, section 6, T. 11 S., R. 1 W., Santa Cruz Co., California. Collected by J.C. Clark, field number L-83.

Latitude.—37.007° N

Longitude.—122.0153° W.

Age.—latest Miocene

Zone.—Subzone b of the *Nitzschia reinholdii* Zone.

Locality description.—Mf 3678 – Tuffaceous siltstone bed on side of hill behind Callaway house, east of Glen Canyon Road about 2.4 km (1.5 mi) south of Scotts Valley, Santa Cruz Co., California. Collected by J.C. Clark, field number L-2

Latitude.—37.022° N

Longitude.—122.020° W.

Age.—latest Miocene.

Zone.—correlative with the upper part of Subzone a of the *Nitzschia reinholdii* Zone (7.4-6.7 Ma).

Notes.—About 5 m (15 ft) above contact with Santa Margarita Sandstone and about 1 m (3 ft) above beds of Santa Cruz Mudstone.

Halfmoon Bay 7.5' Quadrangle

Locality description.—Concretion taken from rhythmically bedded siltstones of the Pomponio Siltstone Member of Purisima Formation, from a sea cliff above the beach and about 470 m (1550 ft) southeast of the mouth of Purisima Creek, Half Moon Bay 7.5' Quadrangle, San Mateo Co., California. Collected by Earl Brabb, field number 00CB5104.

Latitude.—37.3791 N

Longitude.—122.4124 W

Age.—Most likely early Pliocene based on the absence of *Thalassiosira nativa* and the relatively common occurrence of *Actinocyclus octonarius* and the presence of *Azpeitia nodulifera* var. *cyclopus*. These are warm-water forms that may be typical of the relatively warm early Pliocene. The absence of *T. oestrupii* is most likely due to environmental conditions unsuitable for its inclusion. The assumed age is 5.3 to 3.7 Ma based on the absence of *Thalassiosira nativa* and *Stephanopyxis dimorpha*.

Zone.—*Thalassiosira oestrupii* Zone

Note.—Common diatoms, moderate to good preservation. Fauna includes: *Actinocyclus octonarius* (few), *Actinoptychus* sp., *Azpeitia vetustissimus* (few to common), *A. nodulifera* (few), *A. nodulifera* var. *cyclopus* (rare), *Coscinodiscus* spp., *C. marginatus*, *Thalassiosira antiqua* (few), *T. praeoestrupii* (rare). Silicoflagellates: *Distephanus frugalis*, and *D. jimlingii*

La Honda 7.5' Quadrangle

Locality description.—Section beginning in Pescadero Creek, Memorial Park, with sample PMP-1, dolomitic concretion 13 m above the contact with Santa Cruz Mudstone, SW 1/4, section 34, T7S, R4W and extends northward along Pescadero Road, with stratigraphic thicknesses estimated by Brabb from geologic map of Touring (1959) and section BB of Cummings, Touring, and Brabb (1962), La Honda 7.5' quadrangle, San Mateo Co., California. Collected by J.A. Barron.

Latitude.—37.2752°N

Longitude.—122.2872°W

Age.—latest Miocene to earliest Pliocene?

Zone.—Sample PMP-1 - Subzone b of the *Nitzschia reinholdii* Zone.

Note.—Higher in the section along Pescadero Road are the following samples. P-1, estimated to be 640 m stratigraphically above the base of the Purisima Formation. Collected by John Barron in 1980 at a location on Pescadero Road., 200 m (650 ft) north, 290 m (950 ft) west of southeast corner section 27, T7S, R4W. Diatoms observed: *Nitzschia rolandii* (rare) *Thalassiosira antiqua* (common), *T. sp. cf. nativa* (few), *T. hyalinopsis* (rare), and *T. praeoestrupii* (rare). The assemblage would suggest that this sample predated the *T. oestrupii* Zone (ca. 5.9-5.5 Ma based on the presence of *T. praeoestrupii*); however, because this sample apparently is stratigraphically higher than sample PTT-2, which contains *T. oestrupii*, it is assumed that this sample should be correlated to the *T.*

Mindego Hill 7.5 Quadrangle

Locality description.—A section taken along Alpine Road, beginning at the SW1/4 of section 29, T7S, R3W, Mindego Hill 7.5' quadrangle at the unconformable contact with the underlying Woodhams Shale Member of the Monterey Formation, and extending southwestward along the road, San Mateo Co., California. Stratigraphic intervals estimated by Brabb from geologic sections prepared by Cummings (1960). Collected by J.A. Barron and R. Stuart. Base of section latitude — 37.2878° N

Longitude.—122.2186° W

Age.—latest Miocene

Zone.—All samples assignable to Subzone b of the *Nitzschia reinholdii* Zone. All samples except "PP-10" contain a warm water assemblage characterized by the overlap of *Nitzschia miocenica* and *Thalassiosira miocenica* and restricted to the interval between 6.4 and 6.2 Ma.

Notes.—PTT-6, directly overlying basal glauconite breccia, collected by Robert Stuart in 1982 at a location in the southwest corner section 29, T7S, R3W; PP-8, estimated to be 4 m stratigraphically above the base of the Purisima Formation, collected by Robert Stuart in 1982 at a location 128 m (420 ft) north, 472 m (1,550 ft) east of southwest corner section 29, T7S, R3W; PTT-7, estimated to be 11 m stratigraphically above the base of the Purisima Formation, collected by Robert Stuart in 1982 at a location about 10 m above PTT-6, SW1/4 of section 29, T7S, R3W; PP-9, estimated to be 30 m stratigraphically above the base of the Purisima Formation, collected by Robert Stuart in 1982 at a location 280 m (920 ft) north, 220 m (720 ft) east, of southwest corner section 29, T7S, R3W; PP-11, estimated to be 130 m stratigraphically above the base of the Purisima Formation, collected by Robert Stuart in 1982 at a location 503 m (1,650 ft) north, 700 m (2,300 ft) east of southwest corner section 30, T7S, R3W; PP-10, estimated to be 141 m stratigraphically above the base of the Purisima Formation, collected by Robert Stuart in 1982 at a location 204 m (670 ft) north, 448 m (1,470 ft) west of southeast corner section 30, T7S, R3W. Diatoms observed: *Azpeitia vetustissimus* (rare), *Lithodesmium minusculum* (rare), *Nitzschia miocenica* (rare), *Nitzschia reinholdii* (rare), *N. rolandii* (rare), *Thalassiosira antiqua* (few), *Thalassiosira miocenica* (rare), and *T. sp. cf. nativa* (few).

Locality description.—A section taken along Portola State Park Road, beginning at the SE1/4, section 32, T7S, R3W, Mindego Hill 7.5' quadrangle at the unconformable contact with the underlying Woodhams Shale Member of the Monterey Formation, and extending southward along the road, San Mateo Co., California. Stratigraphic intervals estimated by Brabb from geologic sections prepared by Cummings (1960). Collected by J.A. Barron and R. Stuart.

Base of section latitude.—37.2784° N

Longitude.—122.2109° W

Age.—latest Miocene

Zone.—All samples assignable to Subzone b of the *Nitzschia reinholdii* Zone; all samples except “W-3” contain a warm water assemblage characterized by the overlap of *Nitzschia miocenica* and *Thalassiosira miocenica* and restricted to the interval between 6.4 and 6.2 Ma.

Notes.—PTT-4, collected in 1982 by Robert Stuart on Portola State Park Rd., a few meters above unexposed contact with underlying Monterey Formation, SE 1/4, section 32, T7S, R3W; W-4, estimated to be 20 m stratigraphically above the base of the Purisima Formation, collected by J.A. Barron in 1980 at a location 640 m (2,100 ft) north, 564 m (1,850 ft) west of southeast corner section 32, T7S, R3W; W-3, estimated to be 50 m stratigraphically above the base of the Purisima Formation, collected by J.A. Barron in 1980 at a location 670 m (2,200 ft) north, 543 m (1,780 ft) west of southeast corner section 32, T7S, R3W; W-2, estimated to be 80 m stratigraphically above the base of the Purisima Formation, collected by J.A. Barron in 1980 at a location 670 m (2,220 ft) north, 503 m (1,650 ft) west of southeast corner section 32, T7S, R3W; PP-7, estimated to be 165 m stratigraphically above the base of the Purisima Formation, collected by J.A. Barron in 1980 at a location 488 m (1,600 ft) north, 564 m (1,850 ft) west of southeast corner section 32, T7S, R3W; PP-6, estimated to be 256 m stratigraphically above the base of the Purisima Formation, collected by Robert Stuart in 1982 at a location 34 m (110 ft) north, 588 m (1,930 ft) west of southeast corner section 32, T7S, R3W; PP-5, estimated to be 256 m stratigraphically above the base of the Purisima Formation, collected by Robert Stuart in 1982 at a location 760 m (2,500 ft) south, 430 m (1,400 ft) west of southeast corner, section 5, T8S, R3W. Diatoms observed: *Azpeitia vetustissimus* (rare), *Lithodesmium minusculum* (rare), *Nitzschia miocenica* (rare), *Nitzschia reinholdii* (rare), *N. rolandii* (rare), *Thalassiosira antiqua* (few), *Thalassiosira miocenica* (rare), and *T. sp. cf. T. nativa* (few).

Santa Cruz 7.5' Quadrangle

Locality description.—Mf 3676 - Tuffaceous siltstone beds of Purisima Formation from cut on east side of parking lot, 30 m (100 ft) south of Water Street in Santa Cruz, SW1/4, section 7, T. 10 S., R. 1 W, Santa Cruz Co., California. Collected by J.C. Clark, field number L-103.

Latitude.—36.981° N

Longitude.—122.016° W.

Age.—latest Miocene

Zone.—Correlates with Subzone b of the *N. reinholdii* Zone.

Formation.—Purisima Formation about 6-9 m (20-30 ft) above contact with Santa Cruz Mudstone.

Locality description.—Mf 3677 - Tuffaceous siltstone bed of Purisima Formation shown as “Mm” on Santa Cruz sheet of geologic map of California, 1959. About 6-9 m (20-30 ft) above contact with Santa Cruz Mudstone collected from cut

on north side of Highland Avenue just north of sharp curve in Santa Cruz, NW1/4, section 13, T. 11 S., R. 2 W, Santa Cruz Co., California. Collected by J.C. Clark, field number L-104.

Latitude.—36.9767° N

Longitude.—122.0361° W.

Age.—latest Miocene

Zone.—Correlates with Subzone a of the *N. reinholdii* Zone.

Appendix 2. Locations of Tephra Samples From the Purisima Formation

Pigeon Point Tectonic Block

PU-1, PPU-7—Disturbed composite bed of water-lain tephra, ~1.2 m thick, in fine-sand and silt sized sediments of the marine Purisima Formation. Chalky, poorly indurated, light creamy-gray tephra, impure, consisting of alternately more- and less-pure tephra lenses about 5-15 cm thick. Exposed in sea cliff at north end of San Gregorio State Beach, ~1-3 m above base of cliff, ~200 m north of the mouth of San Gregorio Creek, ~200 m west of California Highway 1. GPS coordinates: N 37.32279, W -122.40179. San Gregorio 7.5' quadrangle, San Mateo Co., California. Collected by A. Sarna-Wojcicki.

PU-9A, 9B.—From ~20-cm-thick, compound, reworked, water-lain tephra bed stratigraphically 8 m below thick tephra bed (equivalent to PU-1, 7?; see above), in fine sands, silts and clays of the Purisima Formation, exposed in sea cliff at south end of San Gregorio Beach, ~400 m south of mouth of San Gregorio Creek. Sample PU-9A is white, fine, impure ash from basal 8 cm of this bed. Sample PU-9B is gray, coarser (?), impure ash from the upper 8-16 cm of this bed. The uppermost bed was not sampled here. This locality is ~0.60 km due south of the locality of samples PU-1., etc., above, San Gregorio 7.5' quadrangle, San Mateo Co., California. Collected by A. Sarna-Wojcicki.

PU-14.—Poorly-indurated tuff or ash bed, ~1 m thick, impure, light-gray, laminated to finely bedded and cross bedded, generally fine sand to silt size, exposed on north side of Long Gulch, ~60 m east of the back beach/sea cliff at the coast, ~0.56 km south of the mouth of Pomponio Creek. This bed is the most tuffaceous (lightest in color) of several that can be seen within an interval of up to 8-10 m above this bed. This ~1-m-thick tuffaceous bed rests with a sharp, planar contact on a thick (>2-m) bed of coarse, medium-brown sand that contains rounded clasts of lighter-colored, finer-grained material similar in color and grain size to the ~1-m-thick tuffaceous bed. These clasts are concentrated only in the upper ~1 m of the coarse, ~2-m sand bed. These tuffaceous beds are long lenses that thicken and thin over distances of several tens of meters but seldom persist for more than 100-200 m. They appear to define a zone about 10 m thick within this part of the Purisima Formation. Some of the beds are contorted,

presumably from slumping. GPS coordinates: N 37.29165, W -122.40573. Elevation from map ~2-4 m above sea level. San Gregorio 7.5' quadrangle, San Mateo Co., California. Collected by A. Sarna-Wojcicki.

PU-16A (04).—From exposure in road cut on east side of California Highway 1, ~1/4 mile north of entrance to Pomponio State Beach. Greenish to tan marine sediments of the Purisima Formation, fine sands and silts, contorted here, contain lenses of light gray to chalky, impure ash. Sample collected from ~3.5-4 m below contact with overlying marine terrace sediments. Purer-looking ash was picked from a chalky layer 5-10 cm thick; base looked fairly pure but less pure in the upper part of the bed. May dip shallowly to the south. GPS coordinates: N 37.30373, W -122.40355. Elevation 40 m (GPS), San Gregorio 7.5' quadrangle, San Mateo Co., California. Collected by A. Sarna-Wojcicki.

EH-UCD-PU-1.—Sample from the same or nearby locality as PU-16 (see above), south of San Gregorio Beach but north of Pomponio Beach, San Gregorio 7.5' Quadrangle, San Mateo Co., California. Collected by Erik Holm, at the time at University of California, Davis (Holm, 1991).

PU-16B (04).—Undisturbed, light-colored ashy layer varying from ~10 to ~25 cm thick. In shallow road cut on west side of California Highway 1, almost directly across the highway from sample PU-16A (see above), San Gregorio 7.5' quadrangle, San Mateo Co., California. Collected by A. Sarna-Wojcicki.

PU-16C (04).—Ashy sand and silt from 3-4 cm directly beneath sample PU-16B (see above). Contains shards identical in chemical composition to those in samples PU-16A and

B, indicating that tephra is reworked and water-deposited, San Gregorio 7.5' quadrangle, San Mateo Co., California. Collected by A. Sarna-Wojcicki.

PU-17.—Tuff bed, light-to-medium gray, well indurated, ~40 cm thick, interbedded with shales and poorly sorted fine sandstone, in road cut on north side of San Gregorio Road (California Highway. 84), opposite driveway to residence at 5874 San Gregorio Rd. GPS coordinates: N 37.31484, W -122.30665. 6 satellites. Elevation 79 m (GPS), ~97 m from topographic map. La Honda 7.5' quadrangle, San Mateo Co., California. Collected by A. Sarna-Wojcicki.

Santa Cruz Tectonic Block

76CB1624.—Sample collected from Bridge Creek, about 1,500 feet north of its intersection with Aptos Creek, an estimated 1,000 feet stratigraphically above the base of the Purisima Formation, and about 3,000 feet south of an outcrop of granitic basement rocks. Laurel 7.5' quadrangle, Santa Cruz Co., California. Collected by Earl Brabb.

WC-3.—Grayish-white vitric tuff, massive, weakly bioturbated, grades upward into massive, very-fine, poorly sorted, bioturbated sandstone; underlain by greenish-gray micaceous, intensely bioturbated, muddy, very fine and fine sandstone. Exposed in sea cliff just west of West Cliff Drive, ~0.5 km north of Point Santa Cruz (Madrid, Stuart, and Verosub, 1986). N 36.9519, W -122.0331. Santa Cruz 7.5' quadrangle, Santa Cruz, Santa Cruz Co., California. Collected by V.M. Madrid and R.M. Stuart.

Appendix 3. Tephra Layers in the Purisima Formation, West-Central California, and Correlative Units

Appendix 3A. Ash in the Purisima Formation, San Gregorio and Pomponio Beach areas (E. Holm, sample 1877; A.M. Sarna-Wojcicki, remaining samples).

[Mean compositions of sample groups, bold, are grouped with the closest chemical match, below. All numbers are percentage by weight]

Tephra Data-base No.	Sample Number	Date	SiO ₂	Al ₂ O ₃	Fe ₂ O ₃	MgO	MnO	CaO	TiO ₂	Na ₂ O	K ₂ O	Total R ¹
589	PU-1(2), T18-1(2)	6//83	77.96	12.44	0.85	0.15	0.03	0.78	0.14	3.72	3.94	100.01
302	PU-1, T18-1	-	77.92	12.57	0.78	0.13	0.04	0.75	0.15	3.69	3.97	100.00
303	PU-7, T15-1, low total	-	78.19	12.53	0.85	0.13	0.05	0.71	0.18	3.35	4.01	100.00
2541	PU-9A T224-7	4/22/91	77.71	12.71	0.88	0.15	0.04	0.78	0.20	3.70	3.85	100.02
2542	PU-9B T224-8	4/22/91	77.68	12.70	0.86	0.15	0.05	0.78	0.18	3.69	3.92	100.01
1877	EH-UCD-PU-1 T148-9	10/27/87	78.68	12.07	0.81	0.15	0.04	0.77	0.17	3.43	3.89	100.01
5380	PU-16A (04) T527-7	7/12/00	78.33	12.60	0.80	0.15	0.04	0.77	0.15	3.25	3.90	99.99
5381	PU-16B (04) T527-8	7/12/00	78.31	12.57	0.87	0.16	0.04	0.78	0.16	3.32	3.80	100.01
5382	PU-16C (04) T527-9	7/12/00	78.28	12.69	0.81	0.15	0.04	0.75	0.15	3.25	3.88	100.00
Mean (9)			78.12	12.54	0.83	0.15	0.04	0.76	0.16	3.49	3.91	100.01
Standard Deviation			0.33	0.20	0.04	0.01	0.01	0.02	0.02	0.21	0.06	0.01

¹ Total oxide weight percent, recalculated to a fluid-free basis

Appendix 3B. Ishi Tuff (~2.5 Ma), Chico Monocline, eastern Sacramento Valley (collected by D.S. Harwood), and correlative tuff, Kettleman Hills, San Joaquin Valley (collected by A.M. Sarna-Wojcicki) (>2.2 Ma, <3.30 Ma).

[Mean compositions of sample groups, bold, are grouped with the closest chemical match, below. All numbers are percentage by weight]

Tephra Database No.	Sample Number	Date	SiO ₂	Al ₂ O ₃	Fe ₂ O ₃	MgO	MnO	CaO	TiO ₂	Na ₂ O	K ₂ O	Total R ¹
333	RS-2(1), T32-8	-	77.76	12.74	0.82	0.14	0.02	0.75	0.15	3.50	4.12	100.00
334	RS-2(2), T34-6	-	77.51	12.82	0.81	0.16	0.02	0.74	0.15	3.39	4.40	100.00
593	RS-2(3), T67-13	11/18/83	77.94	12.48	0.85	0.14	0.05	0.78	0.13	2.81	4.78	99.99
664	KT-11A, T64-2	9/6/83	78.47	12.16	0.86	0.14	0.04	0.77	0.16	3.59	3.81	100.00
665	KT-11B, T64-3	9/6/83	78.71	11.95	0.90	0.14	0.03	0.78	0.18	3.57	3.74	100.00
Mean (5)			78.08	12.43	0.85	0.14	0.03	0.76	0.15	3.37	4.17	100.00
Standard Deviation			0.50	0.37	0.85	0.01	0.03	0.02	0.02	0.32	0.42	0.00

¹ Total oxide weight percent, recalculated to a fluid-free basis

Appendix 3C. Ash in Purisima Formation, northeast of Santa Cruz (collected by E. Brabb).

Tephra Data-base No.	Sample Number	Date	SiO ₂	Al ₂ O ₃	Fe ₂ O ₃	MgO	MnO	CaO	TiO ₂	Na ₂ O	K ₂ O	Total R ¹
1370	76C1624 T104-10	8/26/85	77.95	12.57	0.95	0.15	0.03	0.90	0.20	3.59	3.65	99.99

¹ Total oxide weight percent, recalculated to a fluid-free basis

Appendix 3D. Tephra of earliest (?) eruptions of Nomlaki Tuff and ash flows, northern Sacramento Valley (collected by A.M. Sarna-Wojcicki and D.S. Harwood) (> or = to ~3.30 Ma).

[Mean compositions of sample groups, bold, are grouped with the closest chemical match, below. All numbers are percentage by weight]

Tephra Database No.	Sample Number	Date	SiO ₂	Al ₂ O ₃	Fe ₂ O ₃	MgO	MnO	CaO	TiO ₂	Na ₂ O	K ₂ O	Total R ¹
244	OLD COW-3, T27-4	-	77.58	12.52	0.99	0.16	0.04	0.91	0.20	4.04	3.56	100.00
3556	DCNT-1 T329-	8/30/95	78.43	13.15	0.99	0.17	0.03	0.90	0.20	2.45	3.69	100.01
3849	758-322 T355-10	1/97	77.54	12.80	1.00	0.17	0.03	0.86	0.20	3.73	3.67	100.00
1053	MIL-11DG T79-2	7/27/84	78.00	12.30	0.95	0.16	0.04	0.89	0.23	3.82	3.59	99.98
Mean (4)			77.89	12.69	0.98	0.17	0.03	0.89	0.21	3.51	3.63	100.00
Standard Deviation			0.42	0.37	0.02	0.01	0.01	0.02	0.02	0.72	0.06	0.01

¹ Total oxide weight percent, recalculated to a fluid-free basis

Appendix 3E. Disseminated volcanic glass shards in Purisima Formation, between Pomponio and Pescadero Beaches, at the mouth of Long Gulch, west of the San Gregorio Fault (collected by A.M. Sarna-Wojcicki).

[All numbers are percentage by weight]

Tephra Database No.	Sample Number	Date	SiO ₂	Al ₂ O ₃	Fe ₂ O ₃	MgO	MnO	CaO	TiO ₂	Na ₂ O	K ₂ O	Total R ¹
2543	PU-14 T225-1	4/22/19	75.80	12.88	1.67	0.09	0.02	0.60	0.16	3.89	4.88	99.99

¹ Total oxide weight percent, recalculated to a fluid-free basis

Appendix 3F. Putah Tuff, proximal and distal localities (collected by A.M. Sarna-Wojcicki and R.J. McLaughlin) (~3.30 Ma).

[Mean compositions of sample groups, bold, are grouped with the closest chemical match, below. All numbers are percentage by weight]

Tephra Database No.	Sample Number	Date	SiO ₂	Al ₂ O ₃	Fe ₂ O ₃	MgO	MnO	CaO	TiO ₂	Na ₂ O	K ₂ O	Total R ¹
4898	MRM-1-01 T480-3	6/22/02	75.90	13.02	1.66	0.07	0.03	0.58	0.17	3.72	4.83	99.98
4884	01517E T477-2	4/2/02	76.07	12.62	1.67	0.08	0.02	0.61	0.18	3.90	4.86	100.01
354	SM-ASH-08, T20-10	-	76.01	12.87	1.73	0.08	0.01	0.63	0.16	4.09	4.41	99.99
477	758-287D(2), T19-8	-	75.96	13.04	1.69	0.07	0.04	0.61	0.17	4.11	4.30	99.99
5277	MRM01-04A T515-6	8/24/04	75.80	13.13	1.73	0.08	0.03	0.62	0.16	2.74	5.71	100.00
3554	PVR-2 T328-3	8/30/95	75.61	13.21	1.74	0.09	0.03	0.61	0.18	4.03	4.51	100.01
Mean (6)			75.89	12.98	1.70	0.08	0.03	0.61	0.17	3.77	4.77	100.00
Standard Deviation			0.17	0.21	0.03	0.01	0.01	0.02	0.01	0.52	0.51	0.01

¹ Total oxide weight percent, recalculated to a fluid-free basis

Appendix 3G. Ash in basal Paso Robles Formation, Topo Valley (collected by J.C. Dohrnwend).

[Mean compositions of sample groups, bold, are grouped with the closest chemical match, below. All numbers are percentage by weight]

Tephra Data- base No.	Sample Number	Date	SiO ₂	Al ₂ O ₃	Fe ₂ O ₃	MgO	MnO	CaO	TiO ₂	Na ₂ O	K ₂ O	Total R ¹
146	JCD-1(1), T19-6	-	73.65	14.32	2.25	0.08	0.03	1.06	0.17	4.39	4.04	99.99
147	JCD-1(2), T3, 4, N-ASW-17	-	73.55	14.82	2.14	0.08	0.05	1.02	0.17	4.06	4.11	100.00
148	JCD-1(3), T19-7	-	73.48	14.35	2.16	0.07	0.04	1.08	0.16	4.50	4.16	100.00
Mean (4)			73.56	14.50	2.18	0.08	0.04	1.05	0.17	4.32	4.10	100.00
Standard			0.09	0.28	0.06	0.01	0.01	0.03	0.01	0.23	0.06	0.01
Deviation												

¹ Total oxide weight percent, recalculated to a fluid-free basis

Appendix 3H. Ash in Huichica Formation ("Huichica Tuff"; collected by A.M. Sarna-Wojcicki) (4.71 Ma).

[Mean compositions of sample groups, bold, are grouped with the closest chemical match, below. All numbers are percentage by weight]

Tephra Database No.	Sample Number	Date	SiO ₂	Al ₂ O ₃	Fe ₂ O ₃	MgO	MnO	CaO	TiO ₂	Na ₂ O	K ₂ O	Total R ¹
138	H1, T3, 4	-	73.56	14.62	2.29	0.09	0.06	1.05	0.19	4.44	3.70	100.00
3526	H-2 T326-1	7/6/95	73.52	14.41	2.21	0.08	0.05	1.03	0.15	4.52	4.03	100.00
456	758-84, T1-T2, P	-	73.35	14.47	2.29	0.10	0.05	1.09	0.18	4.83	3.65	100.01
457	758-86, T7-15	-	74.18	14.46	2.27	0.11	0.06	1.03	0.18	4.14	3.57	100.00
Mean (4)			73.65	14.49	2.27	0.10	0.06	1.05	0.18	4.48	3.74	100.00
Standard Deviation			0.36	0.09	0.04	0.01	0.01	0.03	0.02	0.28	0.20	0.01

¹ Total oxide weight percent, recalculated to a fluid-free basis

Appendix 3I. Ash in Purisima Fm., west of Pt. Santa Cruz (collected by R. Stewart and V. Madrid).

Tephra Database No.	Sample Number	Date	SiO ₂	Al ₂ O ₃	Fe ₂ O ₃	MgO	MnO	CaO	TiO ₂	Na ₂ O	K ₂ O	Total R ¹
1369	WC-3 T104-9	8/26/85	75.25	13.95	1.64	0.28	0.05	1.14	0.31	3.87	3.51	100.00

¹ Total oxide weight percent, recalculated to a fluid-free basis

Appendix 3J. Upper ash in uppermost Pancho Rico Formation, beneath Paso Robles Formation, Topo Valley (collected by J.C. Dohrnwend).

[Mean compositions of sample groups, bold, are grouped with the closest chemical match, below. All numbers are percentage by weight]

Tephra Database No.	Sample Number	Date	SiO ₂	Al ₂ O ₃	Fe ₂ O ₃	MgO	MnO	CaO	TiO ₂	Na ₂ O	K ₂ O	Total R ¹
1770	JCD-3 T139-1	5/28/87	74.97	13.63	1.64	0.32	0.07	1.13	0.32	4.50	3.40	99.98
3793	JCD-3A T350-6	12/96	75.04	13.73	1.65	0.31	0.06	1.17	0.27	4.27	3.49	100.01
3796	JCD-5 minor T350-8	12/96	75.07	14.69	1.69	0.32	0.06	1.20	0.28	3.42	4.28	100.01
Mean (3)			75.03	13.69	1.66	0.32	0.06	1.17	0.29	4.06	3.72	100.00
Standard Deviation			0.05	0.06	0.03	0.01	0.01	0.04	0.03	0.57	0.48	0.02

¹ Total oxide weight percent, recalculated to a fluid-free basis

Appendix 3K. Lower ash in uppermost Pancho Rico Formation, beneath upper ash, Topo Valley (collected by J. Dohrnwend).

[Mean compositions of sample groups, bold, are grouped with the closest chemical match, below. All numbers are percentage by weight]

Tephra Database No.	Sample Number	Date	SiO ₂	Al ₂ O ₃	Fe ₂ O ₃	MgO	MnO	CaO	TiO ₂	Na ₂ O	K ₂ O	Total R ¹
3795	JCD-5 T350-8	12/96	77.20	12.72	0.98	0.16	0.03	0.82	0.15	3.19	4.75	100.00
1769	JCD-5A T139-2	5/28/87	77.01	12.79	1.01	0.19	0.04	0.85	0.21	3.63	4.28	100.01
Mean (2)			77.11	12.76	1.00	0.18	0.04	0.84	0.18	3.41	4.52	100.01

¹ Total oxide weight percent, recalculated to a fluid-free basis

Appendix 3L. Tephra layers in upper Etchegoin Formation, east of Kettleman Hills (2477 collected by K. Loomis, Stanford Univ.; 5.0 ±0.3 Ma), in cores, upper Puente Formation., Los Angeles Basin (3033 collected by Daniel Ponti; *N. rheinholdii* Zone, ~5.2-5.6 Ma), and freshwater ash, Wildcat Group, Humboldt Co. (collected by S.H. Morrison; average of 2 dates, 5.2 ±0.2 Ma K-Ar on volcanic glass).

[Mean compositions of sample groups, bold, are grouped with the closest chemical match, below. All numbers are percentage by weight]

Tephra Data-base No.	Sample Number	Date	SiO ₂	Al ₂ O ₃	Fe ₂ O ₃	MgO	MnO	CaO	TiO ₂	Na ₂ O	K ₂ O	Total R ¹
2477	DEN HARTOG #3-26-89-7 T217-3	10/23/90	77.03	12.31	1.00	0.16	0.04	0.84	0.17	3.18	5.27	100.00
3033	DJP 930501 16-61 T281-7	6/22/93	77.07	13.07	0.98	0.15	0.04	0.83	0.15	3.48	4.24	100.00
358	SM-ASH-26C, T35-4	-	76.41	12.68	0.97	0.15	0.02	0.84	0.19	3.25	4.50	99.01
359	SM-ASH-27B, T35-3	-	76.44	12.62	0.95	0.15	0.03	0.82	0.18	3.38	4.44	99.01
Mean (4)			76.74	12.67	0.98	0.15	0.03	0.83	0.17	3.32	4.61	99.51
Standard Deviation			0.36	0.31	0.02	0.01	0.01	0.01	0.02	0.13	0.45	0.57

¹ Total oxide weight percent, recalculated to a fluid-free basis

Appendix 4. Sr analysis of the bivalve mollusk *Anadara trilineata* (Conrad) in the supplementary reference section of the Purisima Formation along the coast between Point Santa Cruz and Rio del Mar, northern and eastern Monterey Bay, central California.

[Fossil-shell samples were processed for $^{87}\text{Sr}/^{86}\text{Sr}$ and assigned ages using the look-up table for conversion of $^{87}\text{Sr}/^{86}\text{Sr}$ in marine minerals, Lowess Version 4, the best-fit to the Sr seawater variation curve (Howarth and McArthur, 1997; McArthur and others, 2001). ± 2 = two standard deviation; ND = not determined; ** = NA]

Sample No.-	$^{87}\text{Sr}/^{86}\text{Sr}\pm 2\sigma$	Age (Ma)	2 σ min age (Ma)	2 σ max age (Ma)	Sr (ppm)	Mn	Sr/Mn molar	Fe	Weighted Mean Age
A1	0.708904 \pm 0.000017	9.49	8.43	10.17	1586	65.19	24.32	1974	8.4 \pm 3.4
A2	0.708958 \pm 0.000014	6.87	6.36	7.63	1391	13.71	101.47	1995	8.4 \pm 3.4
A3	0.708917 \pm 0.000019	8.99	7.51	9.29	1493	17.70	84.36	1656	8.4 \pm 3.4
CP32306B-1	0.708934 \pm 0.000027	7.83	7.57	8.45	ND	ND	ND	ND	7.44 \pm 0.88
CP32306B-2	0.708954 \pm 0.000039	7.03	6.90	7.20	ND	ND	ND	ND	7.44 \pm 0.88
CP32306B-3	0.708947 \pm 0.000034	7.29	7.13	7.49	1201	0.45	ND	1628	7.44 \pm 0.88
B1	0.709031 \pm 0.000020	5.16	3.92	5.74	1092	9.65	113.16	1451	5.04 \pm 0.47
B2	0.709047 \pm 0.000017	4.54	2.65	4.68	1783	14.05	126.97	1880	5.04 \pm 0.47
B3	0.709030 \pm 0.000017	5.19	4.36	5.70	1620	8.96	180.92	1831	5.04 \pm 0.47
C1	0.709027 \pm 0.000025	5.28	3.82	5.91	1568	11.04	142.01	1737	4.3 \pm 3.4
C2	0.709064 \pm 0.000014	2.78	2.15	2.99	1455	9.84	147.92	1608	4.3 \pm 3.4
C3	0.709034 \pm 0.000022	5.06	3.31	5.72	1400	9.67	144.80	1671	4.3 \pm 3.4
D1	0.709020 \pm 0.000020	5.49	4.76	5.94	1885	13.22	142.56	1935	5.63 \pm 0.38
D2	0.709005 \pm 0.000023	5.80	5.17	6.25	1422	3.96	359.19	1477	5.63 \pm 0.38
D3	0.709031 \pm 0.000030	5.16	2.81	5.92	2196	5.15	426.30	1781	5.63 \pm 0.38
E1	0.709063 \pm 0.000026	2.84	1.77	5.05	1555	8.96	173.60	1660	2.83 \pm 0.90
E2	0.709069 \pm 0.000024	2.54	1.67	4.77	1298	14.86	87.38	1578	2.83 \pm 0.90
E3	0.709060 \pm 0.000024	3.14	1.94	5.08	1288	15.88	81.11	1650	2.83 \pm 0.90
CP32306A-1	0.709051 \pm 0.000037	4.23	3.92	4.47	ND	ND	ND	ND	4.0 \pm 2.7
CP32306A-2	0.709062 \pm 0.000027	2.93	2.76	3.23	ND	ND	ND	ND	4.0 \pm 2.7
CP32306A-3	0.709036 \pm 0.000032	4.99	4.91	5.08	ND	ND	ND	ND	4.0 \pm 2.7
EN-1	0.710174 \pm 0.000014	ND	**	**	1201	0.45	2666.91	1628	-
SRM987	0.710243 \pm 0.000018	ND	**	**	**	**	**	**	-