

RAK-2

NKS/RAK-2(95)TR-C1



Description of the Prototype Fast Reactor at Dounreay

S. E. Jensen**P. L. Ølgaard****Risø National Laboratory
DK-4000 Roskilde, Denmark****December 1995**

Abstract

The Prototype Fast Reactor (PFR) at Dounreay, UK, started operation in 1975 and was closed down in 1994. The present report contains a description of the PFR nuclear power plant, based on information available in literature and on information supplied during a visit to the plant. The report covers a description of the site and plant arrangement, the buildings and structures, the reactor core and other vessel internals, the control system, the main cooling system, the decay heat removal system, the emergency core cooling system, the containment system, the steam and power conversion system, the fuel handling system, plant safety features, the control and instrumentation systems and the sodium purification systems.

The report was prepared as part of the NKS RAK-2 programme.

NKS/RAK-2(96)TR-C1
ISBN 87-550-2265-0

Graphic Service, Risø, 1996

The report can be obtained from:
NKS Secretariat
P.O.Box 49
DK-4000 Roskilde
Denmark

Phone: +45 46 77 40 45
Fax: +45 46 35 92 73
<http://www.risoe.dk/nks>
e-mail: annette.lemmens@risoe.dk

List of Contents

	Page
1. INTRODUCTION	1
1.1. The Dounreay Nuclear Power Development Establishment	1
2. SUMMARY OF DESIGN DATA	2
5. TECHNICAL DESCRIPTION	5
5.1. Site and Plant Arrangement	5
5.2. Buildings and Structures	7
5.3. Reactor Core and other Vessel Internals	9
5.4. Reactivity Control System	14
5.5. Reactor Main Cooling System	16
5.5.1. System Information	16
5.5.2. Reactor Vessel and Primary Cooling System	18
5.5.3. Secondary Cooling System	20
5.5.4. Reactor Coolant Pumps	20
5.5.5. Steam Generators	23
5.5.6. Sodium-Water Interaction in Steam Generators	25
5.6. Decay Heat Removal System	26
5.7. Emergency Core Cooling System	26
5.8. Containment System	30
5.9. Steam and Power Conversion System	32
5.10. Fuel and Component Handling and Storage Systems	32
5.11. Safety Features	34
5.12. Control and Instrumentation Systems	37
5.13. Sodium Purification System	38
5.14. Electrical Power System	39
6. References	39

1. INTRODUCTION

1.1. The Dounreay Nuclear Power Development Establishment

The Dounreay Nuclear Power Development Establishment is one of the research centers of the UK Atomic Energy Authority. It is situated at the northern coast of Scotland in Caithness, about 10 km west of the town of Thurso (cf. fig. 1.1). It was established in 1955.



Fig. 1.1. Map of northern Scotland with Dounreay marked by arrow.

Dounreay has been the principal center for the British development of fast reactors. Two fast power reactors have been built at Dounreay. Firstly the Dounreay Fast Reactor (DFR) with an electric power of 15 MW (60 MW_e) which started operation in 1960 and in 1962 became the first fast reactor power plant to supply electricity to a national grid. The DFR was closed down in 1977. In 1975 the second fast reactor, the Prototype Fast Reactor (PFR) was connected to the grid. It had an electric power of 250 MW. It was closed down in 1994.

In addition to the two fast reactor power plants a fuel reprocessing plant to process fast reactor fuel was built at Dounreay. The plant has also been used to reprocess highly enriched fuel from research reactors.

In addition to the fast reactor facilities a research reactor, the Dounreay Materials Testing Reactor, a heavy water reactor of 10 MW, was commissioned in 1958 and closed down in 1969. Dounreay has also been the center of the British development of submarine propulsion reactors, i.e. pressurized water reactors. Two prototype reactors have been built and operated at Dounreay, PWR-1 and PWR2. These have been used for testing the plants and their components as well as new fuel loadings. In 1984 PWR-1 was closed down and converted to a full-size test rig where loss-of-coolant accidents could be tested. The tests lasted for 4 years. The PWR2-facility, called Shore Test Facility (STF) is provided with the same reactor plant as the Vanguard class submarines. It is a new, all British design.

2. SUMMARY OF DESIGN DATA

Below a summary of design data is presented. It should be pointed out that the data have been obtained from various sources and are for that reason not necessarily consistent. Where significantly different values have been found the newest is given first and the older afterwards in parenthesis.

Power

Thermal power:	630 MW _t
Gross electric power:	250 MW _e
Net electric power:	235 MW _e
Gross efficiency:	39.7%
Net efficiency:	37.3%

Core

Core height:	0.915 m
Core diameter:	1.47 m
Thickness of top axial blanket:	0.45 (0.102) m
Thickness of bottom axial blanket:	0.457 m
Outer diameter of radial blanket:	1.84 m
Fuel inventory:	4.1 t
PuO ₂ inventory:	0.9 (1.1) t
UO ₂ inventory:	3.2 t
Number of fuel assemblies:	78
Number of elements in inner zone:	28 (31, 30)
Number of elements in outer zone:	44 (47, 48)
Specific power:	230 kW/kg Pu+U
Average core power density:	380 kW/l

Fuel Assemblies

Fuel material:	PuO ₂ +UO ₂
Average fuel "enrichment":	25 wt% Pu
Inner core zone "enrichment":	23.5 (22) wt% Pu
Outer core zone "enrichment":	32.3 (28.5) wt% Pu
Number of rods per assembly:	325
Fuel pellet diameter:	5 mm
Active length of rods:	0.915 m
Total length of rods:	2.25 m
Cladding material:	20% CWM 316
Cladding thickness:	0.381 mm
Outer cladding diameter:	5.84 (5.58) mm
Average burn-up:	75 000 MW _t d/t Pu+U
Fuel rod lattice type:	Triangular
Outer shape of assembly:	Hexagonal

Length across shroud:	142 mm
Shroud material:	Stainless steel
Assembly lattice type:	Triangular
Assembly lattice pitch:	144.8 mm
Total assembly length:	3.81 m
Maximum fuel rating:	420 W/cm fuel rod
Average fuel rating:	259 W/cm fuel rod

Reflector

Number of radial breeder assemblies:	51
Number of reflector assemblies:	81

Control

Number of control rod positions:	5
Number of shut-off rod positions:	6
Number of safety rod positions:	1

Reactor Vessel

Vessel diameter:	13.2 m
Inside vessel diameter:	12.24 m
Vessel depth:	15.2 m
Wall thickness:	12.7 mm
Vessel material:	Stainless steel

Primary Circuit

Number of cooling loops:	3
Number of primary pumps:	3
Pump head:	8.22 kg/cm ²
Coolant:	Na
Mass flow:	3.3 (2.92) t/s
Flow velocity:	6 m/s
Core inlet temperature:	414 (400) °C
Core outlet temperature:	562°C
Max cladding temperature;	700°C
Outlet pressure:	6.8 kg/cm ²
Number of steam generators:	3 groups
Mass of Na in reactor tank (prim. cir.):	919 (905) t

Secondary Circuit

Number of secondary pumps:	3
Pump head:	4.50 kg/cm ²
Steam generator inlet temperature:	532 (540) °C
Steam generator outlet temperature:	370 (360) °C
Mass of Na in secondary circuit:	226 (222) t

Turbine Generator

Number of turbo-generators:	1
HP turbine inlet temperature:	538 (516) °C
HP turbine inlet pressure:	161.7 (159) kg/cm ²
HP turbine steam flow:	237 (250) kg/s
Reheat steam pressure at IP turbine:	27.4 kg/cm ²
Steam mass flow:	854 t/hr
Boiler feed water temperature:	288°C
Condenser sea water inlet temperature:	8.9 °C
Condenser sea water outlet temperature:	20°C
Generator rating:	250 MW _e
Revolutions per minute:	3000

5. TECHNICAL DESCRIPTION**5.1. Site and Plant Arrangement**

The site of the Dounreay Establishment is as mentioned in section 1 situated at the northern coast of Scotland. The area around the site is flat with the rock close to the surface. At the end of World War 2 an RAF airfield was built at the site.

The plant arrangement is shown in fig. 5.1.1. Most of the plant is situated in one large building complex, but the sodium store and the seawater pumps for the condenser cooling system are placed in separate buildings.

The main building complex contains the reactor, the steam generators, the turbo-generator hall, the control room and a facility with shielded caves for partly dismantling and initial examination of the irradiated fuel assemblies. The reason for the

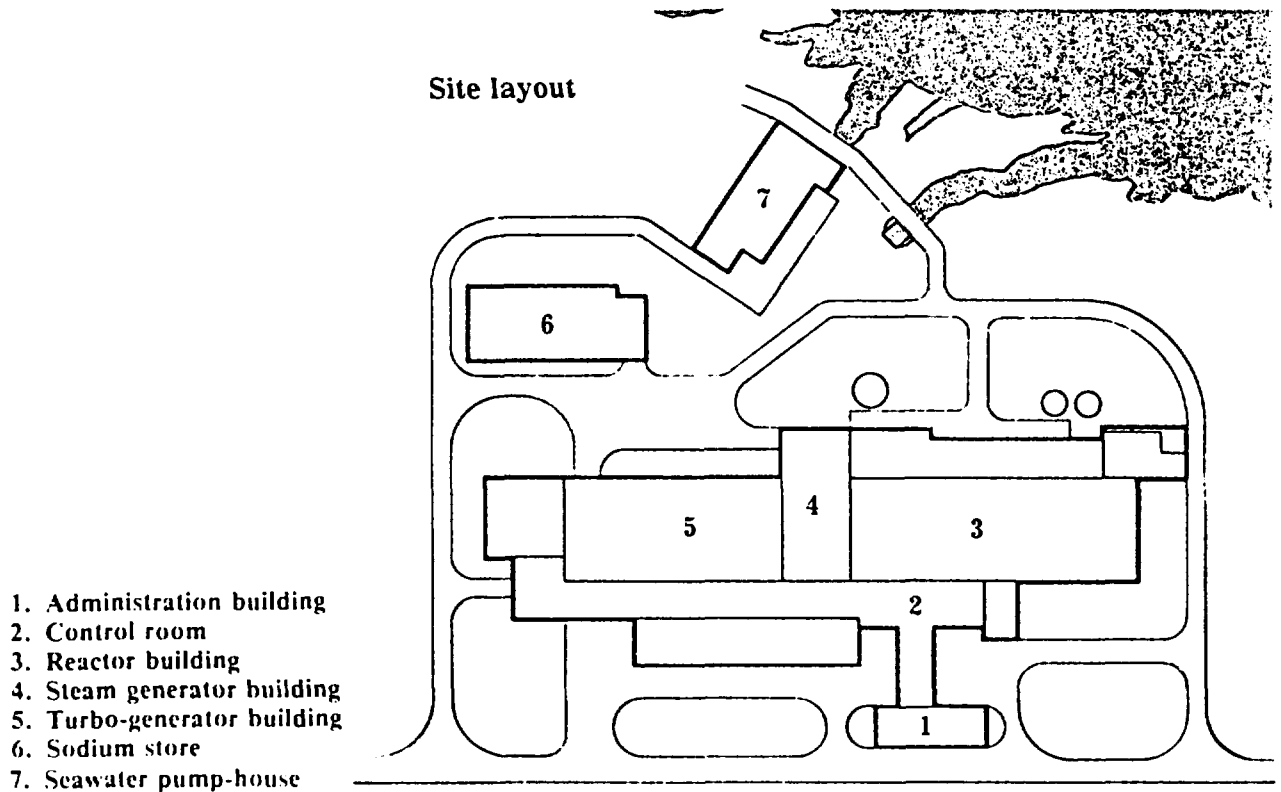

Fig. 5.1.1. Plant arrangement of the Prototype Fast Reactor

shielded caves is that the one of the major objectives of the PFR was to test various designs of fuel assemblies. Also a number of auxiliary plants are situated in the main building. The lay-out of this building is shown in fig. 5.1.2.

The reactor, steam generators and turbo-generator are placed as closely together as possible to minimize pipe and cable runs and simplify staffing during operation.

The reactor is of the so-called pool type design, i.e. the full primary circuit with reactor, coolant pumps and intermediate heat exchangers submerged in the sodium pool in the reactor vessel (see fig. 5.1.3). The reactor lid or roof structure carries all the components of the primary circuit so that the reactor vessel carries only the weight of the sodium. The use of liquid sodium as the primary and secondary circuit coolant means that the reactor vessel is virtually unpressurized. A slight overpressure is maintained in the gas volume above the sodium to ensure that any gas leakage will be outwards.

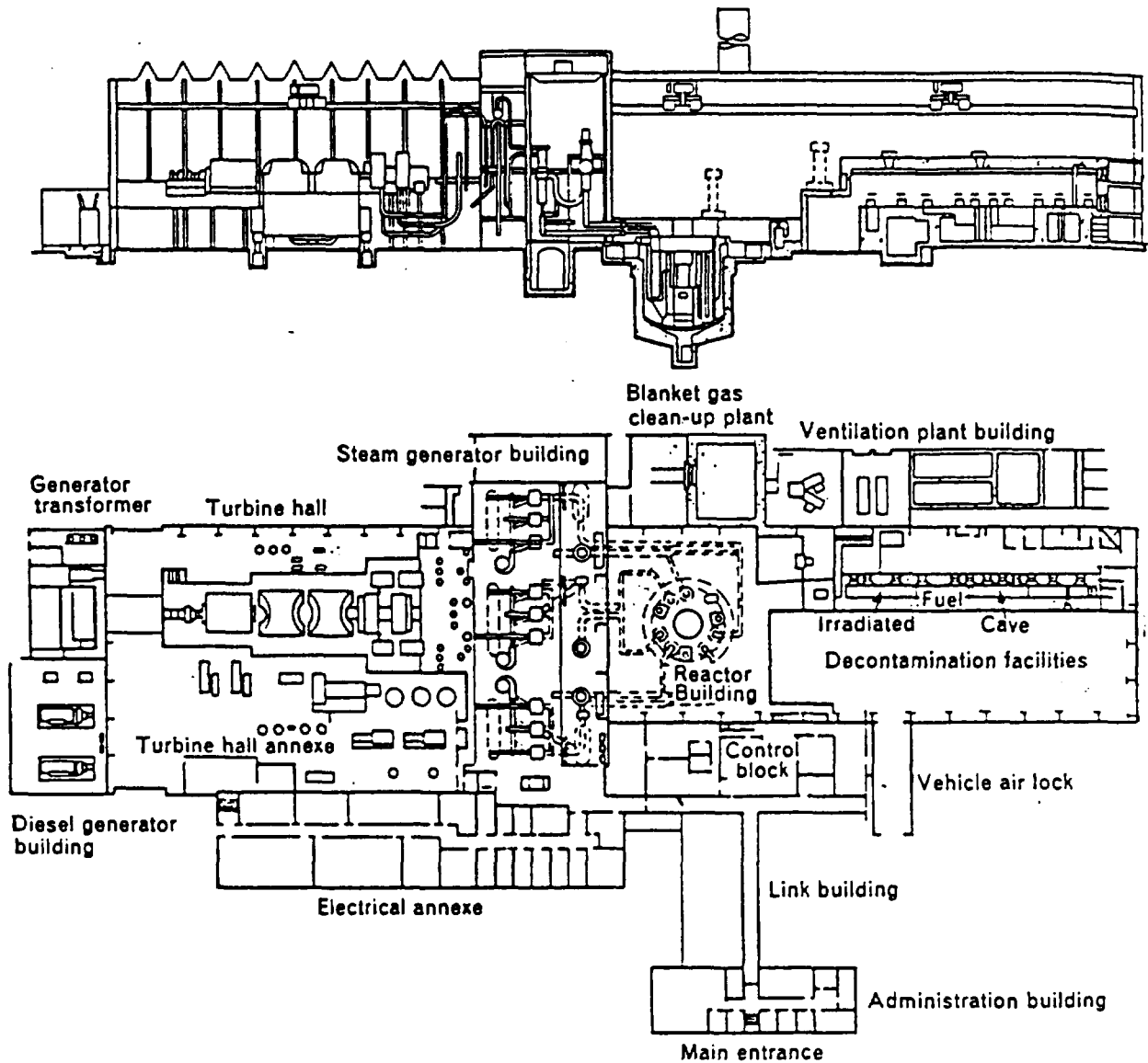

Fig. 5.1.2. Lay-out of PFR main building.

The secondary sodium circuit transports the heat from the intermediate heat exchangers to the steam generators. Here steam is produced and sent to the turbine. This arrangement means that any leak in the steam generator will only affect the non-radioactive sodium of the secondary circuit.

5.2. Buildings and Structures

The reactor is situated in a steel framed building, clad with pre-cast concrete panels to give the desired strength and low

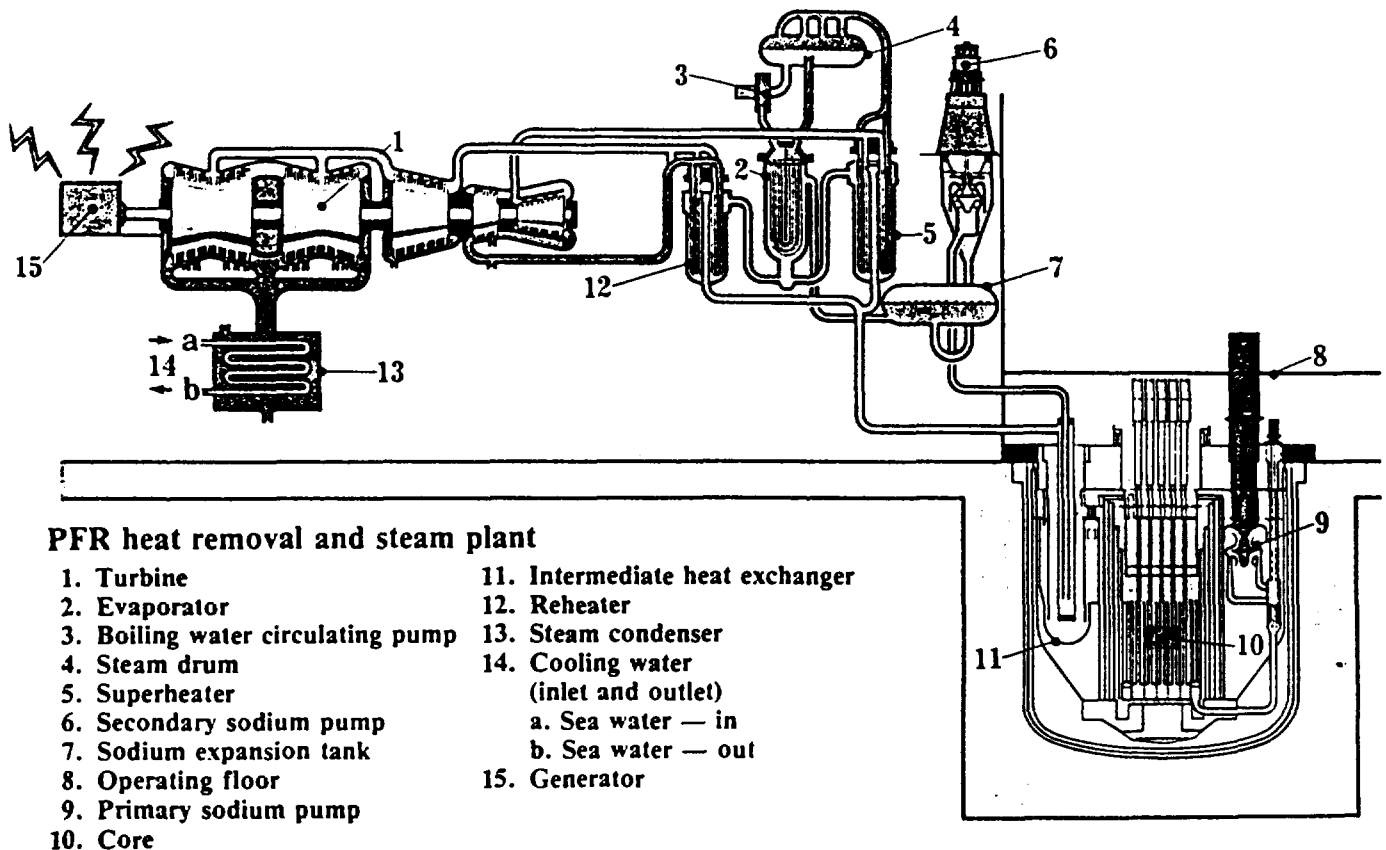

Fig. 5.1.3. The PFR nuclear power plant

leakage rate.

The reactor vessel is placed in a concrete lined vault which rests on the natural rock below ground level. This means that it is only necessary to provide radiation shielding in upwards direction. This shielding consists of the reactor roof structure, consisting of a sufficiently thick concrete plate.

Above the core the roof structure contains a rotating shielding plug, used in connection with refueling. The gas-tight seal between the rotating plug and the roof structure is a cylindrical plate moving in a circular runnel filled with mercury. This arrangement is called a dip-seal. The rotating plug is, due to a number of penetrations, of extra thickness and filled with iron shots and epoxy resin to improve its shielding effectiveness.

5.3. Reactor Core and other Vessel Internals

The reactor core consists of 78 fuel assemblies. It is divided into two zones with different enrichments. The inner zone contains about 28 fuel assemblies with a plutonium/uranium content of 22%/78%. The outer zone contains about 44 assemblies with a plutonium/uranium content of 28.5%/71.5%. The higher plutonium content of the outer zone results in a more uniform power density distribution in radial direction. The total content of plutonium and of uranium in the core is about 1 and 3 tons, respectively.

A cross section of a typical reactor core loading is shown in fig. 5.3.1. At the center there is a guide tube for instru-

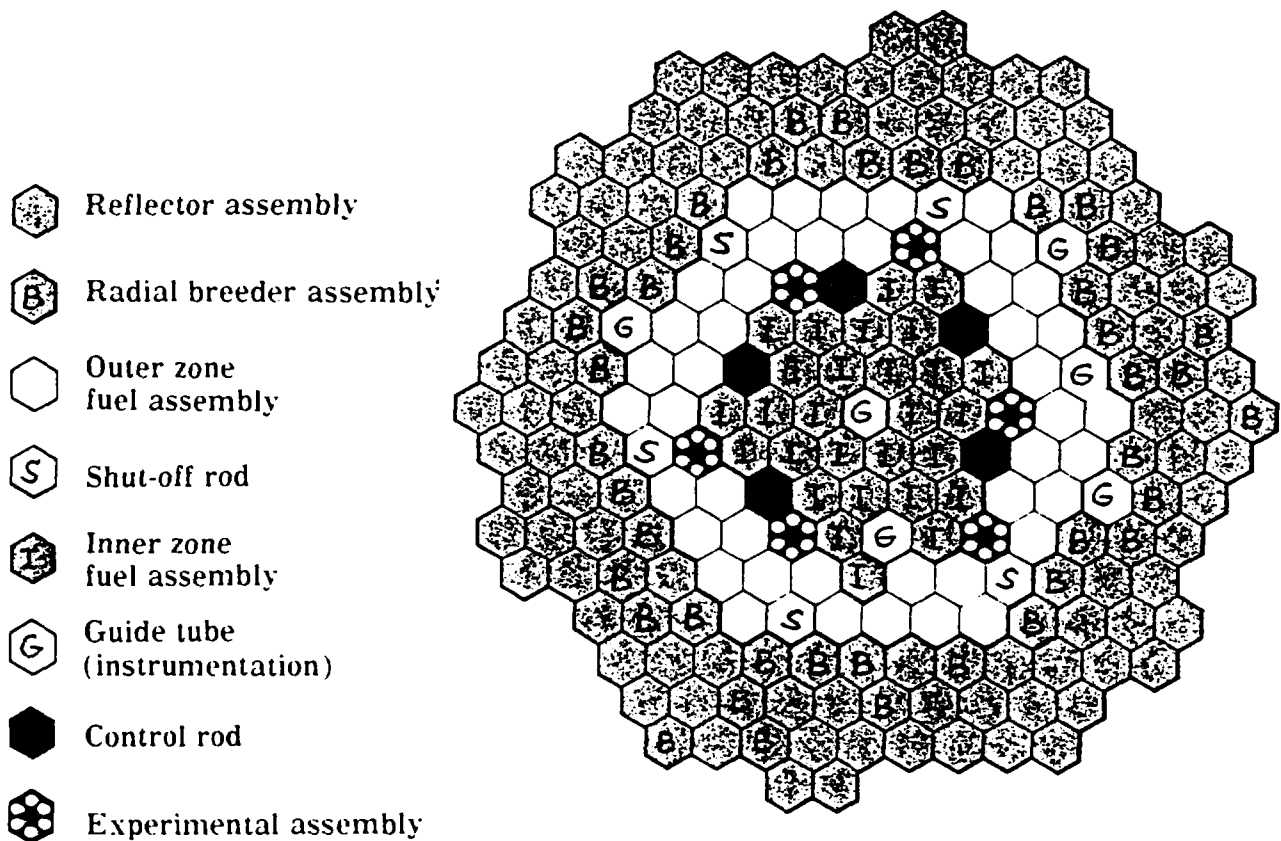

Fig. 5.3.1. Typical core lay-out for PFR.

mentation, and this tube is surrounded by the inner zone fuel assemblies. Next comes the outer zone fuel assemblies. At the interface between the two zones 5 control rods and 6 experimental

assemblies are placed. Additional instrumentation guide tubes exist in various positions of the reactor. Outside the outer zone comes the radial breeder assemblies and finally the reflector assemblies. 5 shut-off rods are placed at the interface between the outer core zone and the radial breeder assemblies.

The standard fuel element is 3.81 m long. At the outside it is provided with a hexagonal shroud (wrapper) with a distance of 142 mm across the flats. It contains 325 fuel rods, each with an outer diameter of 5.84 mm and about 2.25 m long. The fuel material is $(\text{Pu}+\text{U})\text{O}_2$ -pellets and the cladding a stainless steel alloy. The cladding thickness is 0.381 mm. The rods are arranged in a triangular lattice. The rods are at intervals supported by honeycomb grids. The active length of the fuel pins, i.e. the plutonium containing length, is 0.915 m.

Above and below the active length the fuel rods contain a top and bottom blanket section of depleted UO_2 -pellets, and below the bottom blanket section the rods are provided with a 1190 mm long fission gas plenum to limit the pressure build-up inside the cladding tubes. Above the top blanket section of the fuel rods and inside the hexagonal shroud a cluster of 19 shorter rods containing depleted UO_2 -pellets is situated. This cluster is part of the top blanket; the rods which have a diameter of 19 mm, are provided with heavy fins which swirl the outlet coolant to mix it before a coolant sample is taken out of the reactor to detect any failed fuel pin. This detection system is based on a measurement of delayed neutrons; signals from the individual assemblies and from the bulk coolant are provided. The detection system will automatical initiate a reactor shut-down if a serious fuel failure is detected on a two-out-of-three basis. At the top the assemblies are provided with a gag and a circular handling head.

At the bottom the fuel assembly is provided with a spike assembly and a inlet filter. An assembly is shown in fig. 5.3.2.

Initially the burn-up target for the PFR fuel assemblies was the fissioning of 7.5% of the heavy nuclei of the fuel (corresponding to 62000 MWd/t), but this target has gradually been surpassed by design improvements. Fuel irradiation in PFR

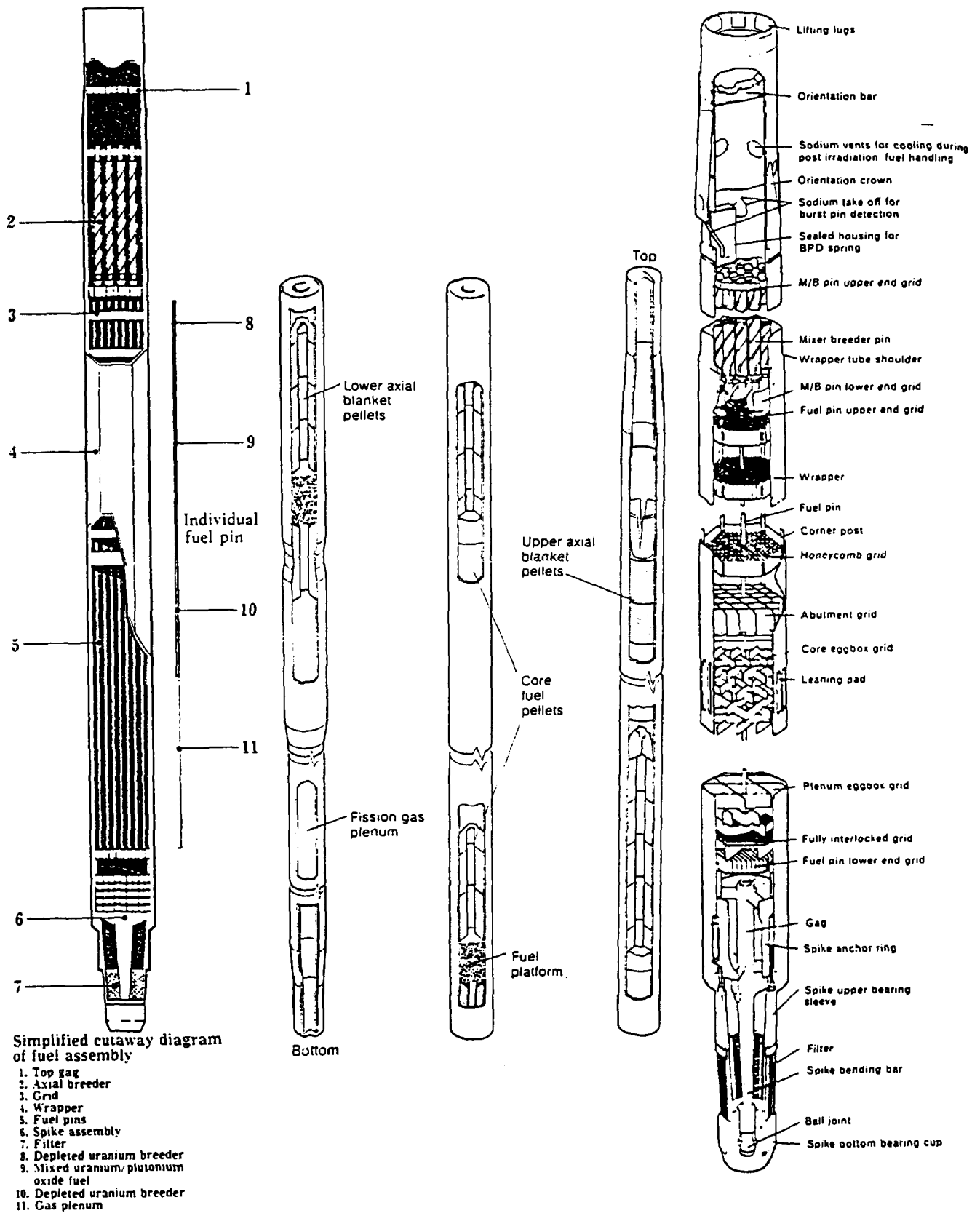

Fig. 5.3.2. PFR fuel assembly and fuel pin.

has proved that fissioning of 15% of the heavy nuclei can be achieved and 20% (168000 MWD/t) seems within reach. Some 93000 fuel pins have been irradiated in PFR with only a few pin failures.

Various cladding materials have been studied, e.g. advanced optimized austenitic steels, ferritic steels and Nimonic alloys. The best results were obtained with Nimonic PE16 cladding.

The plutonium enrichment and the isotopic composition of plutonium of the fuel assemblies varies with time. In fig. 5.3.3.

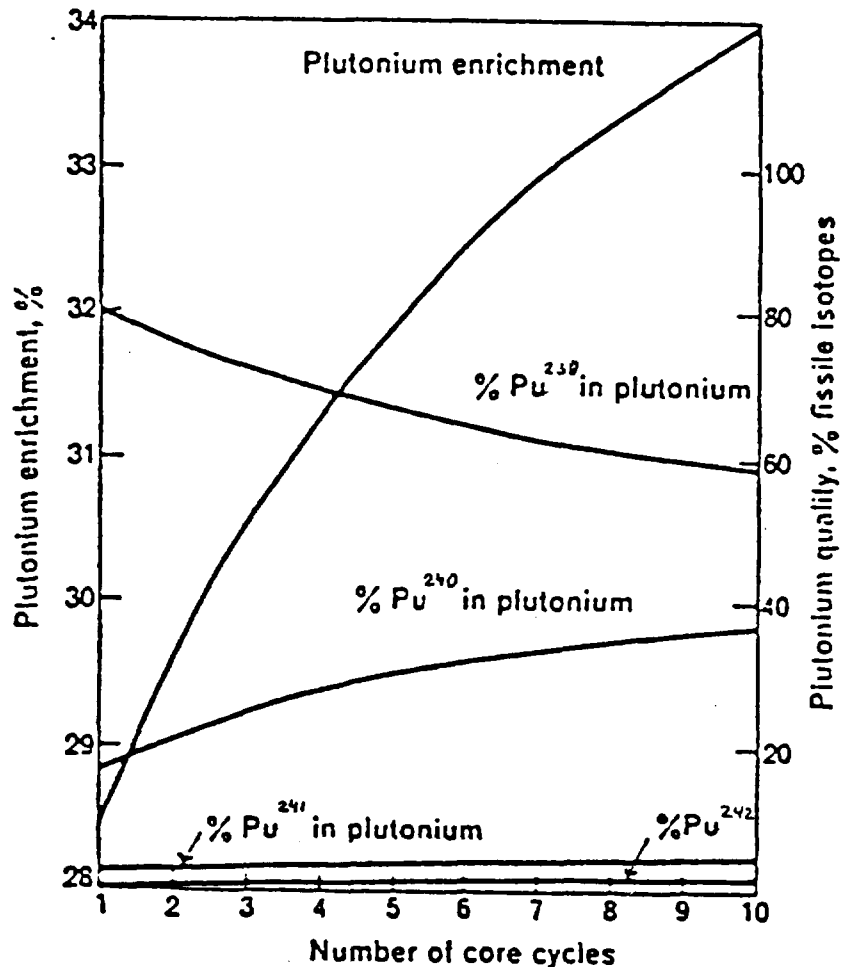

Fig. 5.3.3. PFR core plutonium enrichment versus core cycles.

this variation is shown for outer zone assemblies. It is seen from fig. 5.3.3. that the enrichment increases with the number of core cycles, but the content of ^{239}Pu decreases somewhat while the content of ^{240}Pu increases and so does that of ^{241}Pu and ^{242}Pu .

The radial breeder assemblies are externally identical to

the fuel assemblies. The breeder assemblies contain 85 wire-wrapped rods with a diameter of 13.5 mm. These rods are depleted UO_2 -rods, clad by stainless steel. They are also provided with a fission gas plenum below the UO_2 -section. The breeder assemblies were initially designed for fissioning of 1% of the heavy nuclides (8000 MWd/t), but the highest burn-up achieved was 3% of the heavy nuclides or 25000 MWd/t.

The reflector assemblies are filled with steel rods which serve to reduce the neutron leakage out of the reactor and thereby increase the breeding ratio.

It should be noticed that the PFR served as a test bed for fuel assembly development, and therefore the fuel loading varied to accommodate the experimental needs.

The fuel assemblies are installed in the core in groups of six around a leaning post which may contain a control rod or a guide tube. By use of an offset mechanism at the grid plate below the fuel assemblies the assembly wrappers are forced against the leaning post. This construction prevents vibrations of the free-standing assemblies.

The reactor core as shown in fig. 5.3.1 is surrounded by a neutron shield consisting of 6 rows of steel tubes filled with graphite. This shield prevents the neutrons from reaching the sodium of the secondary cooling circuit. This means that the sodium of the secondary circuit does not become radioactive.

The sodium coolant flows upwards through the fuel assemblies, and the flow will exert upward thrust on the assemblies. This thrust is balanced by use of a hydraulic hold-down design. No mechanical hold-down design is provided, but fuel instrumentation tubes, suspended from the rotating shield plug, limits any possible rise of the assemblies.

The reactor and shielding arrangement is surrounded by a "reactor jacket" or a steel skirt which extends almost to the bottom of the reactor vessel. The upper part of the jacket carries 3 pairs of intermediate heat exchangers (i.e. 6 IHX). The jacket is clad with quilted stainless steel insulation packs and separates the hot sodium leaving the core from the cooler sodium leaving the intermediate heat exchangers.

5.4. Reactivity Control System

The core is controlled by use of 5 tantalum (Mk I) control rods and 5 boron carbide (Mk II) shut-off rods. Initially the central position of the core was used for a safety rod. The control rods are placed at the interface between the inner and the outer zone. The shut-off rods are placed around the periphery of the outer zone. After operational experience with these two types of control rods had been obtained, it was decided that the tantalum rods should not be further developed, and that future rods for the PFR should be of the boron carbide type.

The control rods are worth between 16 and 17 dollars and the worth of the shut-off rods is 7 dollars. The reactor can not be made critical before all 5 shut-off rods are fully withdrawn from the core. The reactor will be shut down if any 3 of the 10 rods are inserted into the core. A total of 3000 rod drops has been performed and on no occasion did any rod fail to respond as intended. The control rods have a lifetime of 530 equivalent full power days (efpd) and the lifetime of the shut-off rods is 1760 efpd. All rods of either type may not be changed at one time. If all control rods are withdrawn at maximum speed, the reactivity increase will be 2.64 cents/s. The resulting power increase will be stopped either by the power deviation trip or by the core outlet temperature trip. In none of these cases will the maximum cladding temperature exceed 740°C and sodium boiling as well as fuel melting will be avoided by a large margin.

The boron carbide rods contain inside a hexagonal wrapper of PE16 Nimonic alloy a cluster of 19 absorber pins. These pins consist of stainless steel cladding tubes containing cylindrical boron carbide pellets. The cladding tubes are on the inside coated with copper to prevent diffusion of boron from the pellets into the cladding with consequent embrittlement. Helium gas, produced by neutron capture in ^{10}B , is vented into the sodium through a lute tube and plenum at the top of the pins. The pins are cooled by a sodium flow up through the pin cluster. A boron carbide control rod is shown in fig. 5.4.1.

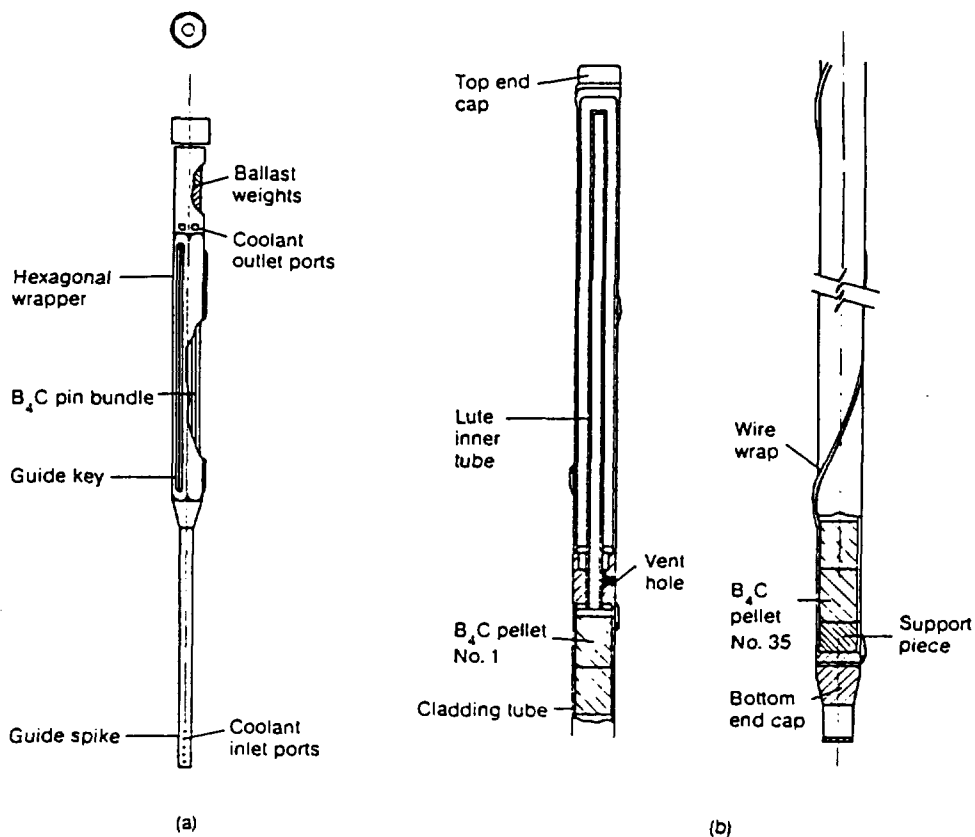

Fig. 5.4.1. PFR Mk II control rod: (a) rod housing (b) pin.

The Mk II boron carbide pins used 20% cold-worked M316 steel cladding tubes of 21.5 mm external diameter and 1 mm wall thickness with a 0.15 mm inside copper lining. The boron carbide pellet stack length is 88 cm and the pellet diameter 19 mm. Later pin designs have different dimensions, but the general design was similar. However, the cladding material was PE16 Nimonic alloy in the later versions. In Mk IV the pins were bottom vented by use of the diving bell principle.

The drive mechanisms for the all absorber rods are situated on and above the rotating shielding plug. Both the rods and the drop-off magnets may be removed for maintenance. The rods are attached to the drive mechanisms by a bayonet connection. This means that the rods can be detached and remain in the core when the rotating shielding plug is moving during refueling. A sweeping arm is used to ensure that all control rods have been disconnected before the rotating plug is moved. The control rods

are moved by screw and nut motors, driven through a reduction gear. The connection between the nut and the absorber rod is arranged by use of a magnetic assembly, so that the rod can be dropped into the core in case of an emergency.

During refueling both the control and the shut-off rods are delatched and remain in the core. The safety rod could remain outside the core during refueling, ready for insertion.

5.5. Reactor Main Cooling System

5.5.1. System Information

The main cooling system consists of the primary sodium circuit, three independent secondary sodium circuits, and three steam generators delivering steam for one turbo generator unit (see fig. 5.5.1).

The main data for the circuits are the following.

Primary and Secondary Sodium Heat Transfer System:

Reactor vessel inside diameter	12.24 m
Temperature at core inlet	400°C
Temperature at core outlet	562°C
Temperature at steam generator inlet	532°C
Temperature at steam generator outlet	370°C
Flow through core and breeder	2923 kg/s
Total flow for three secondary circuits	2923 kg/s
Pump heads, three primary pumps	8.22 kg/cm ²
Pump heads, three secondary pumps	4.50 kg/cm ²
Sodium weight in reactor vessel	905 t
Sodium weight in secondary circuit	222 t

Turbine System:

Steam temperature at HP and IP TSV's	516°C
Steam pressure at HP TSV	161.7 kg/cm ²
Reheat steam pressure at IP TSV	27.4 kg/cm ²

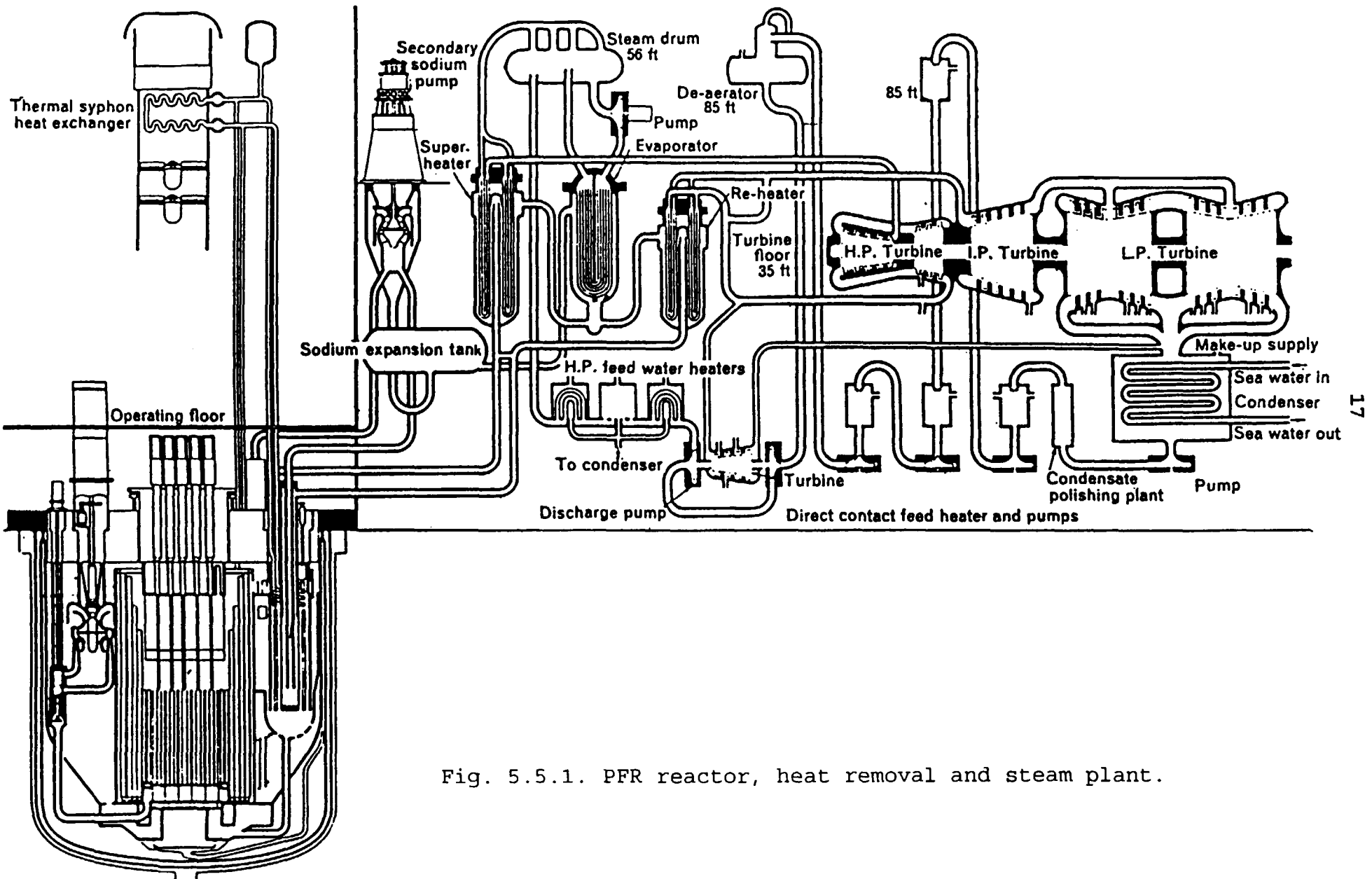

Fig. 5.5.1. PFR reactor, heat removal and steam plant.

Steam flow in HP turbine	249.9 kg/s
Min. steam flow at which full superheat and reheat temps. are maintained	20%
Boiler feed water temperature	288°C
Condenser pressure	25 mm Hg
Condenser sea water temp. inlet	8.9°C
Condenser sea water temp. outlet	20.0°C

TSV is the turbine stop valve. The whole of the primary circuit is contained within the stainless steel vessel (pool tank). The primary circuit is divided into a cold pool and a hot pool, separated by the "reactor jacket".

Three main pumps circulates sodium from the cold pool through the reactor core and the neutron shield to the internal heat exchangers (IHX) where it is cooled to 400°C before returning to the cold pool.

The secondary circuit consists of three independent loops, each comprising two internal heat exchangers (IHX) in the pool vessel, one main pump and one steam generator.

The evaporators and the heat exchangers of the steam generating system are vertically mounted "U"-tube units.

5.5.2 Reactor Vessel and Primary Cooling System

The reactor pool tank is a cylindrical stainless steel vessel, 12.2 m diameter and 15.2 m deep with 12.7 mm wall thickness. It is suspended from the fixed roof structure (see fig. 5.5.2.1). All components inside the core are also suspended from the roof, thus minimizing the stresses on the vessel.

The reactor vessel is surrounded by a safety vessel or a leak jacket, made up of low alloy steel. This leak jacket is also suspended from the roof. The purpose of the jacket is to limit the drop of the liquid metal level in the reactor vessel, following a sodium leak in the vessel.

A major design problem, to limit the thermal stress in the upper part of the vessel, was solved by graduating the thickness of the isolation giving an acceptable axial temperature gradient

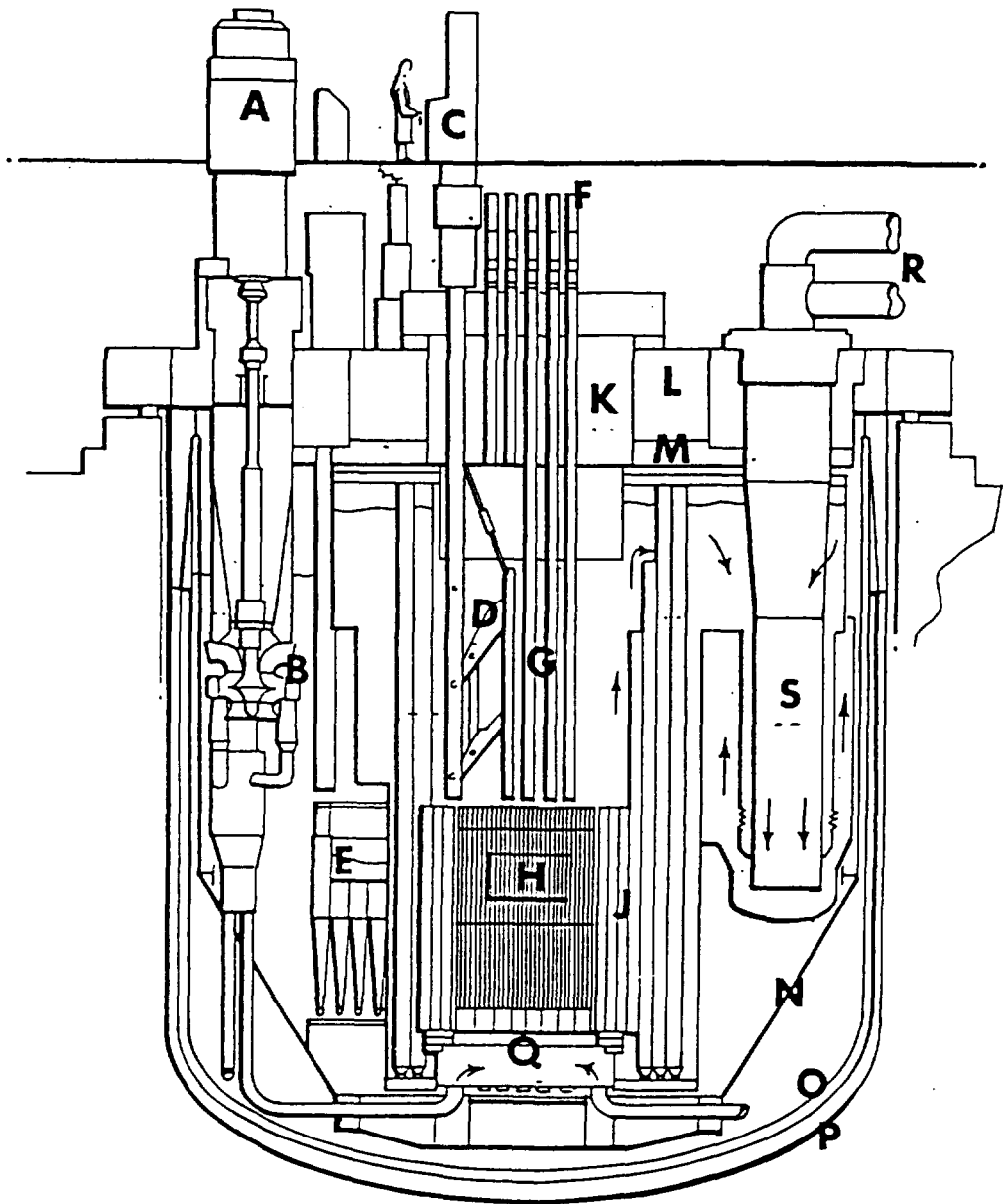

- | | |
|----------------------------|--------------------------------|
| A. Sodium pump motor (3) | K. Rotating shield |
| B. Primary sodium pump (3) | L. Biological shield |
| C. Charge machine console | M. Stainless steel insulation |
| D. Charge machine | N. Diagrid support structure |
| E. Rotor | O. Primary vessel |
| F. Control rod drives | P. Leak jacket and insulation |
| G. Control rods | Q. Diagrid |
| H. Core | R. Secondary sodium pipes |
| J. Neutron shield | S. Intermediate heat exchanger |

Fig. 5.5.2.1. Vertical cross section of PFR reactor vessel.

from the sodium surface to the roof.

The core grid plate, the core and the neutron shield are carried by a cylindrical and downwards conical structure, welded to the roof.

The IHX units (fig. 5.5.2.2) transfer heat from the primary radioactive sodium circuit to the three secondary non-radioactive circuits.

The PFR has 6 IHX units, each designed to transfer 100 MW_t. The IHX units are of the counterflow shell and tube type containing 1540 tubes each. The tube outside diameter is 19 mm, and they are 4.57 m long.

Primary sodium flows through the tubes, and expansion between the tubes and the shell is accommodated by sinusoidal bends on the tubes.

The IHX units are suspended from the reactor roof. Each unit contains a coil for decay heat removal through the NaK circuit (see section 5.7. Emergency Core Cooling System).

5.5.3. Secondary Cooling System

The PFR operates with three secondary sodium cooling loops and a tertiary steam/water system. One secondary system comprises the secondary part of two intermediate heat exchangers (IHX), a secondary coolant pump, an expansion tank, and the primary part of the corresponding evaporator/reheater/superheater (Fig. 5.5.1).

5.5.4. Reactor Coolant Pumps

The primary circuit is provided with three mechanical sodium pumps. These pumps are of a vertical construction with the double inlet type impeller placed at the bottom of the sodium pool.

The main characteristics are:

Flow rate:	84,000 l/min.
Discharge:	8.9 kg/cm ²
Working temperature:	430 °C

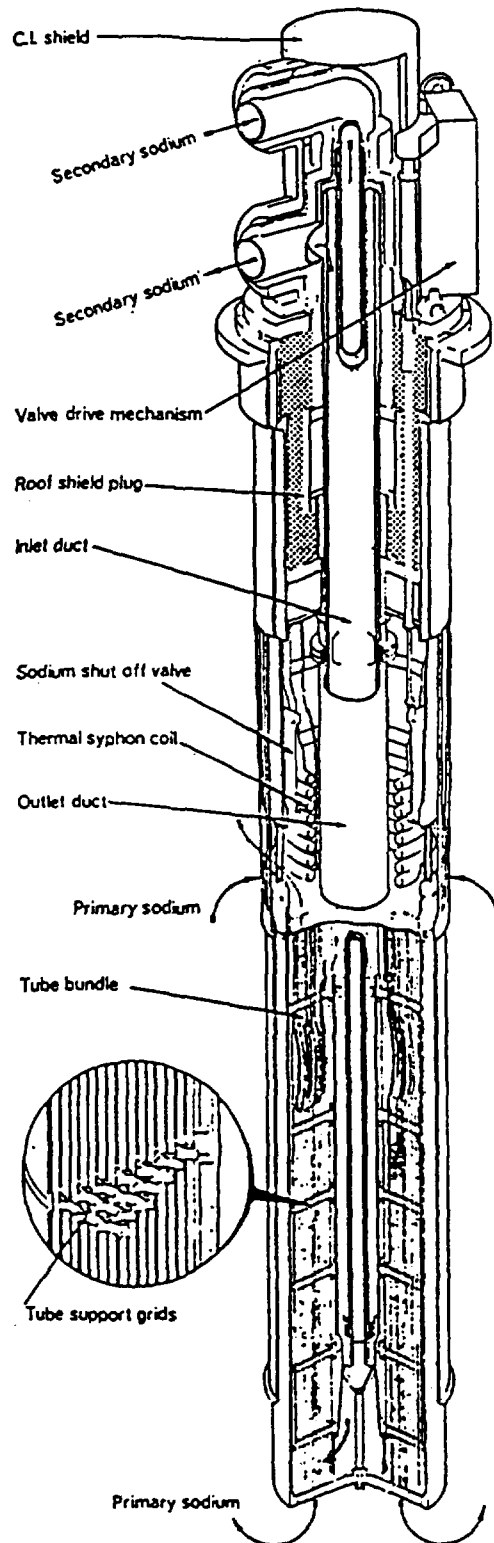

Fig. 5.5.2.2. PFR intermediate heat exchanger.

Speed variation by hydraulic coupling: 5:1

The rotating part of the pumps is supported by a conventional roller bearing at the top of the pump head, and by a sodium lubricated hydrostatic bearing just above the impeller. Sodium is fed to this bearing from the pump discharge casing. The bearing material is stellite 6.

An oil lubricated face seal provide a leak tight barrier between the reactor cover gas (argon) and the atmosphere. At one occasion oil from the seal (and from the roller bearing?) leaked into the sodium pool in a total amount of about 200 l. This incident necessitated a full clean up of the primary circuit.

The pumps are driven by normal squirrel cage induction motors. A speed variation of 5:1 is obtained by hydraulic couplings. Adequate shut-down circulation is provided by running the main pumps with pony-motors.

The pumps are designed with close attention to avoid noise. In designing the pumps special care has been taken to avoid noise from the impeller blades. High frequency noise caused by cavitation can be confused by that produced by boiling sodium, and thus disturb the instrument recordings. By careful shaping of the impeller blades, high frequency noise has been reduced.

The secondary pumps are vertical pumps of the centrifugal type, with a mixed flow impeller delivering sodium at an angle to the pump axis. The coolant flow is straightened in a bowl type diffuser.

The main characteristics are:

Flow rate:	75,000 l/min. (one pump)
Discharge:	4.5 kg/cm ²
Working temperature:	370 °C

The pumps are driven by induction motors. Maximum speed is 960 rev/min. This speed can be reduced by the hydraulic couplings. The pumps are equipped with pony motors for shut down operation.

5.5.5. Steam Generators

The PFR has three independent secondary loops. Each secondary loop is connected to a 200 MW steam generator. The steam generator is the plant component which, next to the reactor, contains the greatest technical innovations. The three secondary loops with steam generators are entirely separated from each other with the exception of common dumping and clean-up facilities.

Fig. 5.5.1 shows one secondary loop, comprising evaporator, reheater, and superheater. Fig. 5.5.5.1 shows the evaporator, reheater, and superheater in some detail.

During the early operation the steam generators, in particular the evaporators, gave rise to leakage problems. The tube/tubeplate weld design could not be stress relieved after fabrication and a number of weld leaks developed. After some tube plugging and attempts of shot peening the problem was solved by bypassing the welds by use of a sleeving technique.

About 1000 welds on each of the 3 evaporators were sleeved.

Similar welds were used in the austenitic stainless steel superheater and reheater units. During the early operation leaks occurred in two superheaters and one reheater unit. The leaks caused stress-corrosion cracking in the tube-plate material. The superheaters were returned to service after repair, but in the case of the reheater the cracking was so severe that the plant was started without it. Because of concern for new leaks - which did not materialize - a new design was developed which eliminated the welds between tube and tube-plate and which used ferritic tube bundles. The first of these units, a reheater, was installed in 1984.

Cracking of welds between the stainless steel plates of the superheaters and reheaters was also experienced. The problem was caused by delayed reheat cracking. It was managed by novel repair methods.

Steam from the superheater enter the High Pressure turbine (H.P.turbine) at 161.7 kg/cm² and 516°C. Outlet steam from the H.P turbine is reheated at 27 kg/cm² to 538°C before entering the

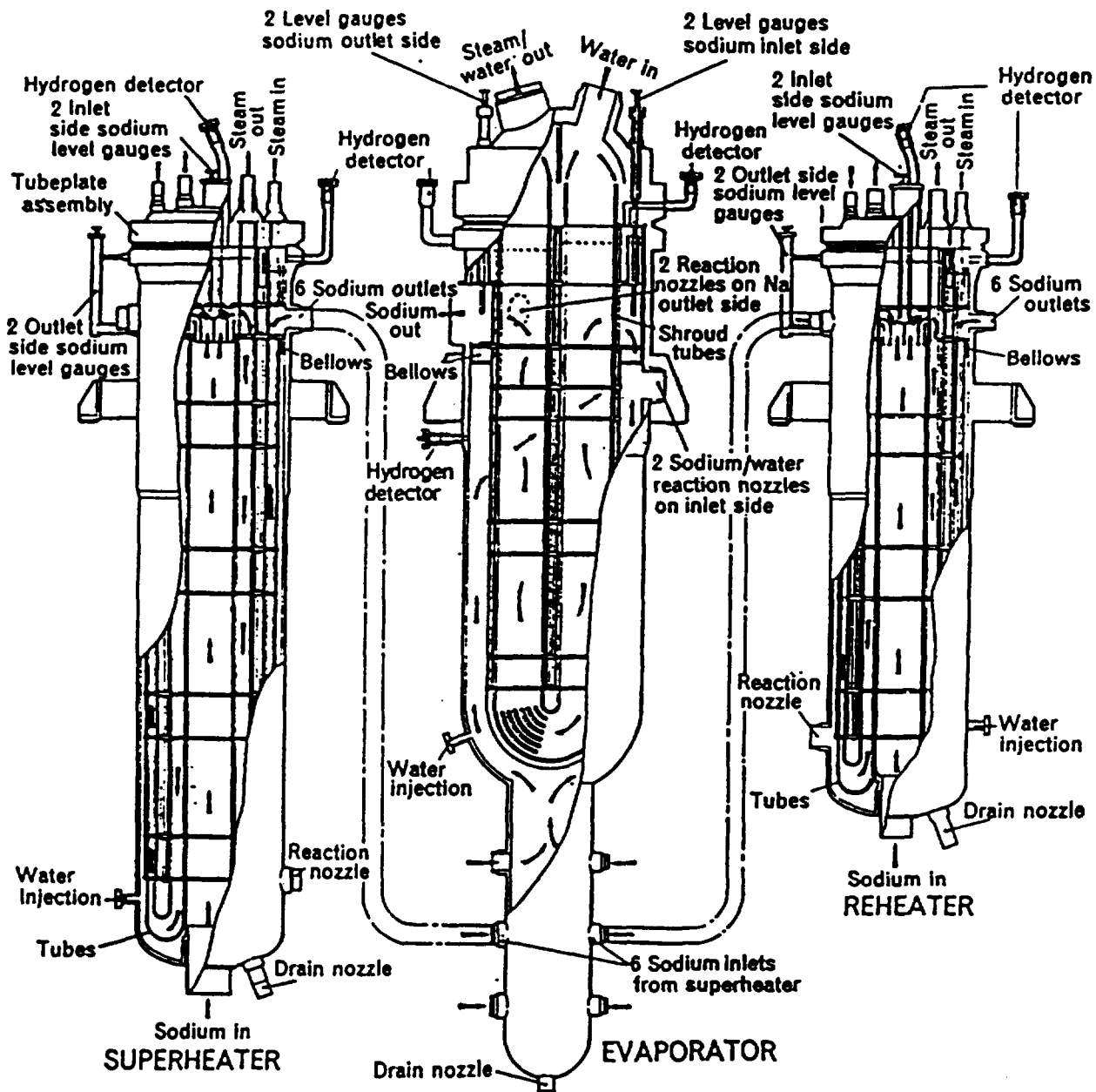

Fig. 5.5.5.1. PFR steam generator heat exchangers.

Intermediate Pressure turbine (I.P.turbine). Steam from the I.P.turbine goes directly to the Low Pressure turbine (L.P.turbine).

All the heat exchangers of the steam generator are vertically mounted shell and "U"-tube units. The evaporator employs parallel flow, while reheater and superheater operate with counter flow. The evaporator tube and tube-plate material is 2.25% Cr, 1% Mo, niobium stabilized steel. The superheater and reheater tube material is 316 type stainless steel

5.5.6. Sodium-Water Interactions in Steam Generators

A severe sodium-water reaction, caused by a tube rupture, results in a pressure increase in the secondary system. This increase will operate relief devices fitted to each unit. These devices consist of nickel membranes, supported by hinged plates. The pressure increase will break the membrane.

Hydrogen detectors fitted to the sodium side of the steam generators as seen in fig. 5.5.5.2 will at a predetermined level isolate both the sodium and the water/steam system from the rest of the plant and also dump the water side. Following such an occurrence the plant is able to restart operation on two steam raising units at reduced power.

It is important to detect a leak in one of the exchangers at a very early state, because instantly after a rupture the following chemical reaction will take place:

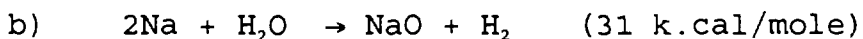
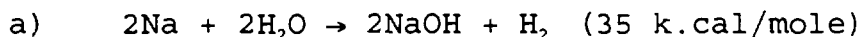

The dominating reaction is a). The reaction products of these reactions, in particular of a) are very corrosive.

The high pressure and temperatures produced by a Na-H₂O-reactions give rise to a pressure chock which breaks the rupture disc after about 10 millisec., and the sodium enters the pressure suppression line on its way to the dump tank.

Until February 1987 steam generator tube failure tests in large sodium rigs seemed to indicate that an initial tube failure

would only propagate to about six neighbouring tubes during the time it takes to stop the accident by depressurization and dumping of the water and sodium reactants. Thus the reactor design basis was limited to this level of a steam generator damage.

In February 1987 a superheater tube failure, due to tube fretting under sodium caused by flow-induced vibrations, led to the failure of 40 tubes, but the large safety margins enabled the plant to survive with no other damage than the tubes themselves. The accident led to a revision of the safety analysis, and it was recommended to replace the tube bundles of the superheater and reheater by an improved design.

The figures 5.5.6.1. to 5.5.6.5 tell the story about the repair techniques for the PFR steam generator exchangers.

To be forewarn of such problems, acoustic monitoring systems have been developed and shown to be effective to detect vibration problems.

5.6. Decay Heat Removal System

The decay heat of the reactor following a shut-down is removed by the main cooling system.

Pony motors on the main pumps take up the drive at a about 10% of full speed to provide adequate circulation in the systems.

The decay heat removal system proved difficult to operate during the transient following a steam plant and turbine trip, and the NaK systems (see section 5.7) became the operationally preferred system for decay heat removal.

5.7. Emergency Core Cooling System

The PFR is as mentioned above a pool type fast breeder reactor. The basic idea of the pool type reactor is that it is very unlikely that a "Loss of Coolant Accident" should happen. There are three reasons for this:

- 1) The whole primary cooling system is submerged in the pool

PFR EVAPORATOR REPAIR SLEEVE

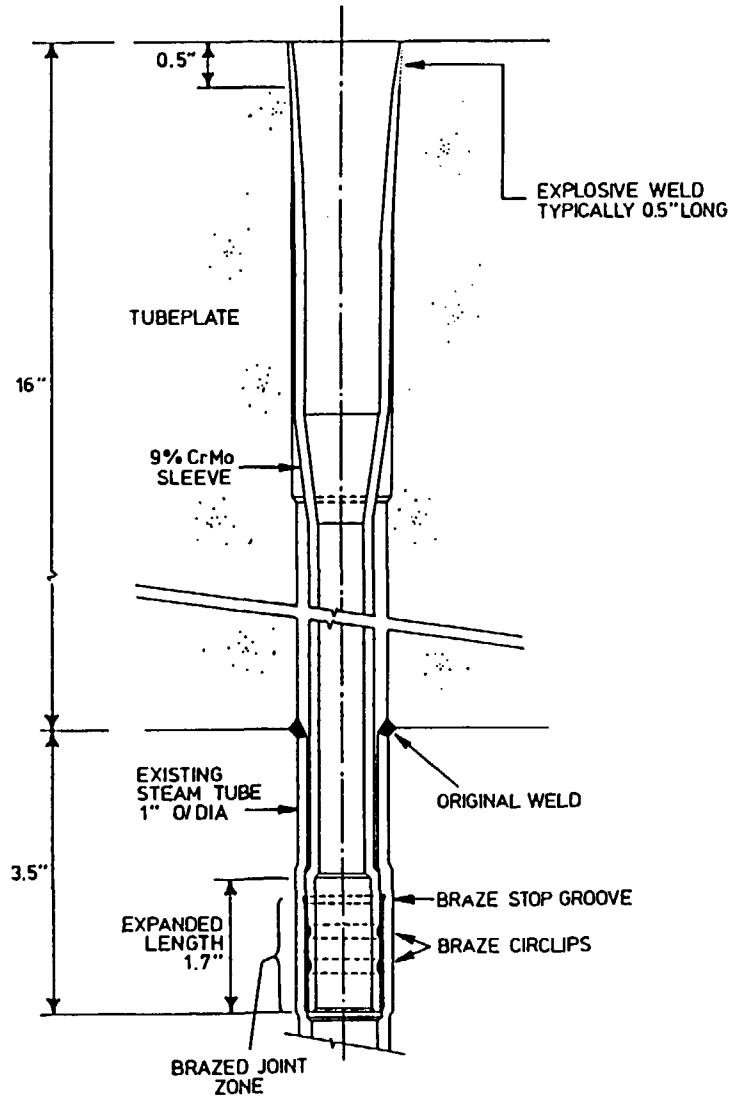
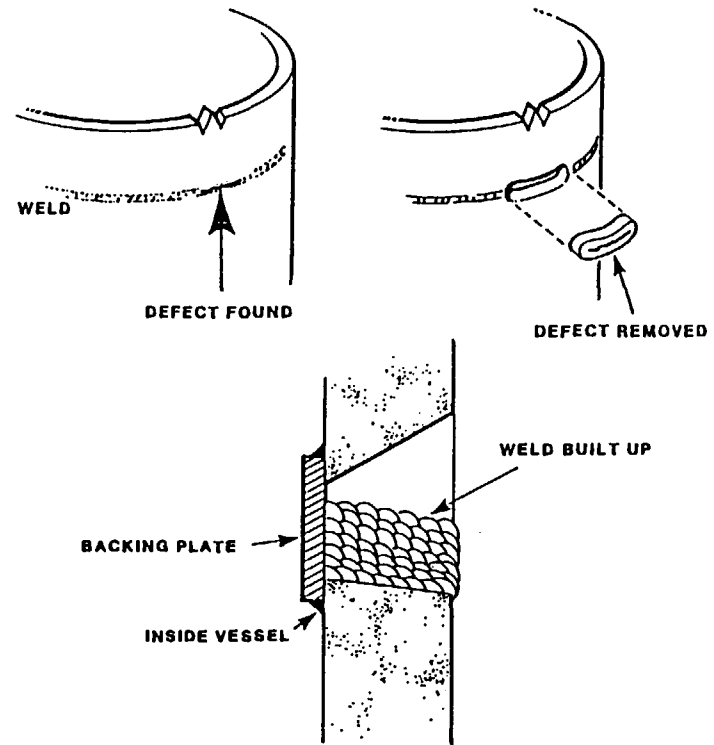

Fig. 5.5.6.1. Evaporator repair sleeve.

**STEAM GENERATOR
Vessel Repair Techniques - 1987**

DEFECT FOUND — Reheater 2 - Leaker
Reheater 1 - Ultrasonic Detection
Superheater 2 - Ultrasonic Detection

PLANT STATE — Tube Bundles removed
Vessels cleaned of sodium
Internal vessel access



FINAL INSPECTION LEVEL — Ultrasonic Examination
Radiography
Dye penetrant test

Fig. 5.5.6.2. Vessel repair 1987.

STEAM GENERATOR
Vessel Repair Technique - 1988

- DEFECT FOUND** - Reheater 1 - Leaker
 Superheater 2 - Ultrasonic Detection
 (grown)
- PLANT STATE** - Tube bundles in vessel
 No internal access to vessel
 Vessels argon padded

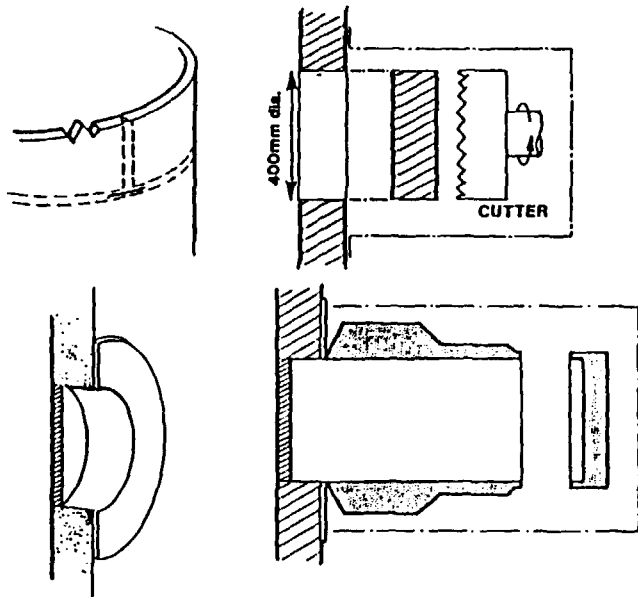

FINAL INSPECTION LEVEL

Full volumetric inspection
 Gamma Radiography
 Dye penetrant test

Fig. 5.5.6.3. Vessel repair 1988 I

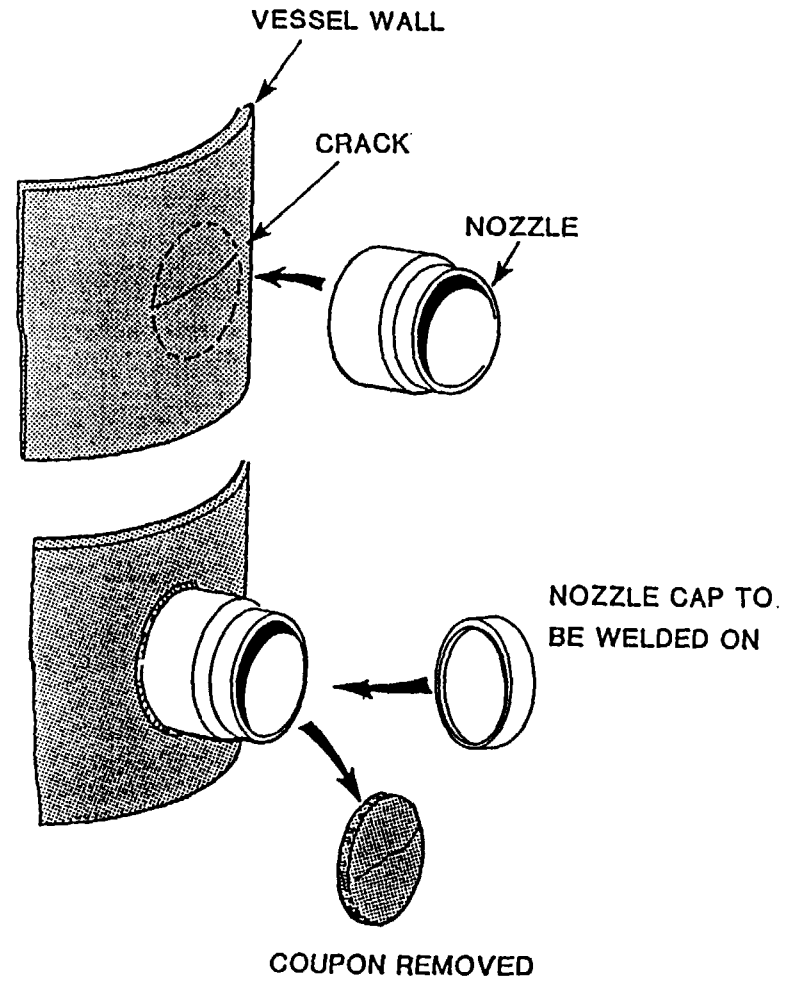

Defect Repair Method

Fig. 5.5.6.4. Vessel repair 1988 II

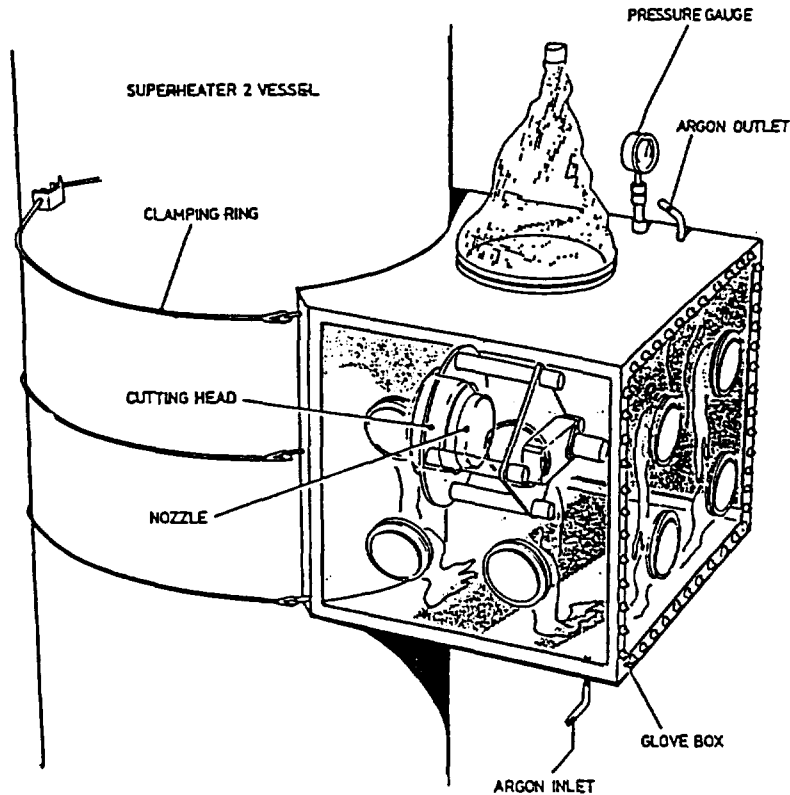

METHOD OF COUPON REMOVAL

Fig. 5.5.6.5. Vessel repair 1988 III

tank. Any leak in the primary system is unable to lower the sodium level in the pool.

- 2) The main pool tank is surrounded by a safety tank, which should guarantee that a "Loss of Coolant Accident" which leads to the uncovering of the core is almost impossible.
- 3) The sodium circuits are not pressurized, and a temperature increase of almost 400°C is possible before boiling takes place.

The large amount of sodium present in a large pool type reactor like PFR is arranged to provide natural circulation by convection, and the heat capacity guarantees that even without any decay heat removal system or emerging cooling system available,

it takes many hours before the sodium temperature in the pool and in the core approaches the boiling point of sodium.

The PFR has four independent residual heat removal systems, which can be divided into two groups.

The first group involves a thermal syphon coil included in every intermediate heat exchanger unit. These coils are part of three independent NaK loops, releasing the residual heat to the atmosphere via NaK/air heat exchangers, and by natural convection. The NaK loops are designed to maintain safe temperatures within the primary circuit in the event of power supply failure. The nominal decay heat removal of this system from the reactor is 5 MW. The heat transfer capability can be increased by operating fans. (See fig. 5.5.1). The freezing point of the NaK mixture used at the PFR is about -11°C . This is quite sufficient for the location at the Dounreay site, where temperature below 0°C is rather infrequent.

The second group is based on flow of atmospheric air by natural circulation around the safety vessel. This flow will cool the vessel before leaving the reactor vault through the annular channel around the upper part of the tank (see fig. 5.7.1.). The inlet channel to the vault comprises a water cooled heat exchanger, called the cold finger. It is not known whether the capacity of the natural circulation air cooling system (with - or without the cold finger) is sufficient to serve as the only emergency core cooling system.

Studies in the U.S.A. have shown that natural convection of air through the spacing between reactor safety vessel and reactor pit is sufficient to remove the decay heat from a pool type sodium cooled fast breeder reactor.

5.8. Containment Systems

Unlike light water reactors the PFR primary circuit and the reactor vessel does not contain hot water under high pressure. Further in case of pump failure natural circulation of the sodium together with the significant heat capacity of the sodium pool and auxiliary heat removal systems will ensure adequate cooling

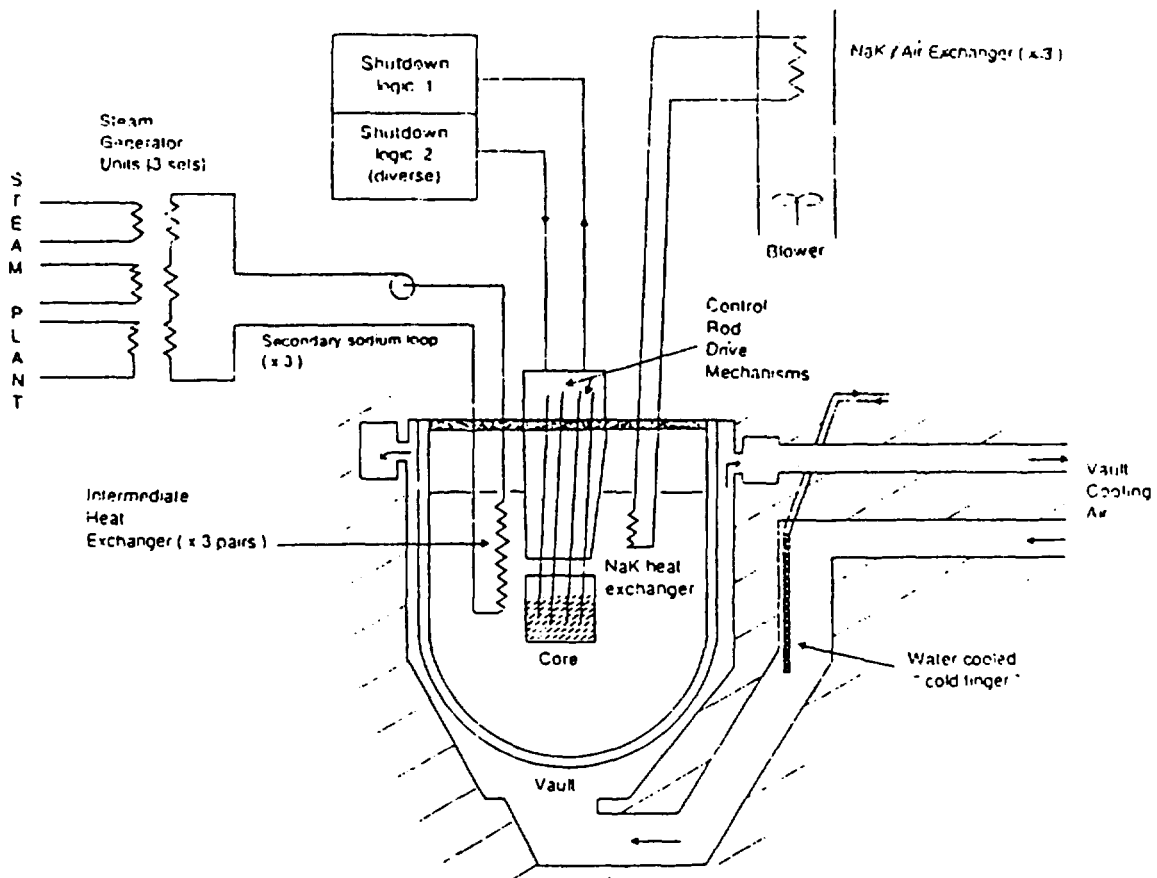

Fig. 5.7.1. PFR shutdown and heat removal systems

of the reactor.

This means that the requirements of the reactor containment are very different from and less strict than those of light water reactors. For example any leak in the primary system will not result in a high pressure build-up in the reactor building.

The reactor tank with the primary cooling system, the 6 intermediate heat exchangers and most of the 3 secondary cooling systems (including the 3 secondary cooling pumps) are placed in the reactor building. The steam generators, one for each secondary circuit, are placed in the steam generator building next to, but outside the reactor building. Thus there are no high pressure cooling system inside the reactor building.

The PFR plant comprises 2 barriers between the core and the surroundings. The first barrier is the reactor vessel and the leak jacket together with the reactor roof structure with the

liquid metal seals. The second barrier is the reactor building.

The primary containment of the reactor system consists of the stainless steel reactor vessel which has no penetrations below the level of the liquid sodium. It is enclosed in a close-fitting thermally insulated outer tank, and both tanks are suspended from the reactor roof.

The secondary containment is the reactor building which is designed to contain the pressure and activity release which might result from a reactor or a fuel handling accident. The building is a steel structure clad with concrete panels, sealed to each other and to the frame by polysulphite. It is designed to withstand an internal pressure of 20" water gauge. The leak rate is below 50% per day at 4" water gauge.

The associated ventilation system, which in the event of an incident automatically takes the air of the reactor hall through a clean up plant, keeps the pressure in the building below the external pressure. This prevents the release of unfiltered air.

5.9. Steam and Power Conversion Systems

The PFR operates with one turbine generator, comprising a high pressure turbine, an intermediate pressure turbine and two low pressure turbines (fig. 5.5.1).

The turbine generator is in line with the reactor building to avoid the danger of turbine missiles hitting it directly.

The high pressure turbine works with superheated steam at a pressure of 161 kg/cm and temperature of 516°C. The medium pressure turbine works with reheated steam at 27.4 kg/cm². The pressure and temperature before the low pressure turbines are not known.

The generator is a 2 pole 3000 rev./min. hydrogen-water cooled machine. It is 3 phase machine with a main voltage (phase to phase) of 17,000 volt and a current rating of 10,000 A.

5.10. Fuel and Component Handling and Storage Systems

All refueling is performed when the reactor is shut-down. It is

done by use of the rotating shield plug above the core and a rod-shaped refueling machine which penetrates from the plug down into the reactor vessel close to the top of the fuel assemblies. Fixed to the machine by means of movable arms is a vertical chute (see fig 5.10.1.). By rotation of the plug and movement of the chute

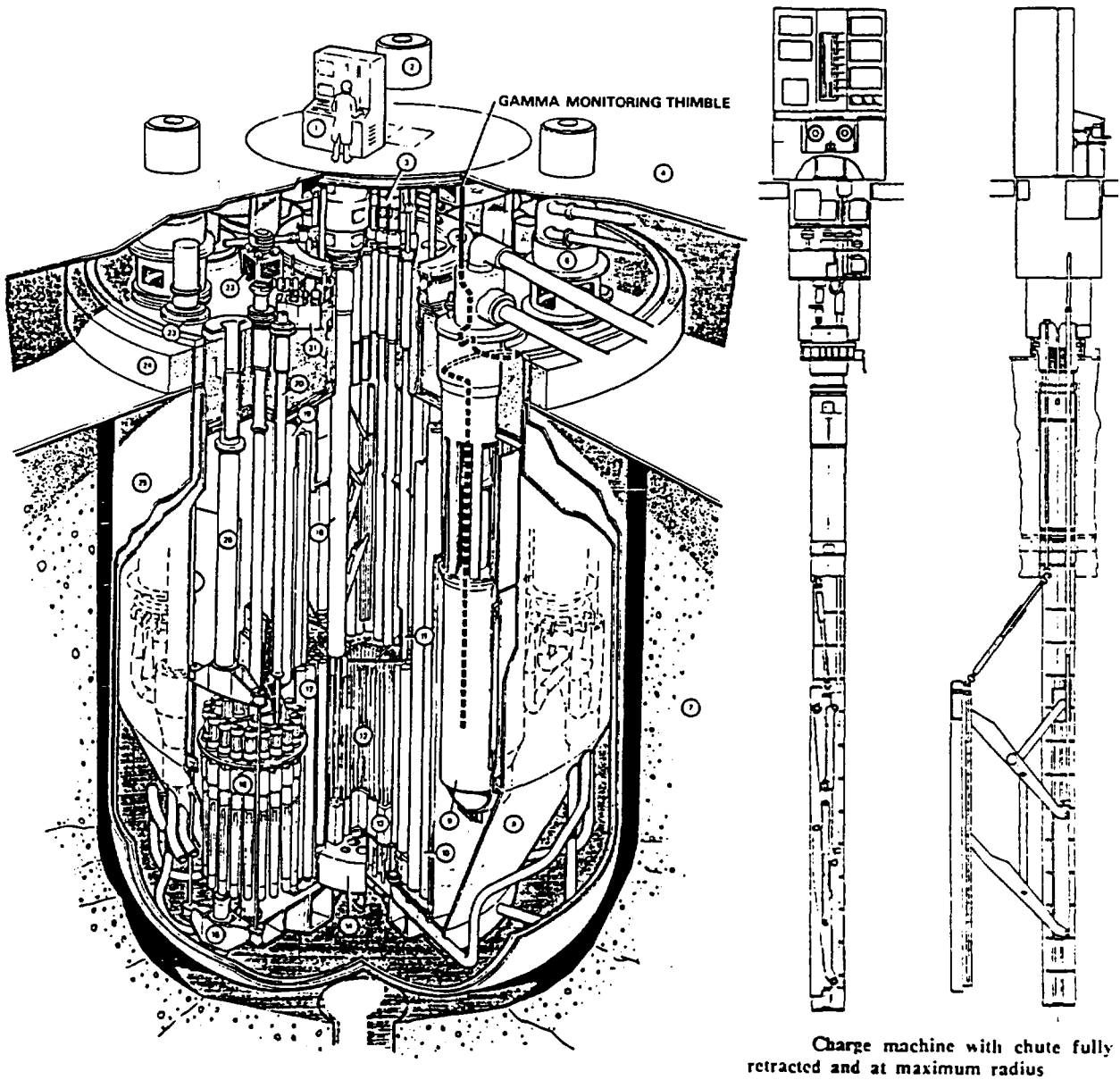

Fig. 5.10.1. Reactor vessel with transfer rotor and charge machine.

arms the chute may be placed above any of the reactor assemblies, and the assembly may be pulled up into the chute. Next the chute

with the assembly is moved out of the reactor area to the top of a transfer rotor (a Lazy Susan arrangement), and the assembly is deposited in a carrier in the rotor. The rotor is rotated to a new position which contains a new fuel assembly. This assembly is picked by the chute and is transferred to the reactor. The spent fuel assembly is stored in the rotor until the decay heat has been reduced to 15 kW. This means a storage period of about one month for an assembly with a burn-up of about 10% of the heavy nuclides. During the storage in the rotor the assembly is cooled by the liquid sodium.

It should be remembered that all handling of assemblies inside the reactor tank is performed under liquid sodium with no possibility of visual control. However, an under-sodium viewer using 1 MHz ultrasonic signals have been used successfully at PFR. A number of scans of the top of the core have been made and excellent pictures obtained.

After the storage period in the rotor the assembly is transferred to the irradiated fuel cave for examination and later transfer to the reprocessing plant. This transfer and also the introduction of new fuel into the system is demonstrated in fig. 5.10.2. The cave is provided with a number of sodium tanks for fuel transfer, storage, examination and disassembly under sodium. The temperature of the sodium in these tanks is by means of electric heating and thermostatically control kept at 100-150°C.

5.11. Safety Features

A number of safety features of the PFR has already been mentioned, but a summary of these features will be presented in this section.

The reactor core has a negative temperature coefficient due to the Doppler effect and thermal expansion of -0.91 cents/°C which will counteract any divergence of the chain reaction. Also the power coefficient is negative. A consequence of the negative coefficients is that should all secondary circuit heat transfer be lost and the control system fails to shut off the reactor while the reactor is running at full power and the primary pumps

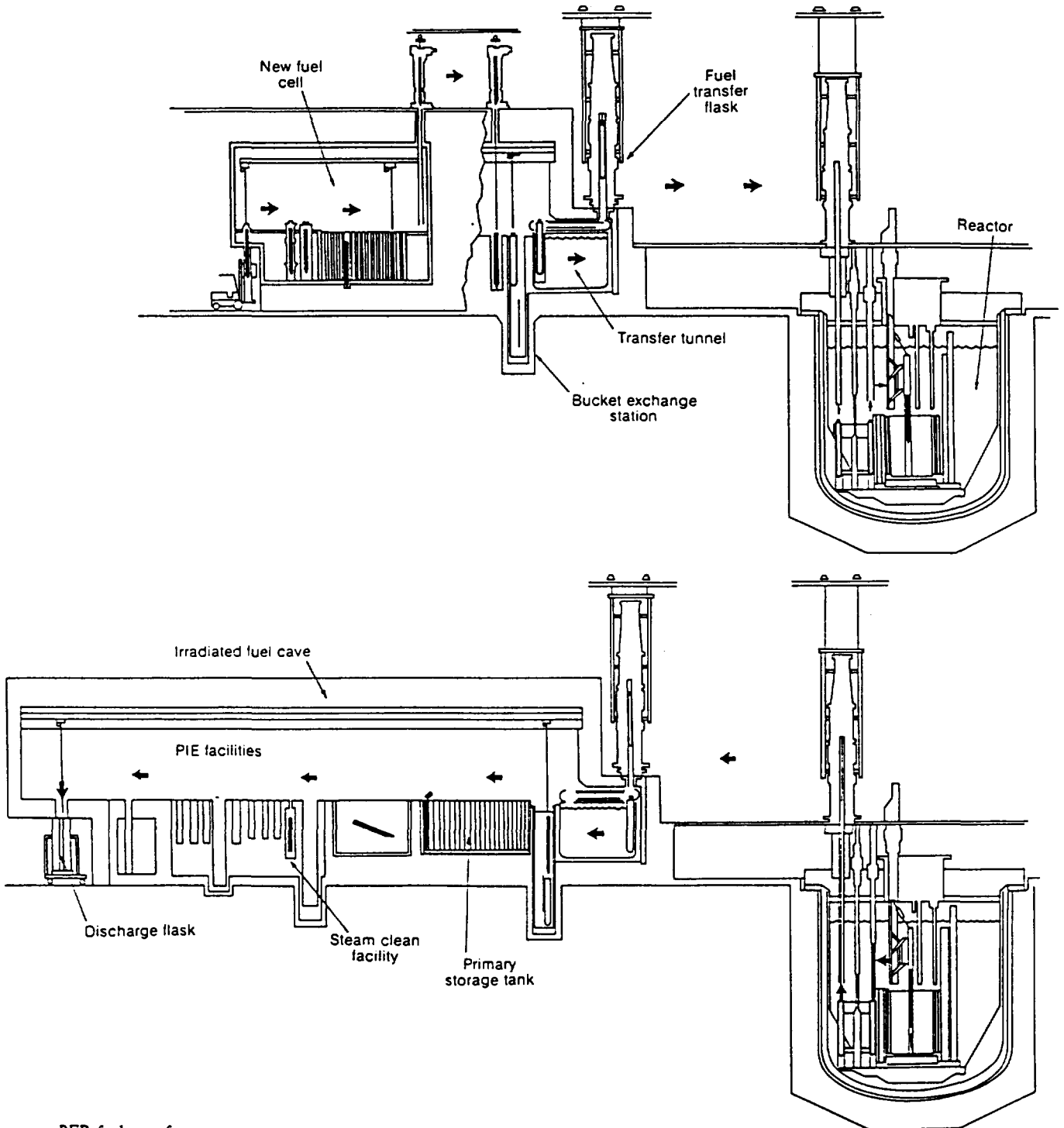

PFR fuel transfer route

Fig. 5.10.2. PFR fuel transfer route from fuel facility to reactor (new fuel) and from reactor to fuel caves (spent fuel).

continue to work, the reactor will shut itself down at a primary circuit temperature of about 600°C. If the primary power system is lost and the control system fails to trip the reactor while operating at full power, the reactor power will be reduced to 20% of full power within 200 s, i.e. within the primary pump run-down time. Further heating-up of the system will shut the reactor down, but there may be some benign fuel pin failures in the process.

Loss of electric power supply to PFR will shut off the reactor, and the primary pumps will run down. Due to the installation of flywheels the pump speed halving time is 10s, and the pumps will stop after about 200s. Before that the pump pony motors which are driven from guaranteed supplies, will take over. The pony motors will maintain a pumping speed of 10%. One pump at 10% will be enough to remove the decay heat. If all pony motors fail the sodium temperature of the core will rise as compared to sodium temperature of the outer pool. Hereby natural circulation will transport the decay heat from the core to the pool. From here the heat can be transferred to the atmosphere by means of the decay heat rejection system. The transition from pumped flow to natural circulation has been demonstrated through experiments with the plant, and the decay heat was removed without the outlet assembly temperatures exceeded normal operating levels.

The reactor operates at a pressure only slightly above atmospheric pressure.

The stainless steel reactor vessel is surrounded by a leak jacket that will prevent the sodium level from dropping below the top of the reactor core in case of a leak in the reactor vessel.

The large pool of sodium in which the reactor is submerged provides a large thermal inertia. In case of a failure of the ordinary heat removal system, three independent, continuously operating, passive decay heat removal systems will remove the decay heat from the reactor.

The introduction of the secondary cooling circuit prevents the radioactive sodium of the primary cooling circuit from getting in contact with water/steam in case of a leak in the steam generator.

It has been estimated that the primary containment barrier, the leak jacket and the roof structure, can withstand an internal explosion of 200 MJ. It has also been estimated that the most severe accident - all control rod dropping out of the core in free fall due to failure of the core support structure - will produce much less energy before the dispersal of the fuel will make the reactor subcritical. Recriticality in connection with a core melt-down is also considered very unlikely.

Should radioactivity escape to the reactor hall through the roof structure, the low leakage from the hall and the filters of the post-accident clean-up plant will ensure that the release to the atmosphere will be very small.

5.12. Control and Instrumentation Systems

In general the control and instrumentation systems of the PFR are similar to those used in other nuclear power systems. The central feature of the control and instrumentation system is an on-line computer, supervising the operation of the plant. The control system consists of two identical sub-systems which work together, but either of which is able to sustain plant operation. In case both sub-systems fail the reactor will be shut down. The system processes about 4000 plant instrument outputs. From this input the system can provide

- Plant operation data, displayed on computer screens in the control room.
- Control information for the two main automatic control loops, reactor outlet temperature controlled by movement of a control rod and steam pressure at the turbine stop valve controlled by variation of the speeds of the primary and the secondary sodium pumps.
- Records of plant performance.
- Supervising operations such as refueling.

5.13. Sodium Purification System

The required purity levels of the sodium of the primary circuit and of the secondary systems are maintained by means of "cold traps". Cold trap purification is used because some elements in the in-core structural materials dissolve in the sodium coolant during normal operation. The cold traps are placed in bypass lines connected to the main sodium loops.

In the cold traps the sodium temperature is reduced to a minimum of 110°C. At this temperature the impurities (hydrides and oxides) are removed by crystallisation on the packing material of the cold traps (stainless steel wire mesh). The packings are replaced when they start to plug. A cold trap for the PFR can accumulate about 100 kg of impurities, corresponding to a service life of about 20 months of the packings.

The cold trap of the primary loop is placed inside a shielded compartment together with a 7 kg/sec pump and a regenerative heat exchanger (economizer). The cold traps are a double wall vessel, about 1.5 m in diameter and 4.9 m long. The inner vessel is made out of 18.8.1 stainless steel and the outer vessel out of 2.25 Cr-1 Mo steel. The lower part of the outer vessel is provided with 300 cooling fins and an air jacket on the outside.

Air cooling reduces the temperature of the sodium from 140°C (outlet temperature of the economizer) to about 110°C which is the inlet temperature of the packing.

The sodium enters at the top of the cold traps and flows down through the annulus between the outer and the inner vessel walls. The air cooling is applied to outside of the outer wall. At the bottom the flow is reversed, and the sodium flows upwards through the central channel and outwards (in radial direction) through the wire mesh packing.

The cold traps are designed to reduce the sodium impurities to 5-10 ppm. In a typical sodium purification system the following elements are monitored:

Boron, carbon, ^{137}Cs , chlorine, chromium, hydrogen, ^{131}I , ^{132}I , ^{133}I , ^{135}I , iron, lithium, manganese, nickel, nitrogen, oxygen, plutonium, tritium and uranium.

5.14. Electrical Power System

The PFR plant is provided with a 300 MW generator which produces up to 250 MW_e. The electrical power is sent to Beaulieu near Inverness, approximately 100 miles to the south, by use of an 275 kV overhead transmission line.

6. REFERENCES

Adams, E.R., Gregory, C.V. and Henderson, J.D.C.: The safety of the prototype fast reactor. Nucl. Energy, Vol.31, June 1992, No.3, 185-191.

Bishop, J.F.: Power from plutonium: fast reactor fuel. Nucl. Energy, Vol.20, Feb.1981, No.1, 31-48.

Bishop, J.F. and Kemp, E.F.: Fuel and fuel for PFR. Nucl. Engr. Int. Aug. 1971, 643-645.

Brocklehurst, J.E. et al.: The performance of boron carbide control rod pins in Prototype Fast Reactor. Nucl. Energy, Vol.23, June 1984, No.3, 179-189.

Broomfield, A.M.: Introductory address - PFR: a retrospective. Nucl. Energy, Vol.33, Aug.1994, No.4, 245-248.

Cambell, R.H.: Construction and engineering of PFR. Nucl. Engr. Int. Aug.1971, 636-642.

Edmonds, E. and Higginson, P.R.: Irradiated fuel cave at Dounreay prototype fast reactor. Nucl. Energy, Vol.19, Dec.1980, No.6, 439-447.

Evans, A.D.: PFR station control and instrumentation. Nucl. Engr. Int. Aug.1971, 641-642.

Henry, K.J.: Technical description of PFR. Nucl. Engr. Int.

Aug. 1971, 632-636.

Holloway, N.J. and Perry, A.: A PRA-based safety case for licensing the prototype fast reactor. International Fast Reactor Safety Meeting. Am. Nucl. Soc. Vol. IV, 23-32.

Moore, R.V.: The Dounreay Prototype Fast Reactor. Nucl. Engr. Int. Aug. 1971, 629.

Newton, T.D.: Role of core neutronic parameter measurements in monitoring the reactivity of the Prototype Fast Reactor at Dounreay. Nucl. Energy, Vol. 31, June 1992, No. 3, 231-238.

Scott, R.W.: PFR components. Nucl. Engr. Int. Aug. 1971, 646-650.

Waltar, A.E and Reynolds, A.B.: Fast breeder reactors. Pergamon Press, 1981.

Status of liquid metal cooled fast breeder reactors. IAEA, Vienna, 1985. Technical report series No. 246.

The Prototype Fast Reactor. Dounreay UKAEA, Nov. 1986, 10 pages.

Distribution of RAK-2.3 reports:

DENMARK:

Danish Nuclear Inspectorate
attn: Louise Dahlerup
Dan Kampmann
Datavej 16
DK-3460 Birkerød
Denmark

Risø National Laboratory
attn: Erik Nonbøl (6 copies)
S. E. Jensen
B. Majborn
P.O. Box 49
DK-4000 Roskilde
Denmark

Kaare Ulbak
SIS
Frederikssundsvej 378
DK-2700 Brønshøj
Denmark

FINLAND:

Prof. Heikki Kalli (2 copies)
Lappeenranta University of Technology
P.O. Box 20
FIN-53851 Lappeenranta
Finland

VTT Energy
attn: Ilona Lindholm (3 copies)
Lasse Mattila
Risto Sairanen
Esko Pekkarinen
P.O. Box 1604
FIN-02044 VTT
Finland

Hannu Ollikkala (2 copies)
Finnish Centre of Radiation &
Nuclear Safety (STUK)
P.O. Box 14
FIN-00881 Helsinki
Finland

Prof. Rainer Salomaa
Helsinki University of Technology
Department of Technical Physics
FIN-02150 Espoo
Finland

Heikki Sjövall
Teollisuuden Voima Oy
FIN-27160 Olkiluoto
Finland

ICELAND:

Tord Walderhaug
Geislavarnir ríkisins
Laugavegur 118 D
IS-150 Reykjavík
Iceland

NORWAY:

Sverre Hornkjöl
Statens Strålevern
P.O. Box 55
N-1345 Österås
Norway

Geir Meyer
IFE/Halden
P.O. Box 173
N-1751 Halden
Norway

Per I Wethe
IFE/Kjeller
P.O. Box 40
N-2007 Kjeller
Norway

SWEDEN:

Kjell Andersson
Karinta-Konsult
Box 6048
S-183 06 Täby
Sweden

Jean-Pierre Bento
KSU AB
Box 1039
S-611 29 Nyköping
Sweden

Statens Kärnkraftinspektion (SKI)
attn: Wiktor Fried (3 copies)
Oddbjörn Sandervåg
Lennart Carlsson
Christer Viktorsson
S-10658 Stockholm
Sweden

Prof. Jan-Olof Liljenzin
Chalmers Tekniska Högskola
S-41296 Göteborg
Sweden

Studsvik EcoSafe AB
attn: Lars Nilsson (2 copies)
Lennart Devell
S-61182 Nyköping
Sweden

Royal Institute of Technology
attn: Prof. Bal Raj Sehgal
Prof. Jan Blomstrand
Dr. Ingemar Tiren
Brinellvägen 60
S-10044 Stockholm
Sweden

Statens Strålsäkerhetsinstitut (SSI)
attn: Jan Olof Snihs (2 copies)
Jack Valentin
S-17116 Stockholm
Sweden

Yngve Waaranperä
ABB Atom AB
S-72163 Vesterås
Sweden

**REFERENCE GROUP FOR THE RAK
PROGRAMME:**

Björn Thorlaksen
Danish Nuclear Inspectorate
Datavej 16
DK-3460 Birkerød
Denmark

Markku Friberg
Industriens Kraft TVO
FIN-27160 Olkiluoto
Finland

Gert Hedner
Statens Kärnkraftinspektion (SKI)
S-10658 Stockholm
Sweden

Magnus Kjellander
KSU AB
Box 1039
S-611 29 Nyköping
Sweden

Petra Lundström
IVO International Oy
FIN-01019 IVI
Finland

Gustav Löwenhielm
FKA
Forsmarks Kraftgrupp AB
S-742 03 Östhammar
Sweden

Lasse Reiman
Finnish Centre of Radiation &
Nuclear Safety (STUK)
P.O. Box 14
FIN-00881 Helsinki
Finland

Egil Stokke
IFE/Halden
P.O. Box 173
N-1751 Halden
Norway

Jan-Anders Svensson
Barsebäck Kraft AB
Box 524
S-246 25 Löddeköpinge
Sweden

Björn Wahlström
VTT Automation
P.O. Box 13002
FIN-02044 VTT
Finland

Povl L. Ølgaard (3 copies)
Risø National Laboratory
P.O. Box 49
DK-4000 Roskilde
Denmark

EXECUTIVE SECRETARY:

Torkel Bennerstedt
NKS
PL 2336
S-76010 Bergshamra
Sweden