

November 2009

# NUCLEAR WASTE MANAGEMENT

## Key Attributes, Challenges, and Costs for the Yucca Mountain Repository and Two Potential Alternatives



GAO

Accountability \* Integrity \* Reliability



Highlights of [GAO-10-48](#), a report to congressional requesters

## Why GAO Did This Study

High-level nuclear waste—one of the nation's most hazardous substances—is accumulating at 80 sites in 35 states. The United States has generated 70,000 metric tons of nuclear waste and is expected to generate 153,000 metric tons by 2055. The Nuclear Waste Policy Act of 1982, as amended, requires the Department of Energy (DOE) to dispose of the waste in a geologic repository at Yucca Mountain, about 100 miles northwest of Las Vegas, Nevada. However, the repository is more than a decade behind schedule, and the nuclear waste generally remains at the commercial nuclear reactor sites and DOE sites where it was generated.

This report examines the key attributes, challenges, and costs of the Yucca Mountain repository and the two principal alternatives to a repository that nuclear waste management experts identified: storing the nuclear waste at two centralized locations and continuing to store the waste on site where it was generated. GAO developed models of total cost ranges for each alternative using component cost estimates provided by the nuclear waste management experts. However, GAO did not compare these alternatives because of significant differences in their inherent characteristics that could not be quantified.

## What GAO Recommends

GAO is making no recommendations in this report. In written comments, DOE and NRC generally agreed with the report.

View [GAO-10-48](#) or [key components](#). For more information, contact Mark Gaffigan at 202-512-3841 or [gaffiganm@gao.gov](mailto:gaffiganm@gao.gov).

# NUCLEAR WASTE MANAGEMENT

## Key Attributes, Challenges, and Costs of the Yucca Mountain Repository and Two Potential Alternatives

### What GAO Found

The Yucca Mountain repository is designed to provide a permanent solution for managing nuclear waste, minimize the uncertainty of future waste safety, and enable DOE to begin fulfilling its legal obligation under the Nuclear Waste Policy Act to take custody of commercial waste, which began in 1998. However, project delays have led to utility lawsuits that DOE estimates are costing taxpayers about \$12.3 billion in damages through 2020 and could cost \$500 million per year after 2020, though the outcome of pending litigation may affect the government's total liability. Also, the administration has announced plans to terminate Yucca Mountain and seek alternatives. Even if DOE continues the program, it must obtain a Nuclear Regulatory Commission construction and operations license, a process likely to be delayed by budget shortfalls. GAO's analysis of DOE's cost projections found that a repository to dispose of 153,000 metric tons would cost from \$41 billion to \$67 billion (in 2009 present value) over a 143-year period until the repository is closed. Nuclear power rate payers would pay about 80 percent of these costs, and taxpayers would pay about 20 percent.

Centralized storage at two locations provides an alternative that could be implemented within 10 to 30 years, allowing more time to consider final disposal options, nuclear waste to be removed from decommissioned reactor sites, and the government to take custody of commercial nuclear waste, saving billions of dollars in liabilities. However, DOE's statutory authority to provide centralized storage is uncertain, and finding a state willing to host a facility could be extremely challenging. In addition, centralized storage does not provide for final waste disposal, so much of the waste would be transported twice to reach its final destination. Using cost data from experts, GAO estimated the 2009 present value cost of centralized storage of 153,000 metric tons at the end of 100 years to range from \$15 billion to \$29 billion but increasing to between \$23 billion and \$81 billion with final geologic disposal.

On-site storage would provide an alternative requiring little change from the status quo, but would face increasing challenges over time. It would also allow time for consideration of final disposal options. The additional time in on-site storage would make the waste safer to handle, reducing risks when waste is transported for final disposal. However, the government is unlikely to take custody of the waste, especially at operating nuclear reactor sites, which could result in significant financial liabilities that would increase over time. Not taking custody could also intensify public opposition to spent fuel storage site renewals and reactor license extensions, particularly with no plan in place for final waste disposition. In addition, extended on-site storage could introduce possible risks to the safety and security of the waste as the storage systems degrade and the waste decays, potentially requiring new maintenance and security measures. Using cost data from experts, GAO estimated the 2009 present value cost of on-site storage of 153,000 metric tons at the end of 100 years to range from \$13 billion to \$34 billion but increasing to between \$20 billion to \$97 billion with final geologic disposal.

---

# Contents

---

|                     |   |           |
|---------------------|---|-----------|
| <b>Letter</b>       |   | <b>1</b>  |
|                     | Background  | 5         |
|                     | The Yucca Mountain Repository Would Provide a Permanent Solution for Nuclear Waste, but Its Implementation Faces Challenges and Significant Upfront Costs | 13        |
|                     | We Identified Two Nuclear Waste Management Alternatives and Developed Cost Models by Consulting with Experts  | 22        |
|                     | Centralized Storage Would Provide a Near-Term Alternative, Allowing Other Options to Be Studied, but Faces Implementation Challenges                      | 29        |
|                     | On-Site Storage Would Provide an Intermediate Option with Minimal Effort but Poses Challenges that Could Increase Over Time                               | 36        |
|                     | Concluding Observations   | 40        |
|                     | Agency Comments   | 41        |
| <b>Appendix I</b>   | <b>Scope and Methodology</b>  | <b>43</b> |
| <b>Appendix II</b>  | <b>Our Methodology for Obtaining Comments from Nuclear Waste Management Experts</b>   | <b>49</b> |
| <b>Appendix III</b> | <b>Nuclear Waste Management Experts We Interviewed</b>  | <b>57</b> |
| <b>Appendix IV</b>  | <b>Modeling Methodology, Assumptions, and Results</b>   | <b>62</b> |
| <b>Appendix V</b>   | <b>Comments from the Department of Energy</b>   | <b>76</b> |
| <b>Appendix VI</b>  | <b>Comments from the Nuclear Regulatory Commission</b>  | <b>77</b> |
| <b>Appendix VII</b> | <b>GAO Contact and Staff Acknowledgments</b>  | <b>78</b> |

---

---

## Tables

|   |    |
|---|----|
| Table 1: Estimated Cost of the Yucca Mountain Scenarios   | 19 |
| Table 2: Key Assumptions Used to Define Alternatives  | 23 |
| Table 3: Models and Scenarios Used for Cost Ranges  | 27 |
| Table 4: Estimated Cost Range for Each Centralized Storage Scenario   | 34 |
| Table 5: Estimated Cost Range for Each On-site Storage Scenario   | 39 |
| Table 6: Our Data Collection Instrument for Nuclear Waste Management Experts  | 50 |
| Table 7: Initial Assumptions and Component Cost Estimates for Our Centralized Storage and On-site Storage Alternatives and Modifications Made Based on Experts' Responses to Our Data Collection Instrument | 52 |
| Table 8: Model Results for All Scenarios  | 71 |

---

## Figures

|  |    |
|--|----|
| Figure 1: Current Storage Sites and Proposed Repository for High-Level Nuclear Waste                     | 2  |
| Figure 2: Aerial View and Cut-Out of the Yucca Mountain Repository                                       | 6  |
| Figure 3: Dry Cask Storage System for Spent Nuclear Fuel   | 9  |
| Figure 4: Cost Profile for the Yucca Mountain Repository, Assuming 70,000 Metric Tons                    | 20 |
| Figure 5: Process Assumptions and Cost Components for Hypothetical Nuclear Waste Management Alternatives | 25 |
| Figure 6: Scenario and Cost Time Frames for the Centralized 153,000 Metric Ton Models                    | 67 |
| Figure 7: Scenario and Cost Time Frames for the Centralized 70,000 Metric Ton Model                      | 68 |
| Figure 8: Scenarios and Cost Time Frames for the On-Site 153,000 Metric Ton Models                       | 69 |
| Figure 9: Scenario and Cost Time Frames for the On-Site 70,000 Metric Ton Model                          | 70 |
| Figure 10: Total Cost Ranges for Centralized Storage for 100 Years with Final Disposition                | 72 |
| Figure 11: Total Cost Ranges for On-site Storage for 100 years with Final Disposition                    | 73 |
| Figure 12: Total Cost Ranges of On-Site Storage over 2,000 Years   | 74 |

---

---

## **Abbreviations**

|      |                                  |
|------|----------------------------------|
| DOE  | Department of Energy             |
| EPA  | Environmental Protection Agency  |
| NRC  | Nuclear Regulatory Commission    |
| NWPA | Nuclear Waste Policy Act of 1982 |

This is a work of the U.S. government and is not subject to copyright protection in the United States. The published product may be reproduced and distributed in its entirety without further permission from GAO. However, because this work may contain copyrighted images or other material, permission from the copyright holder may be necessary if you wish to reproduce this material separately.



United States Government Accountability Office  
Washington, DC 20548

November 4, 2009

The Honorable Barbara Boxer  
Chairman  
Committee on Environment and Public Works  
United States Senate

The Honorable Harry Reid  
United States Senate

The Honorable John Ensign  
United States Senate

High-level nuclear waste consists mostly of spent nuclear fuel removed from commercial power reactors and is considered one of the most hazardous substances on earth. The U.S. national inventory of 70,000 metric tons of nuclear waste—enough to fill a football field more than 15 feet deep—has been accumulating at 80 sites in 35 states since the mid-1940s and is expected to more than double to 153,000 metric tons by 2055. The current national policy of constructing a federal repository to dispose of this waste at Yucca Mountain—which is about 100 miles northwest of Las Vegas, Nevada—has already been delayed more than a decade. As a result, nuclear waste generally remains at the sites where it was generated. Experts and regulators believe the nuclear waste, if properly stored and monitored, can be kept safe and secure on-site for decades; but communities across the country have raised concerns about the waste’s lethal nature and the possibility of natural disasters or terrorism, particularly at sites near urban centers or sources of drinking water. Industry has also raised concerns that local communities will not support the expansion of the nuclear energy industry without a final waste disposition pathway. Many experts and communities view nuclear energy as a potential means of meeting future energy demands while reducing reliance on fossil fuels and cutting carbon emissions, a key contributor to climate change.

In addition to the spent nuclear fuel generated by commercial power reactors, the Department of Energy (DOE) owns and manages about 19 percent of the nuclear waste—referred to as DOE-managed spent nuclear fuel and high-level waste—which consists of spent nuclear fuel from power, research, and navy shipboard reactors, and high-level nuclear waste from the nation’s nuclear weapons program. (See fig. 1 for the locations where nuclear waste is stored.)

**Figure 1: Current Storage Sites and Proposed Repository for High-Level Nuclear Waste**

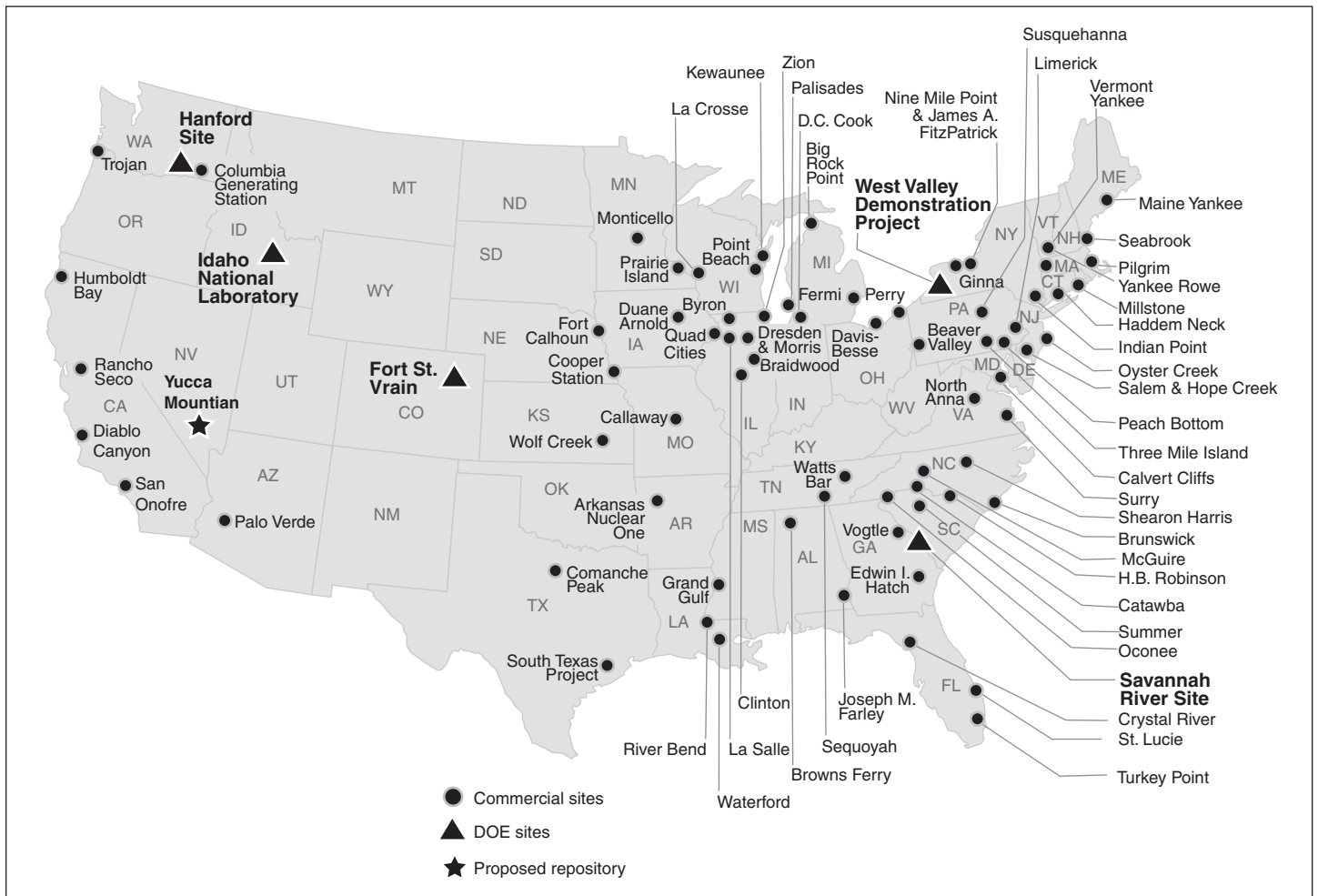

Source: DOE.

Note: Locations are approximate. DOE has reported that it is responsible for managing nuclear waste at 121 sites in 39 states, but DOE officials told us that several sites have only research reactors that generate small amounts of waste that will be consolidated at the Idaho National Laboratory for packaging prior to disposal.

Under the Nuclear Waste Policy Act of 1982 (NWP), as amended, DOE was to evaluate one or more national geologic repositories that would be designated to permanently store commercial spent nuclear fuel and DOE-managed spent nuclear fuel and high-level waste. NWP was amended in 1987 to direct DOE to evaluate only the Yucca Mountain site. In 2002, the president recommended and the Congress approved the Yucca Mountain site as the nation’s geologic repository. The repository is intended to

---

isolate nuclear waste from humans and the environment for thousands of years, long enough for its radioactivity to decay to near natural background levels. NWPA set January 31, 1998, as the date for DOE to start accepting nuclear waste for disposal. To meet this goal, DOE has spent more than \$14 billion for design, engineering, and testing activities.<sup>1</sup> In June 2008, DOE submitted a license application to the Nuclear Regulatory Commission (NRC) for approval to construct the repository. In July 2008, DOE reported that its best achievable date for opening the repository, if it receives NRC approval, is in 2020. Delays in the Yucca Mountain repository have resulted in a need for continued storage of the waste onsite, leaving industry uncertain regarding the licensing of new nuclear power reactors and the nation uncertain regarding a final disposition of the waste.

In March 2009, the Secretary of Energy testified that the administration planned to terminate the Yucca Mountain repository. Since then, the administration has announced plans to study alternatives to geologic disposal at Yucca Mountain before making a decision on a future nuclear waste management strategy, which the administration said could include reprocessing or other complementary strategies.

In this context, you asked us to identify key aspects of DOE's nuclear waste management program and other possible management approaches. Specifically, you asked us to examine (1) the key attributes, challenges, and costs of the Yucca Mountain repository; (2) and identify alternative nuclear waste management approaches; (3) the key attributes, challenges, and costs of storing the nuclear waste at two centralized sites; and (4) the key attributes, challenges, and costs of continuing to store the nuclear waste at its current locations. The centralized storage and onsite storage options—both with disposal scenarios—were the two most likely alternative approaches identified by the experts we interviewed. We are also providing information on what is known about sources of funding—primarily taxpayers and nuclear power rate payers—for the Yucca Mountain repository and the two alternative approaches.

To examine the key attributes, challenges, and costs of the Yucca Mountain repository, we obtained reports and supporting documentation

---

<sup>1</sup>In constant fiscal year 2009 dollars. Funding comes primarily from fees collected from electric power companies operating commercial reactors and appropriations for DOE-managed spent nuclear fuel and high-level waste.



---

from DOE, NRC, the National Academy of Sciences, and the Nuclear Waste Technical Review Board. Specifically, we used DOE's report on the Yucca Mountain repository's total lifecycle cost to analyze the cost for disposing of either (1) 70,000 metric tons of nuclear waste, which is the statutory cap on the amount of waste that can be disposed of at Yucca Mountain, or (2) 153,000 metric tons, which is the estimated total amount of nuclear waste that has already been generated and will be generated if all currently operating commercial reactors operate for a 60-year lifespan.<sup>2</sup> We then discounted these costs to 2009 present value.

To identify alternative nuclear waste management approaches, we interviewed DOE officials, experts at the National Academy of Sciences and the Nuclear Waste Technical Review Board, and executives at the Nuclear Energy Institute, among others. Based on their comments, we identified two generic alternative approaches for managing this waste for at least a 100-year period before it is disposed in a repository: storing the nuclear waste at two centralized facilities—referred to as centralized storage—and continuing to store the nuclear waste on site at their current facilities—referred to as on-site storage. To examine the key attributes, challenges, and costs of each alternative, we asked nuclear waste management experts from federal agencies, industry, academic institutions, and concerned groups to comment on the attributes and challenges of each alternative, provide relevant cost data, and comment on the assumptions and cost components that we used to develop cost models for the alternatives. We then used the models to produce the total cost ranges for each alternative with and without final disposal in a geologic repository at the end of a 100-year specific time period. In addition, we analyzed onsite storage for longer periods than 100 years. We analyzed costs associated with storing 70,000 metric tons and 153,000 metric tons and discounted the costs to 2009 present value.

We did not compare the Yucca Mountain cost range to the ranges of other alternatives because of significant differences in inherent characteristics of these alternatives that our modeling work could not quantify. For example, the safety, health, and environmental risks for each are very different, which needs to be considered in the policy debate on nuclear waste management decisions. (See app. I for additional information about our scope and methodology, app. II for our methodology for soliciting

---

<sup>2</sup>DOE, *Analysis of the Total System Lifecycle Cost of the Civilian Radioactive Waste Management Program, Fiscal Year 2007*, DOE/RW-0591 (Washington, D.C., July 2008).

---

comments from nuclear waste management experts, and app. III for a list of these experts.)

We conducted this performance audit from April 2008 to October 2009 in accordance with generally accepted government auditing standards. Those standards require that we plan and perform the audit to obtain sufficient, appropriate evidence to provide a reasonable basis for our findings and conclusions based on our audit objectives. We believe that the evidence obtained provides a reasonable basis for our findings and conclusions based on our audit objectives.

---

## Background

Nuclear waste is long-lived and very hazardous—without protective shielding, the intense radioactivity of the waste can kill a person within minutes or cause cancer months or even decades after exposure.<sup>3</sup> Thus, careful management is required to isolate it from humans and the environment. To accomplish this, the National Academy of Sciences first endorsed the concept of nuclear waste disposal in deep geologic formations in a 1957 report to the U.S. Atomic Energy Commission, which has since been articulated by experts as the safest and most secure method of permanent disposal.<sup>4</sup> However, progress toward developing a geologic repository was slow until NWPA was enacted in 1983. Citing the potential risks of the accumulating amounts of nuclear waste, NWPA required the federal government to take responsibility for the disposition of nuclear waste and required DOE to develop a permanent geologic repository to protect public health and safety and the environment for

---

<sup>3</sup>For the purposes of our report, nuclear waste includes both spent nuclear fuel—fuel that has been withdrawn from a nuclear reactor following irradiation—and high-level radioactive waste—generally the material resulting from the reprocessing of spent nuclear fuel. Nuclear waste—specifically spent nuclear fuel—is also very thermally hot. As the radioactive elements in spent nuclear fuel decay, they give off heat. However, according to DOE data, a spent nuclear fuel assembly can lose nearly 80 percent of its heat 5 years after it has been removed from a reactor and about 95 percent of its heat after 100 years.

<sup>4</sup>National Academy of Sciences, *The Disposal of Radioactive Waste on Land*, (Washington, D.C., September 1957). This report suggested several potential alternatives for disposal of nuclear waste, stressing that although there are many potential sites for geologic disposal of waste at various depths and in various geologic formations, further research was needed regarding specific waste forms and specific geologic formations, including disposal in deep underground formations. The report stated, “the hazard related to radioactive waste is so great that no element of doubt should be allowed to exist regarding safety.” Subsequent reports by the National Academy of Sciences and others have continued to endorse geologic isolation of nuclear waste and have suggested that engineered barriers, such as corrosion-resistant containers, can provide additional layers of isolation.

current and future generations. Specifically, the act required DOE to study several locations around the country for possible repository sites and develop a contractual relationship with industry for disposal of the nuclear waste. The Congress amended NWPA in 1987 to restrict scientific study and characterization of a possible repository to only Yucca Mountain. (Fig. 2 shows the north crest of Yucca Mountain and a cut-out of the proposed mined repository.)

**Figure 2: Aerial View and Cut-Out of the Yucca Mountain Repository**

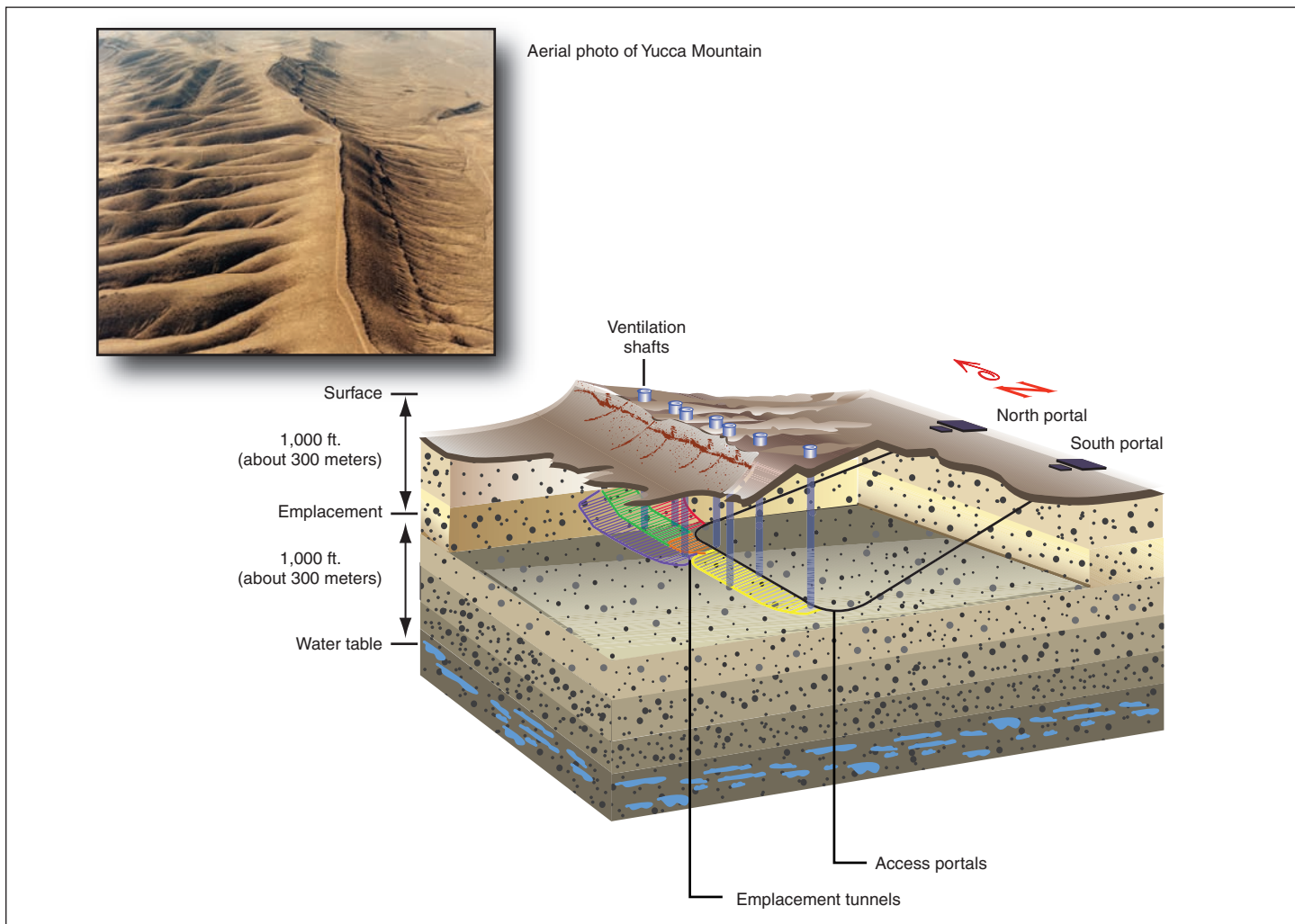

Source: DOE.

After the Congress approved Yucca Mountain as a suitable site for the development of a permanent nuclear waste repository in 2002, DOE began

---

preparing a license application for submittal to NRC, which has regulatory authority over commercial nuclear waste management facilities. DOE submitted its license application to NRC in June 2008, and NRC accepted the license application for review in September 2008. NWPA requires NRC to complete its review of DOE's license application for the Yucca Mountain repository in 3 years, although a fourth year is allowed if NRC deems it necessary and complies with certain reporting requirements.

To pay the nuclear power industry's share of the cost for the Yucca Mountain repository, NWPA established the Nuclear Waste Fund, which is funded by a fee of one mill (one-tenth of a cent) per kilowatt-hour of nuclear-generated electricity that the federal government collects from electric power companies. DOE reported that, at the end of fiscal year 2008, the Nuclear Waste Fund contained \$22 billion, with an additional \$1.9 billion projected to be added in 2009. DOE receives money from the Nuclear Waste Fund through congressional appropriations. Additional funding for the repository comes from an appropriation which provides for the disposal cost of DOE-managed spent nuclear fuel and high-level waste.

NWPA caps nuclear waste that can be disposed of at the Yucca Mountain repository at 70,000 metric tons until a second repository is available. However, the nation has already accumulated about 70,000 metric tons of nuclear waste at current reactor sites and DOE facilities. Without a change in the law to raise the cap or to allow the construction of a second repository, DOE can dispose of only the current nuclear waste inventory. The nation will have to develop a strategy for an additional 83,000 metric tons of waste expected to be generated if NRC issues 20-year license extensions to all of the currently operating nuclear reactors.<sup>5</sup> This amount does not include any nuclear waste generated by new reactors or future defense activities, or greater than class C nuclear waste.<sup>6</sup> According to

---

<sup>5</sup>NRC has already issued license extensions for 54 reactors, enabling them to operate for a total of 60 years. Extension requests for 21 units are currently under review and requests for as many as 25 more are anticipated through 2017.

<sup>6</sup>As of October 2009, NRC has received 18 applications for 29 new reactors. In addition to spent nuclear fuel and DOE-managed high-level waste, the nation also generates so-called greater than class C nuclear waste from the maintenance and decommissioning of nuclear power plants, from radioactive materials that were once used for food irradiation or for medical purposes, and from miscellaneous radioactive waste, such as contaminated equipment from industrial research and development. DOE, which is required to dispose of this nuclear waste, has not issued an environmental impact statement describing potential options, which could include disposal of the waste at the Yucca Mountain repository.

---

DOE and industry studies, three to four times the 70,000 metric tons—and possibly more—could potentially be disposed safely in Yucca Mountain, which could address current and some future waste inventories, potentially delaying the need for a second repository for several generations.

Nuclear waste has continued to accumulate at the nation's commercial and DOE nuclear facilities over the past 60 years. Facility managers must actively manage the nuclear waste by continually isolating, confining, and monitoring it to keep humans and the environment safe. Most spent nuclear fuel is stored at reactor sites, immersed in pools of water designed to cool and isolate it from the environment. With nowhere to dispose of the spent nuclear fuel, the racks holding spent fuel in the pools have been rearranged to allow for more dense storage of assemblies. Even with this re-racking, spent nuclear fuel pools are reaching their capacities. Some critics have expressed concern about the remote possibility of an overcrowded spent nuclear fuel pool releasing large amounts of radiation if an accident or other event caused the pool to lose water, potentially leading to a fire that could disperse radioactive material. As reactor operators have run out of space in their spent nuclear fuel pools, they have turned in increasing number to dry cask storage systems that generally consist of stainless steel canisters placed inside larger stainless steel or concrete casks. (See fig. 3.) NRC requires protective shielding, routine inspections and monitoring, and security systems to isolate the nuclear waste to protect humans and the environment.

**Figure 3: Dry Cask Storage System for Spent Nuclear Fuel**

At some nuclear reactors across the country, spent fuel is kept on site, above ground, in systems basically similar to the one shown here.

- 1** Once the spent fuel has cooled, it is loaded into special canisters, each of which is designed to hold about two dozen assemblies. Water and air are removed. The canister is filled with inert gas, welded shut, and rigorously tested for leaks. It may then be placed in a "cask" for storage or transportation.

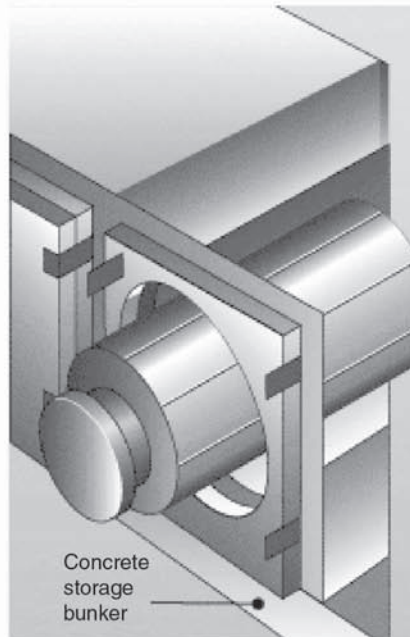
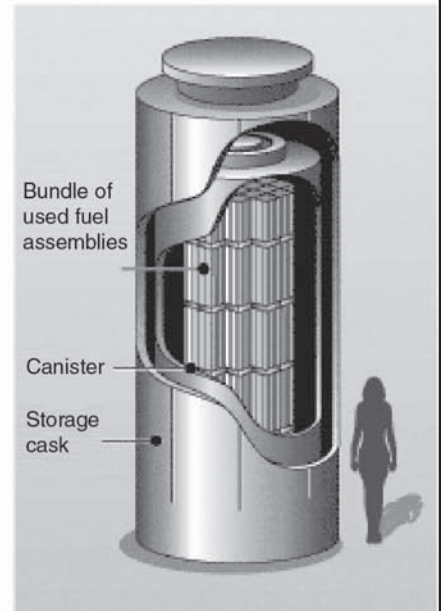

- 2** The canisters can also be stored in above ground concrete bunkers, each of which is about the size of a one-car garage. Eventually they may be transported elsewhere for storage.

Source: NRC.

---

NRC has determined that these dry cask storage systems can safely store nuclear waste, but NRC considers them to be interim measures. In 1990, NRC issued a revised waste confidence rule, stating that it had confidence that the waste generated by a reactor can be safely stored in either wet or dry storage for 30 years beyond a reactor's life, including license extensions. NRC further determined that it had reasonable assurance that safe geologic disposal was feasible and that a geologic repository would be operational by about 2025. More recently, NRC has published a notice of proposed rulemaking to revise that rule, proposing that waste generated by a reactor can be safely stored for 60 years beyond the life of a reactor and that geologic disposal would be available in 50 to 60 years beyond a reactor's life.<sup>7</sup> NRC is currently considering whether to republish its proposed rule to seek additional public input on certain issues. Forty-five reactor sites or former reactor sites in 30 states have dry storage facilities for their spent nuclear fuel as of June 2009, and the number of reactor sites storing spent nuclear fuel is likely to continue to grow until an alternative is implemented.

Implementing a permanent, safe, and secure disposal solution for the nuclear waste is of concern to the nation, particularly state governments and local communities, because many of the 80 sites where nuclear waste is currently stored are near large populations or major water sources or consist of shutdown reactor sites that tie up land that could be used for other purposes. In addition, states that have DOE facilities with nuclear waste storage are concerned because of possible contamination to aquifers, rivers, and other natural resources. DOE's Hanford Reservation, located near Richland, Washington, was a major component of the nation's nuclear weapons defense program from 1943 until 1989, when operations ceased. In the settlement of a lawsuit filed by the state of Washington in 2003, DOE agreed not to ship certain nuclear waste to Hanford until environmental reviews were complete. In August 2009, the U.S. government stated that the preferred alternative in DOE's environmental review would include limitations on certain nuclear waste shipments to Hanford until the process of immobilizing tank waste in glass begins,

---

<sup>7</sup>See 73 Fed. Reg. 59551-59570 (Oct. 9, 2008).

---

expected in 2019.<sup>8</sup> Moreover, some commercial and DOE sites where the nuclear waste is stored may not be able to accommodate much additional waste safely because of limited storage space or community objections. These sites will require a more immediate solution.

The nation has considered proposals to build centralized storage facilities where waste from reactor sites could be consolidated. The 1987 amendment to NWPA established the Office of the Nuclear Waste Negotiator to try to broker an agreement for a community to host a repository or interim storage facility. Two negotiators worked with local communities and Native American tribes for several years, but neither was able to conclude a proposed agreement with a willing community by January 1995, when the office's authority expired. Subsequently, in 2006 after a 9-year licensing process, a consortium of electric power companies called Private Fuel Storage obtained a NRC license for a private centralized storage facility on the reservation of the Skull Valley Band of the Goshute Indians in Utah. NRC's 20-year license—with an option for an additional 20 years—allows storage of up to 40,000 metric tons of commercial spent nuclear fuel. However, construction of the Private Fuel Storage facility has been delayed by Department of the Interior decisions not to approve the lease of tribal lands to Private Fuel Storage and declining to issue the necessary rights-of-way to transport nuclear waste to the facility through Bureau of Land Management land. Private Fuel Storage and the Skull Valley Band of Goshutes filed a federal lawsuit in 2007 to overturn Interior's decisions.

Reprocessing nuclear waste could potentially reduce, but not eliminate, the amount of waste for disposal. In reprocessing, usable uranium and plutonium are recovered from spent nuclear fuel and are used to make new fuel rods. However, current reprocessing technologies separate weapons usable plutonium and other fissionable materials from the spent nuclear fuel, raising concerns about nuclear proliferation by terrorists or

---

<sup>8</sup>The U.S. government made this statement in a letter related to a tentative settlement agreement in the lawsuit of *State of Washington v. Chu*, No. CV-08-5085-FVS (E.D. Washington, filed Nov. 26, 2008). In 2008, the state of Washington filed suit claiming DOE had violated the Tri-Party Agreement among DOE, the state, and the Environmental Protection Agency by failing to meet enforceable cleanup milestones in the agreement. On August 10, 2009, DOE and the state announced they had reached a tentative settlement, including new cleanup milestones and a 2047 completion date for certain key cleanup activities. We have questioned DOE's ability to meet this date. See GAO, *Nuclear Waste: Uncertainties and Questions about Costs and Risks Persist with DOE's Tank Waste Cleanup Strategy at Hanford*, [GAO-09-913](#) (Washington, D.C.: Sept. 30, 2009).



---

enemy states. Although the United States pioneered the reprocessing technologies used by other countries, such as France and Russia, presidents Gerald Ford and Jimmy Carter ended government support for commercial reprocessing in the United States in 1976 and 1977, respectively, primarily due to proliferation concerns. Although President Ronald Reagan lifted the ban on government support in 1981, the nation has not embarked on any reprocessing program due to proliferation and cost concerns—the Congressional Budget Office recently reported that current reprocessing technologies are more expensive than direct disposal of the waste in a geologic repository.<sup>9</sup> DOE’s Fuel Cycle Research and Development program is currently performing research in reprocessing technologies that would not separate out weapons usable plutonium, but it is not certain whether these technologies will become cost-effective.<sup>10</sup>

The general consensus of the international scientific community is that geologic disposal is the preferred long-term nuclear waste management alternative. Finland, Sweden, Canada, France, and Switzerland have decided to construct geologic disposal facilities, but none have yet completed any such facility, although DOE reports that Finland and Sweden have announced plans to begin emplacement operations in 2020 and 2023, respectively. Moreover, some countries employ a mix of complementary storage alternatives in their national waste management strategies, including on-site storage, consolidated interim storage, reprocessing, and geologic disposal. For example, Sweden plans to rely on on-site storage until the waste cools enough to move it to a centralized storage facility, where the waste will continue to cool and decay for an additional 30 years. This waste will then be placed in a geologic repository for disposal. France reprocesses the spent nuclear fuel, recycling usable portions as new fuel and storing the remainder for eventual disposal.

---

<sup>9</sup>Congressional Budget Office, *Costs of Reprocessing Versus Directly Disposing of Spent Nuclear Fuel; Testimony before the Committee on Energy and Natural Resources* (Washington, D.C.: Nov. 14, 2007).

<sup>10</sup>DOE changed the name of this program from the Advanced Fuel Cycle Initiative to the Fuel Cycle Research and Development program in its fiscal year 2010 budget submission.

---

## The Yucca Mountain Repository Would Provide a Permanent Solution for Nuclear Waste, but Its Implementation Faces Challenges and Significant Upfront Costs

The Yucca Mountain repository—mandated by NWPA, as amended—would provide a permanent nuclear waste management solution for the nation’s current inventory of about 70,000 metric tons of waste. According to DOE and industry studies, the repository potentially could be a disposal site for three to four times that amount of waste. However, the repository lacks the support of the administration and the state of Nevada, and faces regulatory and other challenges. Our analysis of DOE’s cost projections found that the Yucca Mountain repository would cost from \$41 billion to \$67 billion (in 2009 present value) for disposing of 153,000 metric tons of nuclear waste.<sup>11</sup> Most of these costs are up-front capital costs. However, once the Yucca Mountain repository is closed—in 2151 for our 153,000-metric-ton model—it is not expected to incur any significant additional costs, according to DOE.

---

## As Designed, the Yucca Mountain Repository Would Be a Permanent Solution and Would Reduce the Uncertainty Associated with Future Nuclear Waste Safety

The Yucca Mountain repository is designed to isolate nuclear waste in a safe and secure environment long enough for the waste to degrade into a form that is less harmful to humans and the environment. As nuclear waste ages, it cools and decays, becoming less radiologically dangerous. In October 2008, after years of legal challenges, the Environmental Protection Agency (EPA) promulgated standards that require DOE to ensure that radioactive releases from the nuclear waste disposed of at Yucca Mountain do not harm the public for 1 million years.<sup>12</sup> This is because some waste components, such as plutonium 239, take hundreds of thousands of years to decay into less harmful materials. To meet EPA’s standards and keep the waste safely isolated, DOE’s license application proposes the use of both natural and engineered barriers. Key natural barriers of Yucca Mountain include its dry climate, the depth and isolation

---

<sup>11</sup>Our cost range for a permanent repository differs from DOE’s most recent estimate of \$96 billion for the following reasons: First, our cost range is in 2009 present value, while DOE uses 2007 constant dollars, which are not discounted. Our present value analysis reflects the time value of money—costs incurred in the future are worth less today—so that streams of future costs become smaller. Second, our cost range does not include about \$14 billion in previously incurred costs. Third, our cost range is for 153,000 metric tons of nuclear waste while DOE’s estimated cost is for 122,100 metric tons. Finally, we use a range while DOE provides a point estimate.

<sup>12</sup>The Energy Policy Act of 1992 directed EPA to base its health standards on a National Academy of Sciences study of the health issues related to radioactive releases. NRC has promulgated rules based on EPA’s October 2008 standards that require the Yucca Mountain repository to limit the annual radiation dose of the public to at most 15 millirem for the first 10,000 years after disposal and at most 100 millirem from 10,001 years to 1 million years after disposal. In contrast, the average American is exposed to about 360 millirem of radiation annually, mainly from natural background sources.

---

of the Death Valley aquifer in which the mountain resides, its natural physical shape, and the layers of thick rock above and below the repository that lie 1,000 feet below the surface of the mountain and 1,000 feet above the water table. Key engineered barriers include the solid nature of the nuclear waste; the double-shelled transportation, aging, and disposal canisters that encapsulate the waste and prevent radiation leakage; and drip shields that are composed of corrosion-resistant titanium to ward off any dripping water inside the repository for many thousands of years.

The construction of a geologic repository at Yucca Mountain would provide a permanent solution for nuclear waste that could allow the government to begin taking possession of the nuclear waste in the near term—about 10 to 30 years. The nuclear power industry sees this as an important consideration in obtaining the public support necessary to build new nuclear power reactors. The industry is interested in constructing new nuclear power reactors because, among other reasons, of the growing demand for electricity and pressure from federal and state governments to reduce reliance on fossil fuels and curtail carbon emissions. Some electric power companies see nuclear energy as an important option for noncarbon emitting power generation. According to NRC, 18 electric power companies have filed license applications to construct 29 new nuclear reactors.<sup>13</sup> Nuclear industry representatives, however, have expressed concerns that investors and the public will not support the construction of new nuclear power reactors without a final safe and secure disposition pathway for the nuclear waste, particularly if that waste is generated and stored near major waterways or urban centers. Moreover, having a permanent disposal option may allow reactor operators to thin-out spent nuclear fuel assemblies from densely packed spent fuel pools, potentially reducing the risk of harm to humans or the environment in the event of an accident, natural disaster, or terrorist event.

In addition, disposal is the only alternative for some DOE and commercial nuclear waste—even if the United States decided to reprocess the waste—because it contains nuclear waste residues that cannot be used as nuclear reactor fuel. This nuclear waste has no safe, long-term alternative other than disposal, and the Yucca Mountain repository would provide a near-term, permanent disposal pathway for it. Moreover, DOE has agreed to

---

<sup>13</sup>As of October 2, 2009, NRC had suspended or deferred five applications to build and operate six reactors at the request of the applicants.

---

remove spent nuclear fuel from at least two states by certain dates or face penalties. Specifically, DOE has an agreement with Colorado stating that if the spent nuclear fuel at Fort St. Vrain is not removed by January 1, 2035, the government will, subject to certain conditions, pay the state \$15,000 per day until the waste is removed. In addition, the state of Idaho sued DOE to remove inventories of spent nuclear fuel stored at DOE's Idaho National Laboratory. Under the resulting settlement DOE agreed to (1) remove the spent nuclear fuel by January 1, 2035, or incur penalties of \$60,000 per day and (2) curtail or suspend future shipments of spent nuclear fuel to Idaho.<sup>14</sup> Some of the spent nuclear fuel stored at the Idaho National Laboratory comes from refueling the U.S. Navy's submarines and aircraft carriers, all of which are nuclear powered. Special facilities are maintained at the Idaho National Laboratory to examine naval spent nuclear fuel to obtain information for improving future fuel performance and to package the spent nuclear fuel following examination to make it ready for rail shipment to its ultimate destination. According to Navy officials, refueling these warships, which necessitates shipment of naval spent nuclear fuel from the shipyards conducting the refuelings to the Idaho National Laboratory, is part of the Navy's national security mission. Consequently, curtailing or suspending shipments of spent nuclear fuel to Idaho raises national security concerns for the Navy.

The Yucca Mountain repository would help the government fulfill its obligation under NWPA to electric power companies and ratepayers to take custody of the commercial spent nuclear fuel and provide a permanent repository using the Nuclear Waste Fund. When DOE missed its 1998 deadline to begin taking custody of the waste, owners of spent fuel with contracts for disposal services filed lawsuits asking the courts to require DOE to fulfill its statutory and contractual obligations by taking custody of the waste. Though a court decided that it would not order DOE to begin taking custody of the waste, the courts have, in subsequent cases, ordered the government to compensate the utilities for the cost of storing the waste. DOE projected that, based on a 2020 date for beginning operations at Yucca Mountain, the government's liabilities from the 71 lawsuits filed by electric power companies could sum to about \$12.3 billion, though the outcome of pending and future litigation could

---

<sup>14</sup>The penalties in the settlement agreement specifically apply to spent nuclear fuel and not to other high-level waste. However, the agreement specifies that DOE must have the other high-level waste treated and ready for shipment out of Idaho for disposal by 2035. DOE officials acknowledged that Idaho could take further court action if its milestones toward meeting these goals are not being met.

---

substantially affect the ultimate total liability.<sup>15</sup> DOE estimates that the federal government's future liabilities will average up to \$500 million per year. Furthermore, continued delays in DOE's ability to take custody of the waste could result in additional liabilities. Some experts noted that without immediate plans for a permanent repository, reactor operators and ratepayers may demand that the Nuclear Waste Fund be refunded.<sup>16</sup>

Finally, disposing of the nuclear waste now in a repository facility would reduce the uncertainty about the willingness or the ability of future generations to monitor and maintain multiple surface waste storage facilities and would eliminate the need for any future handling of the waste. As a 2001 report of the National Academies noted, continued storage of nuclear waste is technically feasible only if those responsible for it are willing and able to devote adequate resources and attention to maintaining and expanding the storage facilities, as required to keep the waste safe and secure.<sup>17</sup> DOE officials noted that the waste packages at Yucca Mountain are designed to be retrievable for more than 100 years after emplacement, at which time DOE would begin to close the repository, allowing future generations to consider retrieving spent nuclear fuel for reprocessing or other uses. However, the risks and costs of retrieving the nuclear waste from Yucca Mountain are uncertain because planning efforts for retrieval are preliminary. Once closed, Yucca Mountain will require minimal monitoring and little or no maintenance, and all future controls will be passive.<sup>18</sup> Some experts stated that the current generation has a moral obligation to not pass on to future

---

<sup>15</sup>As of July 2009, of the 71 lawsuits filed by electric power companies, 51 cases were pending either in the Court of Federal Claims or in the Court of Appeals for the Federal Circuit, 10 had been settled, 6 were voluntarily withdrawn, and 4 had been litigated through final unappealable judgment.

<sup>16</sup>DOE estimated the Nuclear Waste Fund at about \$23 billion in June 2009, some of which is interest that has accrued. DOE is required to invest the Nuclear Waste Fund in U.S. Treasury securities, resulting in the government paying about \$11.2 billion interest to the fund. Both the principal and the interest might be returned, if the fund is returned to the electric power companies.

<sup>17</sup>National Research Council of the National Academies, *Disposition of High-Level Waste and Spent Nuclear Fuel: The Continuing Societal and Technical Challenges*, (Washington, D.C., 2001).

<sup>18</sup>Section 801 (c) of the Energy Policy Act of 1992 requires DOE to provide indefinite oversight to prevent any activity at the site that poses an unreasonable risk of (1) breaching the repository's engineered or geologic barriers or (2) increasing the exposure of the public to radiation beyond allowable limits. Pub. L. No. 102-486, 106 Stat. 2776, 2921-2922.

---

generations the extensive technical and financial responsibilities for managing nuclear waste in surface storage.

---

### Yucca Mountain Faces Many Challenges, Including a Lack of Key Support and License Approval

There are many challenges to licensing and constructing the Yucca Mountain repository, some of which could delay or potentially terminate the program. First, in March 2009, the Secretary of Energy stated that the administration planned to terminate the Yucca Mountain repository and to form a panel of experts to review alternatives. During the testimony, the Secretary stated that Yucca Mountain would not be considered as one of the alternatives. The administration's fiscal year 2010 budget request for Yucca Mountain was \$197 million, which is \$296 million less than what DOE stated it needs to stay on its schedule and open Yucca Mountain by 2020.

In July 2009 letters to DOE, the Nuclear Energy Institute and the National Association of Regulatory Utility Commissioners raised concerns that, despite the announced termination of Yucca Mountain, DOE still intended on collecting fees for the Nuclear Waste Fund.<sup>19</sup> The letters requested that DOE suspend collection of payments to the Nuclear Waste Fund. Some states have raised similar concerns and legislators have introduced legislation that could hold payments to the Nuclear Waste Fund until DOE begins operating a federal repository.<sup>20</sup>

Nevertheless, NWPA still requires DOE to pursue geologic disposal at Yucca Mountain. If the administration continues the licensing process for Yucca Mountain, DOE would face a variety of other challenges in licensing and constructing the repository. Many of these challenges—though unique to Yucca Mountain—might also apply in similar form to other future repositories, should they be considered.

One of the most significant challenges facing DOE is to satisfy NRC that Yucca Mountain meets licensing requirements, including ensuring the repository meets EPA's radiation standards over the required 1 million year time frame, as implemented by NRC regulation. For example, NRC's

---

<sup>19</sup>The Nuclear Energy Institute represents the nuclear power industry and the National Association of Regulatory Utility Commissioners represents state public utility commissions that regulate the electric power industry.

<sup>20</sup>Minnesota House File No. 894, introduced February 16, 2009, and Michigan Senate Concurrent Resolution No. 8, introduced March 25, 2009.

---

regulations require that DOE model its natural and engineered barriers in a performance assessment, including how the barriers will interact with each other over time and how the repository will meet the standards even if one or more barriers do not perform as expected. NRC has stated that there are uncertainties inherent in the understanding of the performance of the natural and engineered barriers and that demonstrating a reasonable expectation of compliance requires the use of complex predictive models supported by field data, laboratory tests, site-specific monitoring, and natural analog studies. The Nuclear Waste Technical Review Board has also stated that the performance assessment may be “the most complex and ambitious probabilistic risk assessment ever undertaken” and the Board, as well as other groups or individuals, have raised technical concerns about key aspects of the engineered or natural barriers in the repository design.

DOE and NRC officials also stated that budget constraints raise additional challenges. DOE officials told us that past budget shortfalls and projected future low budgets for the Yucca Mountain repository create significant challenges in DOE’s ability to meet milestones for licensing and for responding to NRC’s requests for additional information related to the license application. In addition, NRC officials told us budget shortfalls have constrained their resources. Staff members they originally hired to review DOE’s license application have moved to other divisions within NRC or have left NRC entirely. NRC officials stated that the pace of the license review is commensurate with funding levels. Some experts have questioned whether NRC can meet the maximum 4-year time requirement stipulated in NWPA for license review and have pointed out that the longer the delays in licensing Yucca Mountain, the more costly and politically vulnerable the effort becomes.

In addition, the state of Nevada and other groups that oppose the Yucca Mountain repository have raised technical points, site-specific concerns, and equity issues and have taken steps to delay or terminate the repository. For example, Nevada’s Agency for Nuclear Projects questioned DOE’s reliance on engineered barriers in its performance assessment, indicating that too many uncertainties exist for DOE to claim human-made systems will perform as expected over the time frames required. In addition, the agency reported that Yucca Mountain’s location near seismic and volcanic zones creates additional uncertainty about DOE’s ability to predict a recurrence of seismic or volcanic events and to assess the performance of its waste isolation barriers should those events occur some time during the 1-million-year time frame. The agency also has questioned whether Yucca Mountain is the best site compared with other

locations and has raised issues of equity, since Nevada is being asked to accept nuclear waste generated in other states. In addition to the Agency for Nuclear Projects' issues, Nevada has taken other steps to delay or terminate the project. For example, Nevada has denied the water rights DOE needs for construction of a rail spur and facility structures at Yucca Mountain. DOE officials told us that constructing the rail line or the facilities at Yucca Mountain without those water rights will be difficult.

**Based on DOE's Cost Estimates, Yucca Mountain Will Likely Cost from \$41 Billion to \$67 Billion for 153,000 Metric Tons of Nuclear Waste, but Costs Could Increase**

Our analysis of DOE's cost estimates found that (1) a 70,000 metric ton repository is projected to cost from \$27 to \$39 billion in 2009 present value over 108 years and (2) a 153,000 metric ton repository is projected to cost from \$41 to \$67 billion and take 35 more years to complete. These estimated costs include the licensing, construction, operation, and closure of Yucca Mountain for a period commensurate with the amount of waste. Table 1 shows each scenario with its estimated cost range over time.

**Table 1: Estimated Cost of the Yucca Mountain Scenarios**

| Dollars in billions              |                                  |   |
|----------------------------------|----------------------------------|---|
| Amount of nuclear waste disposed | Time period covered <sup>a</sup> | Present value estimate range <sup>a</sup> |
| 70,000 metric tons               | 2009 to 2116<br>(108 years)      | \$27 to \$39                              |
| 153,000 metric tons              | 2009 to 2151<br>(143 years)      | \$41 to \$67                              |

Source: GAO analysis based on DOE data.

<sup>a</sup>These costs are in 2009 present value and thus different than the values presented by DOE which are in constant 2007 dollars. Also, these costs do not include more than \$14 billion, in constant fiscal year 2009 dollars, that DOE spent from 1983 through 2008 for the Yucca Mountain repository. In addition, we did not include potential schedule delays and costs associated with licensing. DOE reported that each year of delay could cost DOE about \$373 million in constant 2009 dollars.

As shown in figure 4, the Yucca Mountain repository costs are expected to be high during construction, followed by reduced, but consistent costs during operations, substantially reduced costs for monitoring, then a period of increased costs for installation of the drip shields, and finally costs tapering off for closure. Once the drip shields are installed, by design, the waste packages will no longer be retrievable. After closure, Yucca Mountain is not expected to incur any significant additional costs.



**Figure 4: Cost Profile for the Yucca Mountain Repository, Assuming 70,000 Metric Tons**

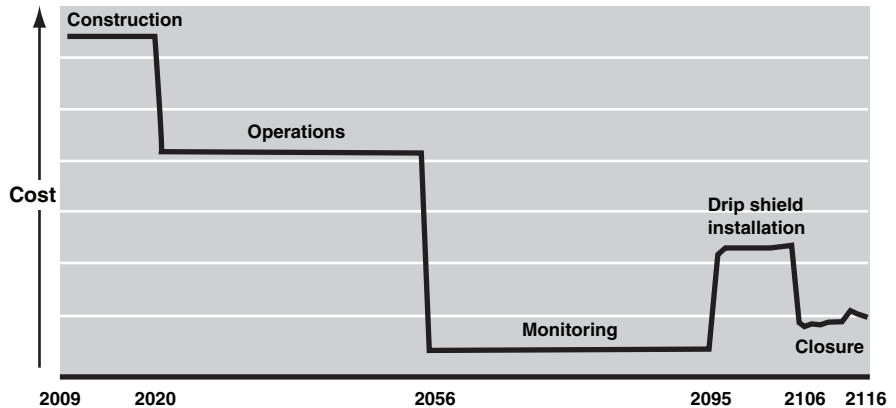

Source: GAO analysis of DOE data.

Costs for the construction of a repository, regardless of location, could increase based on a number of different scenarios, including delays in license application, funding shortfalls, and legal or technical issues that cause delays or changes in plans. For example, we asked DOE to assess the cost of a year's delay in license application approval from the current 3 years to 4 years, the maximum allowed by NWP. DOE officials told us that each year of delay would cost DOE about \$373 million in constant 2009 dollars. Although the experts with whom we consulted did not agree on how long the licensing process for Yucca Mountain might take, several experts told us that the 9 years it took Private Fuel Storage to obtain its license was not unreasonable. This licensing time frame may not directly apply to the Yucca Mountain repository because the repository has a significantly different licensing process and regulatory scheme, including extensive pre-licensing interactions, a federal funding stream, and an extended compliance period and, because of the uncertainties, could take shorter or longer than the Private Fuel Storage experience. A nine-year licensing process for construction authorization would add an estimated \$2.2 billion to the cost of the repository, mostly in costs to maintain current systems, such as project support, safeguards and security, and its licensing support network. In addition to consideration of the issuance of a construction authorization, NRC's repository licensing process involves two additional licensing actions necessary to operate and close a repository, each of which allows for public input and could potentially adversely affect the schedule and cost of the repository. The second action is the consideration of an updated DOE application for a license to receive and possess high-level radioactive waste. The third action is the

---

consideration of a DOE application for a license amendment to permanently close the repository. Costs could also increase if unforeseen technical issues developed. For example, some experts told us that the robotic emplacement of waste packages could be difficult because of the heat and radiation output from the nuclear waste, which could impact the electronics on the machinery. DOE officials acknowledged the challenges and told us the machines would have to be shielded for protection. They noted, however, that industry has experience with remote handling of shielded robotic machinery and DOE should be able to use that experience in developing its own machinery.

The responsibility for Yucca Mountain's costs would come from the Nuclear Waste Fund and taxpayers through annual appropriations. NWPA created the Nuclear Waste Fund as a mechanism for the nuclear power industry to pay for its share of the cost for building and operating a permanent repository to dispose of nuclear waste. NWPA also required the federal taxpayers to pay for the portion of permanent repository costs for DOE-managed spent nuclear fuel and high-level waste. DOE has responsibility for determining on an annual basis whether fees charged to industry to finance the Nuclear Waste Fund are sufficient to meet industry's share of costs. As part of that process, DOE developed a methodology in 1989 that uses the total system life cycle cost estimate as input for determining the shares of industry and the federal government by matching projected costs against projected assets. The most recent published assessment, published in July 2008, showed that 80.4 percent of the disposal costs would come from the Nuclear Waste Fund and 19.6 percent would come from appropriations for the DOE-managed spent nuclear fuel and high-level waste.

In addition, the Department of the Treasury's judgment fund will pay the government's liabilities for not taking custody of the nuclear waste in 1998, as required by DOE's contract with industry. Based on existing judgments and settlements, DOE has estimated these costs at \$12.3 billion through 2020 and up to \$500 million per year after that, though the outcome of pending litigation could substantially affect the government's ultimate liability. The Department of Justice has also spent about \$150 million to defend DOE in the litigation.

---

## We Identified Two Nuclear Waste Management Alternatives and Developed Cost Models by Consulting with Experts

We used input from experts to identify two nuclear waste management alternatives that could be implemented if the nation does not pursue disposal at Yucca Mountain—centralized storage and continued on-site storage, both of which could be implemented with final disposal, according to experts. To understand the implications and likely assumptions of each alternative, as well as the associated costs for the component parts, we systematically solicited facts, advice, and opinions from experts in nuclear waste management. Finally, we used the data and assumptions that the experts provided to develop large-scale cost models that estimate ranges of likely total costs for each alternative.

---

## We Consulted with Experts to Identify and Develop Assumptions for Two Generic Alternatives to Analysis

To identify waste management alternatives that could be implemented if the waste is not disposed of at Yucca Mountain, we solicited facts, advice, and opinions from nuclear waste management experts. Specifically, we interviewed dozens of experts from DOE, NRC, the Nuclear Energy Institute, the National Association of Regulatory Utility Commissioners, the National Conference of State Legislatures, and the State of Nevada Agency for Nuclear Projects. We also reviewed documents they provided or referred us to.

Based on this information, we chose to analyze (1) centralized interim dry storage and (2) on-site dry storage (both interim and long-term). Centralized storage has been attempted to varying degrees in the United States, and on-site storage has become the country's status quo. Consequently, the experts believe these two alternatives are currently among the most likely for this country in the near-term, in conjunction with final disposal in the long-term. The experts also told us that current nuclear waste reprocessing technologies raise proliferation concerns and are not considered commercially feasible, but they noted that reprocessing has future potential as a part of the nation's nuclear waste management strategy. Because nuclear waste is not reprocessed in this country, we found a lack of sufficient and reliable data to provide meaningful analysis for this alternative. Experts have largely dismissed other alternatives that have been identified, such as disposal of waste in deep boreholes, because of cost or technical constraints.

We developed a set of key assumptions to establish the scope of our alternatives by initially consulting with a small group of nuclear waste management experts. For example, we asked the experts about how many storage sites should be used and whether waste would have to be repackaged. These discussions occurred in an iterative manner—we followed up with experts with specific expertise to refine our assumptions

as we learned more. Based on this input, we formulated several key assumptions and defined the alternatives in a generic manner by taking into account some, but not all, of the complexities involved with nuclear waste management (see table 2). We made this choice because experts advised us that trying to consider all of the variability among reactor sites would result in unmanageable models since each location where nuclear waste is currently stored has a unique set of environmental, management, and regulatory considerations that affect the logistics and costs of waste management. For example, reactor sites use different dry cask storage systems with varying costs that require different operating logistics to load the casks.

**Table 2: Key Assumptions Used to Define Alternatives**

| <b>Centralized storage</b>                             |  |
|--|--|
| Type of storage  | Conventional dry cask storage (for commercial spent nuclear fuel).   |
| Number of sites  | Two centralized interim storage sites, located in different geographic regions of the country.   |
| Reactor operations                                     | All currently operating reactors receive a 20-year license extension and continue operating until the extensions expire.<br>Reactors will be decommissioned when operations cease, and only spent nuclear fuel dry storage will remain on site.  |
| Transportation   | Transportation to the centralized site will be via rail using dedicated trains.  |
| Repackaging  | Waste will not be repackaged at the centralized facilities.  |
| Final disposition <sup>a</sup>                         | After 100 years, the waste will be disposed of in a geologic repository.   |
| <b>On-site storage</b>                                 |  |
| Type of storage  | Conventional dry cask storage (for commercial spent nuclear fuel).   |
| Number of sites  | Commercial spent nuclear fuel will be stored on independent spent fuel storage installations at 75 reactor sites, which includes operating reactor sites, decommissioned reactor sites, and the Morris facility. <sup>b</sup><br>DOE high-level waste and spent nuclear fuel will remain at five current sites. <sup>c</sup><br>DOE spent nuclear fuel will be moved to dry storage. DOE high-level waste will be vitrified and stored in facilities like the Glass Waste Storage Building at the Savannah River Site. |
| Reactor operations                                     | All currently operating reactors receive a 20-year license extension and continue operating until the extensions expire.<br>Reactors will be decommissioned when operations cease, and only spent nuclear fuel dry storage will remain on site.  |
| Transportation   | Waste will not be transported between reactor sites.   |
| Repackaging  | Dry cask storage systems will need to be replaced after 100 years, requiring repackaging into new inner canisters and outer casks. Only our 500-year on-site storage model assumes repackaging.  |
| Final disposition or long-term management <sup>c</sup> | We analyzed two final disposition scenarios: The waste will be disposed of in a geologic repository after 100 years or the waste will remain on site for 500 years and be repackaged every 100 years.  |

Source: GAO analysis based on expert-provided data.

<sup>a</sup>We analyzed some scenarios associated with these alternatives that did not include final disposition of the waste.

---

<sup>5</sup>The Morris facility is an independent spent nuclear fuel storage installation located in Illinois that is operated by General Electric Corporation, which originally intended to operate a fuel reprocessing plant at the site. The Morris facility is the only spent nuclear fuel pool licensed by NRC that is not at a reactor site.

<sup>6</sup>Hanford Reservation, Washington; Idaho National Laboratory, Idaho; Fort St. Vrain, Colorado; West Valley, New York; and Savannah River Site, South Carolina.

In addition, there were some instances in which we made assumptions that, while not entirely realistic, were necessary to keep our alternatives generic and distinct from one another. For example, some electric power companies would likely consolidate nuclear waste from different locations by transporting it between reactor sites, but to keep the on-site storage alternative generic and distinct from the centralized storage alternative, we assumed that there would be no consolidation of waste. These simplifying assumptions make our alternatives hypothetical and not entirely representative of their real-world implementation.

We also consulted with experts to formulate more specific assumptions about processes that reflect the sequence of activities that would occur within each alternative (see fig. 5). In addition, we identified the components of these processes that have associated costs. For example, one of the processes associated with both alternatives is packaging the nuclear waste in dry storage canisters from the pools of water where they are stored. The component costs associated with this process include the dry storage canisters and operations to load the spent nuclear fuel into the canisters.

**Figure 5: Process Assumptions and Cost Components for Hypothetical Nuclear Waste Management Alternatives**

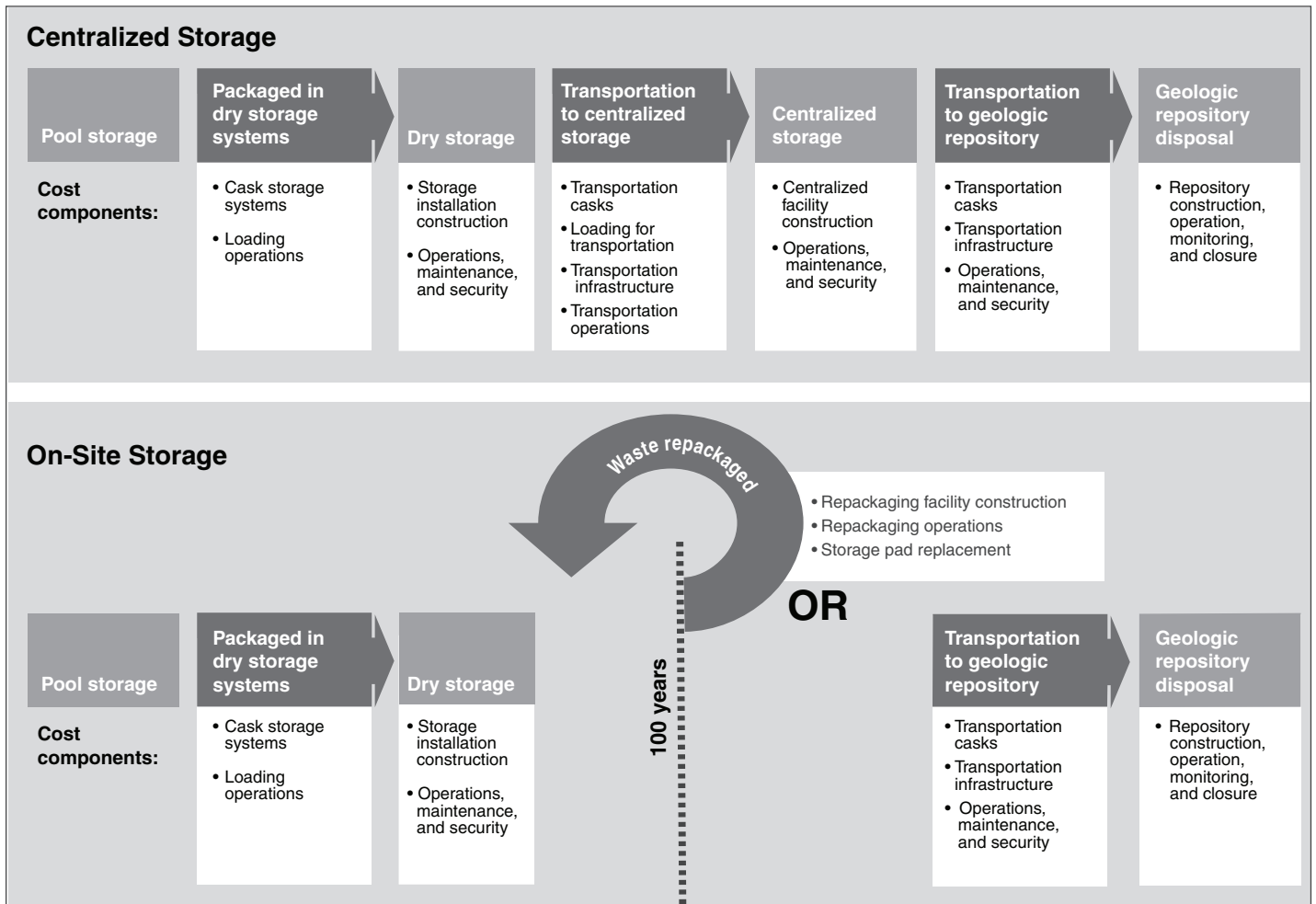

Source: GAO analysis based on expert-provided data.

We then began to gather data on specific processes and component costs, such as the kind of cask systems we would use in our model and their cost. We gathered initial data from a core group of experts with specialized knowledge in different aspects of nuclear waste management, such as cask systems, waste loading operations, and transportation. We then solicited comments on the initial data from a broader group of experts using a data collection instrument that asked specific questions about how reasonable the data were. We received almost 70 sets of comments and used them to refine or modify our assumptions and component costs and develop the input data that we would use to estimate

---

the overall costs of the alternatives. (See app. I for additional information about our scope and methodology, app. II for our methodology for soliciting comments from nuclear waste management experts, and app. III for these experts.)

---

### We Developed Cost Ranges for Each Alternative Using Large-scale Cost Models that Addressed Uncertainties and Discounted Future Costs

To generate cost ranges for the centralized storage and on-site storage alternatives, we developed four large-scale cost models that analyzed the costs for each alternative of storing 70,000 metric tons and 153,000 metric tons of nuclear waste and created scenarios within these models to analyze different storage durations and final dispositions. (See table 3.) We generated cost ranges for each alternative for storing 153,000 metric tons of waste for 100 years followed by disposal in a geologic repository. We also generated cost ranges for each alternative of storing 70,000 metric tons and 153,000 metric tons of nuclear waste for 100 years, and for storing 153,000 metric tons of waste on site for 500 years without including the cost of subsequent disposal in a geologic repository. For each of the models, which rely upon data and assumptions provided by nuclear waste management experts, the cost range was based on the annual volume of commercial spent nuclear fuel that became ready to be packaged and stored in each year.<sup>21</sup> In general, each model started in 2009 by annually tracking costs of initial packaging and related costs for the first 100 years and for every 100 years thereafter if the waste was to remain on site and be repackaged. Since our models analyzed only the costs associated with storing commercial nuclear waste management, we augmented them with DOE's cost data for (1) managing its spent nuclear fuel and high-level waste and (2) constructing and operating a permanent repository. Specifically, we used DOE's estimated costs for the Yucca Mountain repository to represent cost for a hypothetical permanent repository.<sup>22</sup>

---

<sup>21</sup>NWPA caps the amount of nuclear waste that can be disposed of at Yucca Mountain at 70,000 metric tons. The estimated amount of current waste plus additional commercial spent nuclear fuel that would be generated if all currently operating commercial reactors received license extensions is 153,000 metric tons. Our analysis did not consider new reactors because of the uncertainty if or when new reactors would be built, how many would be built, and their impact on waste streams.

<sup>22</sup>We excluded historical costs for the Yucca Mountain repository because these costs represent challenges unique to Yucca Mountain and may not be applicable to a future repository. However, the bulk of future cost for construction, operation, and closure may be representative of a new repository.

**Table 3: Models and Scenarios Used for Cost Ranges**

| Model                                |                            | Scenario                 |   |
|--------------------------------------|----------------------------|--------------------------|---|
| Nuclear waste management alternative | Waste volume (metric tons) | Storage duration (years) | Final disposition or long-term management |
| On-site storage                      | 153,000                    | 100                      | None                                      |
|                                      |                            | 100                      | Permanent repository                      |
|                                      |                            | 500                      | Waste repackaged every 100 years          |
| On-site storage                      | 70,000                     | 100                      | None                                      |
| Centralized storage                  | 153,000                    | 100                      | None                                      |
|                                      |                            | 100                      | Permanent repository                      |
| Centralized storage                  | 70,000                     | 100                      | None                                      |

Source: GAO analysis.

One of the inherent difficulties of analyzing the cost of any nuclear waste management alternative is the large number of uncertainties that need to be addressed. In addition to general uncertainty about the future, there is uncertainty because of the lack of knowledge about the waste management technologies required, the type of waste and waste management systems that individual reactors will eventually employ, and cost components that are key inputs to the models and could occur over hundreds or thousands of years. Given these numerous uncertainties, it is not possible to precisely determine the total costs of each alternative. However, much of the uncertainty that we could not easily capture within our models can be addressed through the use of several alternative models and scenarios. As shown in table 3, we developed two models for each alternative to address the uncertainty regarding the total volume of waste for disposal. We then developed different scenarios within each model to address different time frames and disposal paths. Furthermore, we used a risk analysis modeling technique that recognized and addressed uncertainties in our data and assumptions. Given the different possible scenarios and uncertainties, we generated ranges, rather than point estimates, for analyzing the cost of each alternative.

One of the most important uncertainties in our analysis was uncertainty over component costs. To address this, we used a commercially available risk analysis software program that enabled us to model specific



---

uncertainties associated with a large number of cost inputs and assumptions. Using a Monte Carlo simulation process,<sup>23</sup> the program explores a wide range of values, instead of one single value, for each cost input and estimates the total cost. By repeating the calculations thousands of times with a different set of randomly chosen input values, the process produces a range of total costs for each alternative and scenario. The process also specifies the likelihood associated with values in the estimated range.

Another inherent difficulty in estimating the cost of nuclear waste management alternatives is the fact that the costs are spread over hundreds or thousands of years. The economic concept of discounting is central to such long-term analysis because it allows us to convert costs that occur in the distant future to present value—equivalent values in today’s dollars. Although the concept of discounting is an accepted and standard methodology in economics, the concept of discounting values over a very distant future—known as “intergenerational discounting”—is still subject to considerable debate. Furthermore, no consensus exists among economists regarding the exact value of the discount rate that should be used to discount values that are spread over many hundreds or thousands of years.

To develop an appropriate discounting methodology and to choose the discount rates for our analysis, we reviewed a number of economic studies published in peer-reviewed journals that addressed intergenerational discounting. Based on our review, we designed a discounting methodology for use in our models. Because our review did not find a consensus on discount rates, we used a range of values for discount rates that we developed based on the economic studies we reviewed, rather than using one single rate. Consequently, because we used ranges for the discount rate along with the Monte Carlo simulation process, the present value of estimated costs does not depend on one single discount rate, but rather reflect a range of discount rate values taken from peer-reviewed studies. (See app. IV for details of our modeling and discounting methodologies, assumptions, and results.)

---

<sup>23</sup>We used a commercially available risk analysis program called Crystal Ball for our Monte Carlo simulation. Crystal Ball is a commonly used spreadsheet-based software for predictive modeling and forecasting.

---

## Centralized Storage Would Provide a Near-Term Alternative, Allowing Other Options to Be Studied, but Faces Implementation Challenges

Centralized storage would provide a near-term alternative for managing nuclear waste, allowing the government to begin taking possession of the waste within approximately the next 30 years, and giving additional time for the nation to consider long-term waste management options. However, centralized storage does not preclude the need for final disposal of the waste. In addition, centralized storage faces several implementation challenges including that DOE (1) lacks statutory authority to provide centralized storage under NWPA, (2) is expected to have difficulty finding a location willing to host a centralized storage facility, and (3) faces potential transportation risks. The estimated cost of implementing centralized storage for 100 years ranges from \$15 billion to \$29 billion for 153,000 metric tons of nuclear waste, and the total cost ranges from \$23 billion to \$81 billion if the nuclear waste is centrally stored and then disposed in a geologic repository.

---

## Centralized Storage Would Provide a Near-Term Alternative to Managing Nuclear Waste but Does Not Eliminate the Need for Final Disposal

As the administration re-examines the Yucca Mountain repository and national nuclear waste policy, centralized dry cask storage could provide a near-term alternative for managing the waste that has accumulated and will continue to accumulate. This would provide additional time—NRC has stated that spent nuclear fuel storage is safe and environmentally acceptable for a period on the order of 100 years—to consider other long-term options that may involve alternative policies and new technologies and allow some flexibility for their implementation. For example, centralized storage would maintain nuclear waste in interim dry storage configurations so that it could be easily accessible for reprocessing in case the nation decided to pursue reprocessing as a waste management option and developed technologies that address current proliferation and cost concerns. In fact, reprocessing facilities could be built near or adjacent to centralized facilities to maximize efficiencies. However, even with reprocessing, some of the spent nuclear fuel and high-level waste in current inventories would require final disposal.

Centralized storage would consolidate the nation's nuclear waste after reactors are decommissioned, thereby decreasing the complexity of securing and overseeing the waste and increasing the efficiency of waste storage operations. This alternative would remove nuclear waste from all DOE sites and nine shutdown reactor sites that have no operations other than nuclear waste storage, allowing these sites to be closed. Some of these storage sites occupy land that potentially could be used for other purposes, imposing an opportunity cost on states and communities that no longer receive the benefits of electricity generation from the reactors. To compensate for this loss, industry officials noted that at least two states

---

where decommissioned sites are located have tried to raise property taxes on the sites, and at one site, the state collects a per cask fee for storage. In addition, the continued storage of nuclear waste at decommissioned sites can cost the power companies between about \$4 million and \$8 million per year, according to several experts.

Centralized storage could allow reactor operators to thin-out spent nuclear fuel assemblies from densely packed spent fuel pools and may also prevent operating reactors from having to build the additional dry storage capacity they would need if the nuclear waste remained on site. According to an industry official, 28 reactor sites could have to add dry storage facilities over the next 10 years in order to maintain a desired capacity in their storage pools. These dry storage facilities could cost about \$30 million each, but this cost would vary widely by site. In addition, some current reactor sites use older waste storage systems and are near large cities or large bodies of fresh water used for drinking or irrigation. Although NRC's licensing and inspection process is designed to ensure that these existing facilities appropriately protect public health and safety, new centralized facilities could use state-of-the-art design technology and be located in remote areas with fewer environmental hazards, in order to protect public health and enhance safety.

Finally, if DOE uses centralized facilities to store commercial spent nuclear fuel, this alternative could allow DOE to fulfill its obligation to take custody of the commercial spent nuclear fuel until a long-term strategy is implemented. As a result, DOE could curtail its liabilities to the electric power companies, potentially saving the government up to \$500 million per year after 2020, as estimated by DOE. The actual impact of centralized storage on the amount of the liabilities would depend on several factors, including when centralized storage is available, whether reactor sites had already built on-site dry storage facilities for which the government may be liable for a portion of the costs, how soon waste could be transported to a centralized site, and the outcome of pending litigation that may affect the government's total liability. DOE estimates that if various complex statutory, regulatory, siting, construction, and financial issues were expeditiously resolved, a centralized facility to accept nuclear waste could begin operations as early as 6 years after its development began. However, a centralized storage expert estimated that the process from site selection until a centralized facility opens could take between 17 and 33 years.

Although centralized storage has a number of positive attributes, it provides only an interim alternative and does not eliminate the need for

---

final disposal of the nuclear waste. To keep the waste safe and secure, a centralized storage facility relies on active institutional controls, such as monitoring, maintenance, and security. Over time, the storage systems may degrade and institutional controls may be disrupted, which could result in increased risk of radioactive exposure to humans or the environment. For example, according to several experts on dry cask systems, the vents on the casks—which allow for passive cooling—must be periodically inspected to ensure no debris clogs them, particularly during the first several decades when the spent nuclear fuel is thermally hot. If the vents become clogged, the temperature in the canister could rise, which could impact the life of the dry cask storage system. Over a longer time frame, concrete on the exterior casks could degrade, requiring more active maintenance. Although some experts stated that the risk of radiation being released into the environment may be low, such risks can be avoided by permanently isolating the waste in a manner that does not require indefinite, active institutional controls, such as disposal in a geologic repository.

---

### Legal and Community Challenges Contribute to the Complexity of Implementing Centralized Storage

A key challenge confronting the centralized storage alternative is the lack of authority under NWPA for DOE to provide such storage. Provisions in NWPA that allow DOE to arrange for centralized storage have either expired or are unusable because they are tied to milestones in repository development that have not been met. For example, NWPA authorized DOE to provide temporary storage for a limited amount of spent nuclear fuel until a repository was available, but this authority expired in 1990. Some industry representatives have stated that DOE still has the authority to accept and store spent nuclear fuel under the Atomic Energy Act of 1954, as amended, but DOE asserts that NWPA limits its authority under the Atomic Energy Act.<sup>24</sup> In addition, NWPA provided authority for DOE to site, construct, and operate a centralized storage facility, but such a facility could not be constructed until NRC authorized construction of the Yucca Mountain repository, and the facility could only store up to 10,000 metric

---

<sup>24</sup>DOE acknowledged that the Atomic Energy Act of 1954, as amended, does provide the authority for DOE to accept and store spent nuclear fuel under certain circumstances, which DOE has used in the past to accept and store spent nuclear fuel. For example, pursuant to the Atomic Energy Act authority, DOE has accepted and stored U.S.-supplied spent nuclear fuel from foreign reactors, as well as damaged spent nuclear fuel from the Three Mile Island reactor site. However, DOE asserts that the NWPA's detailed statutory scheme limits its authority to accept spent nuclear fuel under Atomic Energy Act authority except in compelling circumstances, such as an emergency involving spent nuclear fuel threatening public health.

---

tons of nuclear waste until the repository started accepting spent nuclear fuel. Therefore, unless provisions in NWPA were amended, centralized storage would have to be funded, owned, and operated privately. A privately operated centralized storage facility alternative, such as the proposed Private Fuel Storage Facility in Utah, would not likely resolve DOE's liabilities with the nuclear power companies.<sup>25</sup>

A second, equally important, challenge to centralized storage is the likelihood of opposition during site selection for a facility. Experts noted that affected states and communities would raise concerns about safety, security, and the likelihood that an interim centralized storage facility could become a de facto permanent storage site if progress is not being made on a permanent repository. Even if a local community supports a centralized storage facility, the state may not. For example, the Private Fuel Storage facility was generally supported by the Skull Valley Band of the Goshute Indians, on whose reservation the facility was to be located, but the state of Utah and some tribal members opposed its licensing and construction. Other states have indicated their opposition to involuntarily hosting a centralized facility through means such as the Western Governors' Association, which issued a resolution stating that "no such facility, whether publicly or privately owned, shall be located within the geographic boundaries of a Western state without the written consent of the governor."<sup>26</sup> Some experts noted that a state or community may be willing to serve as a host if substantial economic incentives were offered and if the party building the site undertook a time-consuming and expensive process of site characterization and safety assessment. However, DOE officials stated that in their previous experience—such as with the Nuclear Waste Negotiator about 15 to 20 years ago—they have found no incentive package that has successfully encouraged a state to voluntarily host a site.

A third challenge to centralized storage is that nuclear waste would likely have to be transported twice—once to the centralized site and once to a permanent repository—if a centralized site were not colocated with a

---

<sup>25</sup>In addition, lawsuits filed against the government by nuclear reactor owners have included claims to recover the cost of the Private Fuel Storage facility. At least one utility has recovered these costs from the government, while a court did not allow another utility to recover these costs.

<sup>26</sup>Western Governors' Association Policy Resolution 09-5: Interim Storage and Transportation of Commercial Spent Nuclear Fuel.

---

repository.<sup>27</sup> Therefore, the total distance over which nuclear waste is transported is likely to be greater than with other alternatives, an important factor because, according to one expert, transportation risk is directly tied to this distance. However, according to DOE, nuclear waste has been safely transported in the United States since the 1960s and National Academy of Sciences, NRC, and DOE-sponsored reports have found that the associated risks are well understood and generally low. Yet, there are also perceived risks associated with nuclear waste transportation that can result in lower property values along transportation routes, reductions in tourism, and increased anxiety that create community opposition to nuclear waste transportation. According to experts, transportation risks could be mitigated through such means as shipping the least radioactive fuel first, using trains that only transport nuclear waste, and identifying routes that minimize possible impacts on highly populated areas. In addition, the hazards associated with transportation from a centralized facility to a repository would decline as the waste decayed and became less radioactive at the centralized facility.

---

### Cost Ranges for Centralized Storage Will Vary Depending on Waste Volume and Final Disposition

As shown in table 4, our models generated cost ranges from \$23 billion to \$81 billion for the centralized storage of 153,000 metric tons of spent nuclear fuel and high-level waste for 100 years followed by geologic disposal. For centralized storage without disposal, costs would range from \$12 billion to \$20 billion for 70,000 metric tons of waste and from \$15 billion to \$29 billion for 153,000 metric tons of waste. These centralized model scenarios include the cost of on-site operations required to package and prepare the waste for transportation, such as storing the waste in dry-cask storage until it is transported off site, developing and operating a system to transport the waste to centralized storage, and constructing and operating two centralized storage facilities. (See app. IV for information about our modeling methodology, assumptions, and results.)

---

<sup>27</sup>NWPA prohibits development of a centralized storage facility in any state where a site is being characterized for development of a repository.

**Table 4: Estimated Cost Range for Each Centralized Storage Scenario**

| Dollars in billions   |   |                                   |
|---|---|-----------------------------------|
| Centralized storage scenario  | Time period covered <sup>a</sup>          | 2009 present value estimate range |
| Storage of 70,000 metric tons   | 2009 to 2108<br>(100 years)               | \$12 to \$20                      |
| Storage of 153,000 metric tons  | 2009 to 2108<br>(100 years)               | \$15 to \$29                      |
| Storage of 153,000 metric tons, with disposal in a permanent repository after 100 years | 2009 to 2240<br>(232 years <sup>b</sup> ) | \$23 to \$81                      |

Source: GAO analysis of data provided by nuclear waste management experts and DOE.

<sup>a</sup>See appendix IV for an explanation of the periods covered by the scenarios.

<sup>b</sup>This period was chosen to capture costs of the hypothetical geologic repository through closure.

Actual centralized storage costs may be more or less than these cost ranges if a different centralized storage scenario is implemented. For example, our models assume that there would be two centralized facilities, but licensing, construction, and operations and maintenance costs would be greater if there were more than two facilities and lower if there was only one facility. Some experts told us that centralized storage would likely be implemented with only one facility because it would be too difficult to site two. But other experts noted that having more sites could reduce the number of miles traveled by the waste and provide a greater degree of geographic equity. The length of time the nuclear waste is stored could also impact the cost ranges, particularly if the nuclear waste were stored for less than or more than the time period assumed in our model. For periods longer than 100 years, experts told us that the dry storage cask systems may be subject to degradation and require repackaging, substantially raising the costs, as well as the level of uncertainty in those costs. Transportation is another area where costs could vary if, for example, transportation was not by rail or if the transportation system differed significantly from what is assumed in our models.

Furthermore, costs could be outside our ranges if the final disposition of the waste is different. Our scenario that includes geologic disposal is based on the current cost projections for Yucca Mountain, but these costs could be significantly different for another repository site or if much of the nuclear waste is reprocessed. A different geologic repository would have unique site characterization costs, may use an entirely different design than Yucca Mountain, and may be more or less difficult to build. Also, reprocessing could contribute significantly to the cost of an alternative.

---

For example, we previously reported that construction of a reprocessing plant with an annual production throughput of 3,000 metric tons of spent nuclear fuel could cost about \$44 billion.<sup>28</sup> Studies analyzed by the Congressional Budget Office estimate that once a reprocessing plant is constructed, spent nuclear fuel could be reprocessed at between \$610,000 and \$1.4 million per-metric-ton, when adjusted to 2009 constant dollars.<sup>29</sup> This would result in an annual cost of about \$2 billion to \$4 billion, assuming a throughput of 3,000 metric tons per year.

Finally, the actual cost of implementing one of our centralized storage scenarios would likely be higher than our estimated ranges indicate because our models omit several location-specific costs. These costs could not be quantified in our generic models because we did not make an assumption about the specific location of the centralized facilities. For example, a few experts noted that incentives may be given a state or locality as a basis for allowing a centralized facility to be built, but the incentive amount may vary from location to location based on what agreement is reached. Also, several experts said that rail construction may be required for some locations, which could add significant cost depending on the distance of new rail line required at a specific location. Experts could not provide data for these location-dependent costs to any degree of certainty, so we did not use them in our models. Also, the funding source for government-run centralized storage is unclear. The Nuclear Waste Fund, which electric power companies pay into, was established by NWPA to fund a permanent repository and cannot be used to pay for centralized storage without amending the act. Without such a change, the cost for the federal government to implement this alternative would likely have to be borne by the taxpayers.

---

<sup>28</sup>GAO, *Global Nuclear Energy Partnership: DOE Should Reassess Its Approach to Designing and Building Spent Nuclear Fuel Recycling Facilities*, [GAO-08-483](#) (Washington, D.C.: April 2008).

<sup>29</sup>The studies used in the Congressional Budget Office's analysis were: Boston Consulting Group, *Economic Assessment of Used Nuclear Fuel Management in the United States* (study prepared for AREVA Inc., July 2006); and Matthew Bunn and others, *The Economics of Reprocessing vs. Direct Disposal of Spent Nuclear Fuel*, Belfer Center for Science and International Affairs, John F. Kennedy School of Government, Harvard University, (Cambridge, Massachusetts, December 2003).



---

## On-Site Storage Would Provide an Intermediate Option with Minimal Effort but Poses Challenges that Could Increase Over Time

On-site storage of nuclear waste provides an intermediate option to manage the waste until the government can take possession of it, requiring minimal effort to change from what the nation is currently doing to manage its waste. In the meantime, other longer term policies and strategies could be considered. Such strategies would eventually be required because the on-site storage alternative would not eliminate the need for final disposal of the waste. Some experts believe that legal, community, and technical challenges associated with on-site storage will intensify as the waste remains on site without plans for final disposition because, for example, communities are more likely to oppose recertification of on-site storage. The estimated cost to continue storing 153,000 metric tons of nuclear waste on site for 100 years range from \$13 billion to \$34 billion, and total costs would range from \$20 billion to \$97 billion if the nuclear waste is stored on site for 100 years and then disposed in a geologic repository.

---

## On-Site Storage Would Require Minimal Near-Term Logistics and Provide Time to Decide on Long-Term Waste Management Strategies

Because of delays in the Yucca Mountain repository, on-site storage has continued as the nation's strategy for managing nuclear waste, thus its continuation would require minimal near-term effort and allow time for the nation to consider alternative long-term nuclear waste management options. This alternative maintains the waste in a configuration where it is readily retrievable for reprocessing or other disposition, according to an expert. However, like centralized storage, on-site storage is an interim strategy that relies on active institutional controls, such as monitoring, maintenance, and security. To permanently isolate the waste from humans and the environment without the need for active institutional controls some form of final disposal would be required, even if some of the waste were reprocessed.

The additional time in on-site storage may also make the waste safer to handle because older spent nuclear fuel and high-level waste has had a chance to cool and become less radioactive. As a result, on-site storage could reduce transportation risks, particularly in the near-term, since the nuclear waste would be cooler and less radioactive when it is finally transported to a repository. In addition, some experts state that older, cooler waste may provide more predictability in repository performance and be some degree safer than younger, hotter waste. However, NRC cautioned that the ability to handle the waste more safely in the future also depends on other factors, including how the waste or waste packages might degrade over time. In particular, NRC stated that there are many uncertainties with the behavior of spent nuclear fuel as it ages, such as potential fracturing of the structural assemblies, possibly increasing the

---

risks of release. If the waste has to be repackaged, for example, the process may require additional safety measures. Some experts noted that continuing to store nuclear waste on site would be more equitable than consolidating it in one or a few areas. As a result, the waste, along with its associated risks, would be kept in the location where the electrical power was generated, leaving the responsibility and risks of the waste in the communities that benefited from its generation.

---

### On-Site Storage Poses Legal, Community, and Technical Challenges that Are Likely to Intensify over Time

With on-site storage of DOE-managed spent nuclear fuel and high-level waste, DOE would have difficulty meeting enforceable agreements with states, which could result in significant costs being incurred the longer spent nuclear fuel remains on site. In addition to Idaho's agreement to impose a penalty of \$60,000 per day if spent nuclear fuel is not removed from the state by 2035, DOE has an agreement with Colorado stating that if the spent fuel at Fort St. Vrain is not removed by January 1, 2035, the government will, subject to certain conditions, pay the state \$15,000 per day until it is removed. Other states where DOE spent nuclear fuel and high-level waste are currently stored may seek similar penalties if the spent fuel and waste remain on-site with no progress toward a permanent repository or centralized storage facility.

A second challenge is the cost due to the government's possible legal liabilities to commercial reactor operators. Leaving waste on site under the responsibility of the electric power companies does not relieve the government of its obligation to take custody of the waste, thus the liability debt could continue to mount. For every year after 2020 that DOE fails to take custody of the waste in accordance with its contracts with the reactor operators, DOE estimates that the government will continue to accumulate up to \$500 million per year beyond the estimated \$12 billion in liabilities that will have accrued up to that point; however, the outcome of pending litigation could substantially affect the government's total liability.<sup>30</sup> The government will no longer incur these costs if DOE takes custody of the waste. Some representatives from industry have stated that it is not practical for DOE to take custody of the waste at commercial reactor sites. Moreover, some electric power company executives have stated that their ratepayers are paying for DOE to provide a geologic repository through

---

<sup>30</sup>Legislative action by the Congress could also affect the amount of compensation the government ultimately pays to the reactor operators. For example, the Congress could amend NWPA to change contract provisions that would be applicable to newly constructed reactors.

---

their contributions to the Nuclear Waste Fund, and the executives believe that simply taking custody of the waste is not sufficient. A DOE official stated that if DOE were to take custody of the waste on site, it would be a complex undertaking due to considerations such as liability for accidents.

Third, continued use of on-site storage would likely also face community opposition. Some experts noted that without progress on a centralized storage facility or repository site to which waste will be moved, some state and local opposition to reactor storage site recertification will increase, and so will challenges to nuclear power companies' applications for reactor license extensions and combined licenses to construct and operate new reactors. Also, experts noted that many commercial reactor sites are not suitable for long-term storage, and none has had an environmental review to assess the impacts of storing nuclear waste at the site beyond the period for which it is currently licensed. One expert noted that if on-site storage were to become a waste management policy, the long-term health, safety, and environmental risks at each site would have to be evaluated. Because waste storage would extend beyond the life of nuclear power reactors, decommissioned reactor sites would not be available for other purposes, and the former reactor operators may have to stay in business for the sole purpose of storing nuclear waste.

Finally, although dry cask storage is considered reliable in the short term, the longer-term costs, maintenance requirements, and security requirements are not well understood. Many experts said waste packages will likely retain their integrity for at least 100 years, but eventually dry storage systems may begin to degrade and the waste in those systems would have to be repackaged. However, commercial dry storage systems have only been in existence since 1986, so nuclear utilities have little experience with long-term system degradation and requirements for repackaging. Some experts suggested that only the outer protective cask would require replacement, but the inner canister would not have to be replaced. Yet, other experts said that, over time, the inner canister would also be exposed to environmental conditions by vents in the outer cask, which could cause corrosion and require a total system replacement. In addition, experts disagreed on the relative safety risks and costs associated with using spent fuel pools to transfer the waste during repackaging compared to using a dry transfer system, which industry representatives said had not been used on a commercial scale. Finally, future security requirements for extended storage are uncertain because as spent nuclear waste ages and becomes cooler and less radioactive, it becomes less lethal to anyone attempting to handle it without protective shielding. For example, a spent nuclear fuel assembly can lose nearly 80

percent of its heat 5 years after it has been removed from a reactor, thereby reducing one of the inherent deterrents to thieves and terrorists attempting to steal or sabotage the spent nuclear fuel and potentially creating a need for costly new security measures.

**Cost Ranges for On-Site Storage Will Vary Depending on Waste Volume, Final Disposition, and Duration of Storage**

As shown in table 5, our models generated cost ranges from \$20 billion to \$97 billion for the on-site storage of 153,000 metric tons of spent nuclear fuel and high-level waste for 100 years followed by geologic disposal. For only on-site storage for 100 years without disposal, costs would range from \$10 billion to \$26 billion for 70,000 metric tons of waste and from \$13 billion to \$34 billion for 153,000 metric tons of waste. On-site storage costs would increase significantly if the waste were stored for longer periods—storing 153,000 metric tons on site for 500 years would cost from \$34 billion to \$225 billion—because it would have to be repackaged every 100 years for safety. The on-site storage model scenarios include the costs of on-site operations required to package the waste into dry canister storage, build additional dry storage at the reactor sites, prepare the waste for transportation, and operate and maintain the on-site storage facilities. Most of the costs for the first 100 years would result from the initial loading of materials into dry storage systems. (See app. IV for information on our modeling methodology, assumptions, and results.)

**Table 5: Estimated Cost Range for Each On-site Storage Scenario**

| Dollars in billions   |  |                                   |
|---|--|-----------------------------------|
| On-site storage scenario  | Period covered <sup>a</sup>            | 2009 present value estimate range |
| Storage of 70,000 metric tons   | 2009 to 2108 (100 years)               | \$10 to \$26                      |
| Storage of 153,000 metric tons  | 2009 to 2108 (100 years)               | \$13 to \$34                      |
| Storage of 153,000 metric tons, with disposal in a permanent repository after 100 years | 2009 to 2240 (232 years <sup>b</sup> ) | \$20 to \$97                      |
| Storage of 153,000 metric tons with repackaging every 100 years                         | 2009 to 2508 (500 years)               | \$34 to \$225                     |

Source: GAO analysis of data provided by nuclear waste management experts and DOE.

<sup>a</sup>See appendix IV for an explanation of the periods covered by the scenarios.

<sup>b</sup>This period was chosen to capture costs of the hypothetical geologic repository through closure.

Actual on-site storage costs may be more or less than these cost ranges if a different on-site storage scenario is implemented. For example, to keep it distinct from the centralized storage models, our on-site storage models

---

assume that there would be no transportation or consolidation of waste between the reactor sites. However, several experts noted that in an actual on-site storage scenario, reactor operators would likely consolidate their waste to make operations more efficient and reduce costs. Also, as with the centralized storage alternative, costs for the on-site storage scenario that includes geologic disposal could differ for a repository site other than Yucca Mountain or for additional waste management technologies.

Finally, our models did not include certain costs that were either location-specific or could not be predicted sufficiently to be quantified for our purposes, which would make the actual costs of on-site storage higher than our cost ranges. For example, the taxes and fees associated with on-site storage could vary significantly by state and over time. Also, repackaging operations in our 500-year on-site storage scenario would generate low-level waste that would require disposal. However, the amount of waste generated and the associated disposal costs could vary depending on the techniques used for repackaging. Finally, the total amount of the government's liability for failure to begin taking spent nuclear fuel for disposal in 1998 will depend on the outcome of pending and future litigation.

Like the centralized storage alternative, the funding source for the on-site storage alternative is uncertain. Currently, the reactor operators have been paying for the cost to store the waste, but have filed lawsuits to be compensated for storage costs of waste that the federal government was required to take title to under standard contracts. Payments resulting from these lawsuits have come from the Department of the Treasury's judgment fund, which is funded by the taxpayer, because a court determined that the Nuclear Waste Fund could not be used to compensate electric power companies for their storage costs. Without legislative or contractual changes—such as allowing the Nuclear Waste Fund to be used for on-site storage—taxpayers would likely bear the ultimate costs for on-site storage.

---

## Concluding Observations

Developing a long-term national strategy for safely and securely managing the nation's high-level nuclear waste is a complex undertaking that must balance health, social, environmental, security, and financial factors. In addition, virtually any strategy considered will face many political, legal, and regulatory challenges in its implementation. Any strategy selected will need to have geologic disposal as a final disposition pathway. In the case of the Yucca Mountain repository, these challenges have left the nation with nearly three decades of experience. In moving forward, whether the

---

nation commits to the same or a different waste management strategy, federal agencies, industry, and policy makers at all levels of government can benefit from the lessons of Yucca Mountain. In particular, stakeholders can better understand the need for a sustainable national focus and community commitment. Federal agencies, industry, and policymakers may also want to consider a strategy of complementary and parallel interim and long-term disposal options—similar to those being pursued by some other nations—which might provide the federal government with maximum flexibility, since it would allow time to work with local communities and to pursue research and development efforts in key areas, such as reprocessing.

---

## Agency Comments

We provided DOE and NRC with a draft of this report for their review and comment. In their written comments, DOE and NRC generally agreed with the report. (See apps. V and VI.) In addition, both DOE and NRC provided comments to improve the draft report's technical accuracy, which we have incorporated as appropriate.

We also discussed the draft report with representatives of the Nuclear Waste Technical Review Board, the Nuclear Energy Institute, and the State of Nevada Agency for Nuclear Projects. These representatives provided comments to clarify information in the draft report, which we have incorporated as appropriate.

---

As agreed with your offices, unless you publicly announce the contents of this report earlier, we plan no further distribution until 30 days from the report date. At that time, we will send copies of this report to other appropriate congressional committees, the Secretary of Energy, the Chairman of NRC, the Director of the Office of Management and Budget, and other interested parties. The report also will be available at no charge on the GAO Web site at <http://www.gao.gov>.

---

If you or your staffs have any questions about this report, please contact me at (202) 512-3841 or [gaffiganm@gao.gov](mailto:gaffiganm@gao.gov). Contact points for our Offices of Congressional Relations and Public Affairs can be found on the last page of this report. GAO staff who made major contributions to this report are listed in appendix VII.

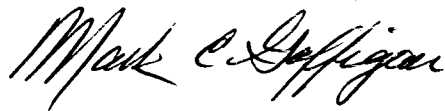
A handwritten signature in black ink that reads "Mark E. Gaffigan". The signature is written in a cursive, flowing style.

Mark E. Gaffigan  
Director, Natural Resources  
and Environment

---

# Appendix I: Scope and Methodology

---

For this report we examined (1) the key attributes, challenges, and costs of the Yucca Mountain repository; (2) alternative nuclear waste management approaches; (3) the key attributes, challenges, and costs of storing the nuclear waste at two centralized sites; and (4) the key attributes, challenges, and costs of continuing to store the nuclear waste at its current locations.

---

## Developing Information on Key Attributes, Challenges, and Costs of Yucca Mountain

To provide information on the key attributes and challenges of the Yucca Mountain repository, we reviewed documents and interviewed officials from the Department of Energy's (DOE) Office of Civilian Radioactive Waste Management and Office of Environmental Management; the Nuclear Regulatory Commission's (NRC) Division of Spent Fuel Storage and Transportation and Division of High Level Waste Repository Safety, both within the Office of Nuclear Material Safety and Safeguards; and the Department of Justice's Civil Division. We also reviewed documents and interviewed representatives from the National Academy of Sciences, the Nuclear Waste Technical Review Board, and other concerned groups. Once we developed our preliminary analysis of Yucca Mountain's key attributes and challenges, we solicited input from nuclear waste management experts. (See app. II for our methodology for soliciting comments from nuclear waste management experts and app. III for a list of these experts.)

To analyze the costs for the Yucca Mountain repository through to closure, we started with the cost information in DOE's Yucca Mountain Total System Lifecycle Cost report, which used 122,100 metric tons of nuclear waste in its analysis.<sup>1</sup> We asked DOE officials to provide a breakdown of the component costs on a per-metric-ton basis that DOE used in the Total System Lifecycle Cost report. We used this information to calculate the costs of a repository at Yucca Mountain for 70,000 metric tons and 153,000 metric tons, changing certain component costs based on the ratio between 70,000 and 122,100 or 153,000 and 122,100. For example, we modified the cost of constructing the tunnels for emplacing the waste for the 70,000-metric-ton scenario by 0.57, the ratio of 70,000 metric tons to 122,100 metric tons. We applied this approach to component costs that would be

---

<sup>1</sup>DOE, *Analysis of the Total System Lifecycle Cost of the Civilian Radioactive Waste Management Program, Fiscal Year 2007*, DOE/RW-0591 (Washington, D.C., July 2008). The 122,100 metric tons of nuclear waste included the spent nuclear fuel expected to be generated from all commercial nuclear reactors that had received NRC license extensions through January 2007.



impacted by the ratio difference, particularly for transporting and emplacing the waste and installing drip shields. We also incorporated DOE's cost estimates for potential delays to licensing the Yucca Mountain repository into our analysis and made modifications to the analysis based on comments by cognizant DOE officials. Finally, we discounted DOE's costs, which were in 2008 constant dollars, to 2009 present value using the methodology described in appendix IV.

---

### Examining and Identifying Nuclear Waste Management Alternatives

To examine and identify alternatives, we started with a series of interviews among federal and state officials and industry representatives. We also gathered and reviewed numerous studies and reports on managing nuclear waste— along with interviewing the authors of many of these studies— from federal agencies, the National Academy of Sciences, the Nuclear Waste Technical Review Board, the Massachusetts Institute of Technology, the American Physical Society, Harvard University, the Boston Consulting Group, and the Electric Power Research Institute. To better understand how commercial spent nuclear fuel is stored, we visited the Dresden Nuclear Power Plant in Illinois and the Hope Creek Nuclear Power Plant in New Jersey, which both store spent nuclear fuel in pools and in dry cask storage. We also visited DOE's Savannah River Site in South Carolina and Fort St. Vrain site in Colorado to observe how DOE-managed spent nuclear fuel and high-level waste are processed and stored.

As we began to identify potential alternatives to analyze, we shared our initial approach and methodology with nuclear waste management experts—including members of the National Academy of Sciences and the Nuclear Waste Technical Review Board to obtain their feedback—and revised our approach accordingly. Many of these experts advised us to develop generic, hypothetical alternatives with clearly defined assumptions about technology and environmental conditions. Industry representatives and other experts advised us that trying to account for the thousands of variables relating to geography, the environment, regional regulatory differences, or differences in business models would result in infeasible and unmanageable models. They also advised us against trying to predict changes in the future for technologies or environmental conditions because they would purely conjectural and fall beyond the scope of this analysis.

Based on this information, we identified two generic, hypothetical alternatives to use as the basis of our analysis: centralized storage and on-site storage. Within each of these alternatives, we identified different scenarios that examined the costs associated with the management of

70,000 metric tons and 153,000 metric tons of nuclear waste and whether or not the waste is shipped to a repository for disposal after 100 years.

Once we identified the alternatives, we again consulted with experts to establish assumptions regarding commercial spent nuclear fuel management and its associated components to define the scope and specific processes that would be included in each alternative. To identify a more complete, qualified list of nuclear waste management experts with relevant experience who could provide and critique this information, we used a technique known as snowballing. We started with experts in the field who were known to us, primarily from DOE, NRC, National Council of State Legislators, the State of Nevada Agency for Nuclear Projects, the Nuclear Energy Institute, and the National Association of Regulatory Utility Commissioners and asked them to refer us to other experts, focusing on U.S.-based experts. We then contacted these individuals and asked for additional referrals. We continued this iterative process until additional interviews did not lead us to any new names or we determined that the qualified experts in a given technical area had been exhausted.

We conducted an initial interview with each of these experts by asking them questions about the nature and extent of their expertise and their views on the Yucca Mountain repository. Specifically, we asked each expert:

- What is the nature of your expertise? How many years have you been doing work in this area? Does your expertise allow you to comment on planning assumptions and costs of waste management related to storage, disposal, or transport?
- If you were to classify yourself in relation to the Yucca Mountain repository, would you classify yourself as a proponent, an opponent, an independent, an undecided or uncommitted, or some combination of these?

We then narrowed our list down to those individuals who identified themselves or whom others identified as having current, nationally recognized expertise in areas of nuclear waste management that were relevant to our analysis. For balance, we ensured that we included experts who reflected (1) key technical areas of waste management; (2) a range of industry, government, academia, and concerned groups; and (3) a variety of viewpoints on the Yucca Mountain repository. (See app. III for 147 experts we contacted.)

Once we developed our list of experts, we classified them into three groups:

- Those whose expertise would allow them to provide us with specific information and advice on the processes that should be included in each alternative and the best estimates of expected cost ranges for the components of each alternative, such as a typical or reasonable price for a dry cask storage.
- Those who could weigh in on these estimates, as well as give us insight and comments on assumptions that we planned to use to define our alternatives.
- Those whose expertise was not in areas of component costs, but who could nonetheless give us valuable information on other assumptions, such as transportation logistics.

To define our alternatives and develop the assumptions and cost components we needed for our analysis, we started with the experts from the first group who had the most direct and reliable knowledge of the processes and costs associated with the alternatives we identified. This group consisted of seven experts and included federal government officials and representatives from industry. We worked closely with these experts to identify the key assumptions that would establish the scope of our alternatives, the more specific assumptions to identify the processes associated with each alternative, the components of these processes that we could quantify in terms of cost, and the level of uncertainty associated with each component cost. For example, two of the experts in this first group told us that for the on-site alternative, commercial reactor sites that did not already have independent spent nuclear fuel storage installations would have to build them during the next 10 years and that the cost for licensing, design, and construction of each installation would range from \$24 million to \$36 million. Once we had gathered our initial assumptions and cost components, we used a data collection instrument to solicit comments on them from all of our experts. We then used the experts' comments to refine our assumptions and component costs. (See app. II for our methodology for consulting with this larger group of nuclear waste management experts.)

DOE officials provided assumptions and cost data for managing DOE spent nuclear fuel and high-level waste, which we incorporated into our analysis of the centralized storage and on-site storage alternatives. These assumptions and cost information covered management of spent nuclear

---

fuel and high-level waste at DOE's Idaho National Laboratory, Hanford Reservation, Savannah River Site, and West Valley site.

---

**Developing Information on Key Attributes, Challenges, and Costs of the Centralized Storage and On-Site Storage Alternatives**

To gather information on the key attributes and challenges of our alternatives, we interviewed agency officials and nuclear waste management experts from industry, academic institutions, and concerned groups. We also reviewed the reports and studies and visited the locations that were mentioned in the previous section. To ensure that the attributes and challenges we developed were accurate, comprehensive, and balanced, we asked our snowballed list of experts to provide their comments on our work, using the data collection instrument that is described in appendix II. We used the comments that we received to expand the attributes or challenges on our list or, where necessary, to modify our characterization of individual attributes or challenges.

To generate cost ranges for the centralized storage and on-site storage alternatives, we developed four large-scale cost models that analyzed the costs for each alternative of storing 70,000 metric tons and 153,000 metric tons of nuclear waste for 100 years followed by disposal in a geologic repository. (See app. IV.) We also generated cost ranges for each alternative of storing the waste for 100 years without including the cost of subsequent disposal in a geologic repository for storing 153,000 metric tons of waste on site for 500 years. For each model, which rely upon data and assumptions provided by nuclear waste management experts, the cost range was based on the annual volume of commercial spent nuclear fuel that became ready to be packaged and stored in each year. In general, each model started in 2009 by annually tracking costs of initial packaging and related costs for the first 100 years and for every 100 years thereafter if the waste was to remain on site and be repackaged. Since our models analyzed only the costs associated with storing commercial nuclear waste management, we augmented them with DOE's cost data for (1) managing its spent nuclear fuel and high-level waste and (2) constructing and operating a permanent repository. Specifically, we used DOE's estimated costs for the Yucca Mountain repository to represent cost for a hypothetical permanent repository.<sup>2</sup>

---

<sup>2</sup>We excluded historical costs for the Yucca Mountain repository because these costs represent challenges unique to Yucca Mountain and may not be applicable to a future repository. However, the bulk of future cost for construction, operation, and closure may be representative of a new repository.

---

We conducted this performance audit from April 2008 to October 2009 in accordance with generally accepted government auditing standards. These standards require that we plan and perform the audit to obtain sufficient, appropriate evidence to provide a reasonable basis for our findings and conclusions based on our audit objectives. We believe that the evidence obtained provides a reasonable basis for our findings and conclusions based on our audit objectives.

---

# Appendix II: Our Methodology for Obtaining Comments from Nuclear Waste Management Experts

---

As discussed in appendix I, we gathered the assumptions and associated component costs used to define our nuclear waste management alternatives by consulting with experts in an iterative process of identifying initial assumptions and component costs and revising them based on expert comments. This appendix (1) describes the data collection instrument we used to obtain comments on the initial assumptions and component costs, (2) describes how we analyzed the comments and revised our assumptions, and (3) provides a list of the assumptions and cost data that we derived through this process and used in our cost models.

To obtain comments from a broad group of nuclear waste management experts, we compiled the initial assumptions and component costs that we gathered from a small group of experts into a data collection instrument that included

- a description of the Yucca Mountain repository and our proposed nuclear waste management alternatives—on-site storage and centralized storage—and attributes and challenges associated with them;
- our initial assumptions that would identify and define the processes, time frames, and major components used to bound our hypothetical centralized and on-site storage alternatives;
- the major component costs of each alternative, including definitions and initial cost data; and
- components associated with each alternative with a high degree of uncertainty that we did not attempt to quantify in terms of costs.

The data collection instrument asked the experts to answer specific questions about each piece of information that we provided (see table 6).

**Table 6: Our Data Collection Instrument for Nuclear Waste Management Experts**

| <b>Section of the data collection instrument</b>                  | <b>Questions asked of the experts</b>  |
|---|--|
| Description of each alternative and its attributes and challenges | What additional issues do you suggest we consider, or is there one listed that you would modify?   |
| List of initial assumptions for each alternative                  | To what extent do you think this assumption is reasonable or unreasonable? <sup>a</sup><br>If this assumption does not seem reasonable, please describe. <sup>a</sup><br>Are there additional assumptions defining our scenario not mentioned above that you would recommend GAO consider? Please describe.  |
| List of component costs and initial cost data                     | Is this estimate reasonable or unreasonable? <sup>a</sup><br>If this estimate is not reasonable, please describe why (estimate too high, estimate too low, range too broad, range too narrow) and, if possible, provide specific alternative cost estimates. <sup>a</sup><br>Please tell us anything about this cost item that might make it difficult (or not difficult) to estimate accurately? <sup>a</sup><br>Are there additional cost categories not mentioned above that you would recommend GAO consider? Please provide a generic cost estimate or potential source of such an estimate, if possible. |
| List of uncertain components                                      | In your opinion, do you think any of these items can be quantified? If so, please provide suggestions for how to quantify them, along with supporting data, if available.  |

Source: GAO.

<sup>a</sup>This question was asked after each assumption or component.

We pretested our instrument with several individual experts to ensure that our questions were clear and would provide us with the information that we needed, and then refined the instrument accordingly. Next, we sent the instrument to 114 experts who were identified through our snowballing methodology (see apps. I and III). Each expert received the sections of our data collection instrument that included the attributes and challenges of the alternatives and the initial assumptions, but only those experts with the type and level of expertise to comment on costs received the cost component sections.

We received 67 sets of comments from independent experts and experts representing industry, federal government, state governments, and other concerned groups.<sup>1</sup> These experts also represented a range of viewpoints on the Yucca Mountain repository. Each of their responses was compiled

<sup>1</sup>The 67 sets of comments do not reflect the total number of experts who responded because some groups of affiliated experts compiled their comments into a single response. For example, DOE's Office of Civilian Radioactive Waste Management provided a consolidated set of comments for its nine experts.

into a database organized by each individual assumption or cost element for the on-site storage and centralized interim storage alternatives.

To arrive at the final assumptions and cost component data for our models, we qualitatively analyzed the experts' comments. The comments we received on the assumptions differed in nature from those we received on the component costs, so our analysis and disposition of comments differed slightly. For the assumptions, we took the comments on each assumption that were made when an expert did not believe it was entirely reasonable and grouped comments that were similar. We determined the relevance of a comment to our assumption based on whether the comment provided a basis upon which we could modify the assumption or was within the scope or capability of our models. For example, we received several comments about how an assumption may be affected by nuclear waste from new reactors, including potential liabilities if the Department of Energy (DOE) does not take custody of that waste, but in the key assumptions defining our alternatives, we explicitly excluded new reactors because we could not predict how many new reactors would be built, when they would operate, and the amount of waste that they would generate. For those comments that were relevant, we weighed the expertise of those making the comments and determined whether the balance of the comments warranted a modification to our preliminary assumption. In some instances, we conducted followup interviews with selected experts to clarify issues that the broad group of experts raised.

For the component costs, we organized the comments on a particular component based on whether an expert thought the cost and uncertainty range was reasonable, too high, too low, the range was too broad, or the range was too narrow. We developed a ranking system to identify which experts had the greatest degree of direct experience or knowledge with the cost and weighed their comments accordingly to determine whether our preliminary cost should be modified. Also, we took into account the incidence of expert agreement or disagreement when deciding how much uncertainty to apply to a particular cost.

Through this analysis, we determined that the preponderance of our preliminary assumptions and cost data were reasonable for use in our models either because the experts generally agreed it was reasonable, or the experts who thought it was reasonable had a greater degree of relevant expertise or knowledge than those who commented otherwise. However, some of the experts' responses indicated that a modification to our model was needed. Table 7 presents a summary of the modifications we made to



**Appendix II: Our Methodology for Obtaining Comments from Nuclear Waste Management Experts**

our model assumptions and cost data based on the expert comments received.

**Table 7: Initial Assumptions and Component Cost Estimates for Our Centralized Storage and On-site Storage Alternatives and Modifications Made Based on Experts' Responses to Our Data Collection Instrument**

| <b>Centralized storage</b>            |  |  |
|---------------------------------------|--|--|
| <b>Key aspect of the alternative</b>  | <b>Initial key assumption</b>  | <b>Modification based on expert comments</b>   |
| Number of sites                       | Two sites located in different geographic regions of the country.  | None   |
| Reactor operations                    | Current reactors will receive, if they have not already, a 20-year license extension and will operate until the end of their licensed life.  | None   |
|                                       | When reactors cease operations, they will be decommissioned and only spent nuclear fuel dry storage will remain on site.   | None   |
| Transportation                        | Transportation will be the similar to what is assumed for the Yucca Mountain repository—via rail, using dedicated trains.  | None   |
| Repackaging                           | Waste will not be repackaged at the centralized facilities. <sup>a</sup>   | None   |
| Final disposition                     | Waste will be stored at the centralized sites until 100 years from now and then be disposed of in a geologic repository. <sup>b</sup>  | None   |
| <b>Process</b>                        | <b>Initial process assumption</b>  | <b>Modification based on expert comments</b>   |
| Waste packaged into dry storage casks | Reactor operators will only move the amount of waste from pools into dry storage that is necessary to preserve full-core offload capability—the capacity in their spent nuclear fuel pools to store all of the fuel in the reactor core. | None   |
|                                       | The overall amount of fuel moved from the pools to dry storage will be equal to estimated annual rates at which fuel is discharged from the reactors.  | None   |
|                                       | Dual-purpose canister systems will be used until Transportation, Aging and Disposal systems become widely available.   | Only dual-purpose systems will be used.  |
|                                       | Transportation, Aging and Disposal systems will have a capacity of 8.5 metric tons plus or minus 5 percent.  | None (although this assumption became obsolete when we no longer assumed transportation, aging, and disposal systems would be used). |

**Appendix II: Our Methodology for Obtaining  
Comments from Nuclear Waste Management  
Experts**

| <b>Centralized storage</b>  |  |  |
|---|--|--|
| Reactor site dry storage  | All reactor sites without dry storage facilities will construct them at the time they lose full-core offload capability—the capacity in their spent nuclear fuel pools to store all of the fuel in the reactor core. | None   |
|   | Dry storage operations and maintenance costs vary by nature of the site, such as operating versus decommissioned.  | None   |
|   | On average, 1.5 decommissioned reactor sites will be cleared of their waste each year.   | None   |
| Transportation to centralized storage   | Once running at full capacity, transportation rates will be approximately 3,000 metric tons per year (what is assumed for Yucca Mountain).   | None   |
|   | Waste from decommissioned sites and GE Morris will be transported before waste from operating sites. This waste would not be converted to dry storage prior to transportation.                                       | None   |
|   | 133 transportation casks will be required (what is assumed for Yucca Mountain) and will be acquired over a 7-year period.  | None   |
|   | No new rail construction will be required.   | None   |
|   | Transportation system infrastructure, system support, and operations will be analogous to what DOE assumes for Yucca Mountain.   | None   |
| Centralized storage   | The two centralized facilities will begin accepting waste in 2028.   | None   |
|   | The sites will be built at existing federal facilities and be owned and operated by DOE.   | None   |
| Geologic disposal   | Waste will not be repackaged before being disposed of in a permanent repository.   | None   |
|   | Any spent nuclear fuel not originally packaged into a Transportation, Aging and Disposal canister will be repackaged at the geologic repository.   | This assumption became obsolete when we no longer assumed transportation, aging, and disposal canisters would be used. |
| <b>Process component</b>  | <b>Initial component cost estimate</b>   | <b>Modification based on expert comments</b>   |
| Dry cask storage systems:   |  |  |
| <ul style="list-style-type: none"> <li>transportation, aging, and disposal</li> <li>dual-purpose</li> </ul>   | <ul style="list-style-type: none"> <li>\$1.1 million plus or minus 10 percent</li> <li>\$900,000 plus or minus 5 percent</li> </ul>  | <ul style="list-style-type: none"> <li>Obsolete</li> <li>\$900,000 plus or minus 25 percent</li> </ul>                 |
| Loading operations:   |  |  |
| <ul style="list-style-type: none"> <li>cost per cask to load fuel into dry storage canisters</li> <li>loading campaign consisting, on average, of five casks (including set-up, clean up, training, and labor)</li> </ul> | <ul style="list-style-type: none"> <li>\$150,000 plus or minus 5 percent</li> <li>\$750,000 plus or minus 5 percent</li> </ul>   | <ul style="list-style-type: none"> <li>\$275,000 plus or minus 45 percent</li> <li>None</li> </ul>                     |

**Appendix II: Our Methodology for Obtaining  
Comments from Nuclear Waste Management  
Experts**

| <b>Centralized storage</b>   |   |  |
|--|---|--|
| Design, licensing, and construction of dry storage installations at reactor sites  | \$30 million plus or minus 20 percent   | \$30 million plus or minus 40 percent  |
| Annual operations and maintenance:   |   |  |
| <ul style="list-style-type: none"> <li>• operating reactor site dry storage</li> <li>• decommissioned reactor site dry storage</li> <li>• decommissioned reactor site wet storage</li> </ul> | <ul style="list-style-type: none"> <li>• \$100,000 plus or minus 20 percent</li> <li>• \$3 million plus or minus 20 percent</li> <li>• \$10 million plus or minus 20 percent</li> </ul> | <ul style="list-style-type: none"> <li>• \$100,000 plus or minus 50 percent</li> <li>• \$4.5 million plus or minus 40 percent</li> <li>• None</li> </ul> |
| Transportation casks   | \$4.5 million plus or minus 10 percent  | None   |
| Loading for transportation cost per canister   | \$250,000 plus or minus 5 percent   | \$150,000 plus or minus 40 percent   |
| Transportation infrastructure:   |   |  |
| <ul style="list-style-type: none"> <li>• rolling stock and facilities</li> <li>• transportation system support</li> </ul>  | <ul style="list-style-type: none"> <li>• \$400 million plus or minus 10 percent</li> <li>• \$2.5 billion plus or minus 10 percent</li> </ul>  | <ul style="list-style-type: none"> <li>• None</li> <li>• None</li> </ul>   |
| Transportation operations per-metric-ton   | \$26,000 plus or minus 10 percent   | None   |
| Centralized facility licensing and construction:   |   |  |
| <ul style="list-style-type: none"> <li>• 70,000 metric ton facility</li> <li>• 153,000 metric ton facility</li> </ul>  | <ul style="list-style-type: none"> <li>• \$168 million plus or minus 10 percent</li> <li>• \$232 million plus or minus 10 percent</li> </ul>  | <ul style="list-style-type: none"> <li>• \$218 million plus or minus 20 percent</li> <li>• \$302 million plus or minus 20 percent</li> </ul>             |
| Centralized facility annual operations and maintenance   | \$8.8 million plus or minus 10 percent  | None   |
| <b>On-site storage</b>   |   |  |
| <b>Key aspect of the alternative</b>   | <b>Initial key assumption</b>   | <b>Modification based on expert comments</b>   |
| Number of commercial sites   | Commercial spent nuclear fuel spent nuclear fuel will be stored at 75 reactor sites.  | None   |
| Number of DOE sites  | DOE high-level waste and spent nuclear fuel will remain at five current sites.  | None   |
| Reactor operations   | Current reactors will receive, if they have not already, a 20-year license extension and will operate until the end of their licensed life.   | None   |
|  | When reactors cease operations, they will be decommissioned and only spent nuclear fuel dry storage will remain on site.  | None   |
| Transportation   | There will be no transportation of waste between sites.   | None   |
| Repackaging  | Dry cask storage systems would require repackaging every 100 years.   | None   |

**Appendix II: Our Methodology for Obtaining  
Comments from Nuclear Waste Management  
Experts**

| <b>On-site storage</b>  |   |  |
|---|---|--|
| <b>Process</b>  | <b>Initial process assumption</b>   | <b>Modification based on expert comments</b>   |
| Waste packaged into dry storage casks   | Reactor operators will use generic dual-purpose canisters for dry storage with a capacity of 13 metric tons plus or minus 5 percent.  | Range increased to plus or minus 15 percent.   |
|   | Reactor operators will only move the amount of waste from pools into dry storage that is necessary to preserve full-core offload capability.  | None   |
|   | The overall amount of fuel moved from the pools to dry storage will be equal to estimated annual rates at which fuel is discharged from the reactors.                                   | None   |
| Reactor site dry storage  | All reactor sites without dry storage facilities will construct them at the time they lose full-core offload capability.  | None   |
|   | Dry storage operations and maintenance costs vary by nature of the site, such as operating versus decommissioned.   | None   |
| Repackaging   | Wet transfer facilities will need to be built at each site for every packaging interval (i.e. every 100 years).   | We will assume a generic transfer system that could be either wet or dry.  |
|   | All sites will need to replace their dry storage pad and infrastructure every 100 years when they repackage.  | None   |
| <b>Process component</b>  | <b>Initial component cost estimate</b>  | <b>Modification based on expert comments</b>   |
| Dry cask storage system   | \$900,000 plus or minus 5 percent   | \$900,000 plus or minus 25 percent   |
| Loading operations: <ul style="list-style-type: none"> <li>• cost per cask to load fuel into dry storage canisters</li> <li>• loading campaign consisting, on average, of five casks (including set-up, clean up, training, and labor)</li> </ul> | <ul style="list-style-type: none"> <li>• \$150,000 plus or minus 5 percent</li> <li>• \$750,000 plus or minus 5 percent</li> </ul>  | <ul style="list-style-type: none"> <li>• \$275,000 plus or minus 45 percent</li> <li>• None</li> </ul>   |
| Design, licensing, and construction of dry storage installations at reactor sites   | \$30 million plus or minus 20 percent   | \$30 million plus or minus 40 percent  |
| Annual operations and maintenance: <ul style="list-style-type: none"> <li>• operating reactor site dry storage</li> <li>• decommissioned reactor site dry storage</li> <li>• decommissioned reactor site wet storage</li> </ul>                   | <ul style="list-style-type: none"> <li>• \$100,000 plus or minus 20 percent</li> <li>• \$3 million plus or minus 20 percent</li> <li>• \$10 million plus or minus 20 percent</li> </ul> | <ul style="list-style-type: none"> <li>• \$200,000 plus or minus 50 percent</li> <li>• \$4.5 million plus or minus 40 percent</li> <li>• None</li> </ul> |
| Construction of a transfer facility for repackaging   | \$300 million plus or minus 50 percent (for a wet transfer facility)  | \$300 million plus or minus 50 percent (for either a wet or a dry transfer facility)   |

**Appendix II: Our Methodology for Obtaining  
Comments from Nuclear Waste Management  
Experts**

**On-site Storage**

Repackaging operations:

- |   |  |  |
|---|--|--|
| <ul style="list-style-type: none"> <li>• repackaging costs per cask</li> <li>• repackaging campaign consisting, on average, of 5 casks (including set-up, clean up, training, and labor)</li> </ul> | <ul style="list-style-type: none"> <li>• \$1.2 million plus or minus 10 percent</li> <li>• \$750,000 plus or minus 10 percent</li> </ul> | <ul style="list-style-type: none"> <li>• \$1.6 million plus or minus 10 percent</li> <li>• None</li> </ul> |
|---|--|--|

|                         |                                       |                                       |
|-------------------------|---------------------------------------|---------------------------------------|
| Storage pad replacement | \$30 million plus or minus 20 percent | \$30 million plus or minus 40 percent |
|-------------------------|---------------------------------------|---------------------------------------|

Source: GAO analysis based on expert-provided data.

Note: Unless specifically noted, all assumptions and costs apply specifically to commercial nuclear power sites. We used information provided by DOE for the assumptions and costs related to DOE-managed spent nuclear fuel and high-level waste.

<sup>a</sup>We did not explicitly solicit comment on this assumption in the data collection instrument for the centralized storage alternative because we solicited comments on the repackaging requirements in the on-site alternative.

<sup>b</sup>This assumption applies only to the version of our centralized storage alternative that includes final disposal.

# Appendix III: Nuclear Waste Management Experts We Interviewed

|    | <b>Name</b>         | <b>Affiliation</b>   |
|----|---------------------|--|
| 1  | Mark D. Abkowitz    | U.S. Nuclear Waste Technical Review Board (member)   |
| 2  | John Ahearne        | Sigma Xi   |
| 3  | Joonhong Ahn        | National Academy of Sciences/Nuclear and Radiation Studies Board   |
| 4  | David Applegate     | U.S. Geological Survey   |
| 5  | Wm. Howard Arnold   | U.S. Nuclear Waste Technical Review Board (member)   |
| 6  | Tom Baillieul       | The Chamberlain Group  |
| 7  | James David Ballard | California State University, Northridge  |
| 8  | William D. Barnard  | U.S. Nuclear Waste Technical Review Board (retired) (staff)  |
| 9  | Lake Barrett        | DOE/Office of Civilian Radioactive Waste Management (retired)  |
| 10 | Barbara Beller      | DOE/Office of Environmental Management   |
| 11 | David W. Bland      | TriVis Incorporated  |
| 12 | Ted Borst           | CH2M-WG Idaho, LLC   |
| 13 | David C. Boyd       | Minnesota Public Utilities Commission  |
| 14 | Michele Boyd        | Physicians for Social Responsibility   |
| 15 | William Boyle       | DOE/Office of Civilian Radioactive Waste Management  |
| 16 | E. William Brach    | Nuclear Regulatory Commission (NRC)/Division of Spent Fuel Storage and Transportation  |
| 17 | Bruce Breslow       | State of Nevada Agency for Nuclear Projects  |
| 18 | Philip Brochman     | NRC/Office of Nuclear Security and Incident Response   |
| 19 | Tom Brookmire       | Dominion Resources, Inc.   |
| 20 | Robert J. Budnitz   | Lawrence Berkeley National Laboratory  |
| 21 | Susan Burke         | Idaho Department of Environmental Quality  |
| 22 | Barbara Byron       | Western Interstate Energy Board  |
| 23 | Robert Capstick     | The Yankee Nuclear Power Companies   |
| 24 | Thure E. Cerling    | U.S. Nuclear Waste Technical Review Board (member)   |
| 25 | Margaret Chu        | M.S. Chu & Associates  |
| 26 | Tom Clements        | Friends of the Earth   |
| 27 | Jean Cline          | University of Nevada Las Vegas   |
| 28 | Thomas Cochran      | Natural Resources Defense Council  |
| 29 | Marshall Cohen      | Nuclear Energy Institute   |
| 30 | Kevin Crowley       | Nuclear and Radiation Studies Board, National Research Council of the National Academies   |
| 31 | Jeanne Davidson     | U.S. Department of Justice/Civil Division  |
| 32 | Bradley Davis       | DOE/Office of Nuclear Energy   |
| 33 | Jack Davis          | NRC/Division of High Level Waste Repository Safety   |
| 34 | Jay C. Davis        | Lawrence Livermore National Laboratory (retired)<br>Nuclear and Radiation Studies Board, National Research Council of the National Academies |

**Appendix III: Nuclear Waste Management  
Experts We Interviewed**

|    | <b>Name</b>          | <b>Affiliation</b>   |
|----|----------------------|--|
| 35 | Scott DeClue         | DOE/Office of Environmental Management   |
| 36 | Edgardo DeLeon       | DOE/Office of Environmental Management   |
| 37 | Fred Dilger          | Black Mountain Research  |
| 38 | David J. Duquette    | U.S. Nuclear Waste Technical Review Board (member)   |
| 39 | Doug Easterling      | Wake Forest University   |
| 40 | Steven Edwards       | Progress Energy  |
| 41 | Randy Elwood         | CH2M-WG Idaho, LLC   |
| 42 | Rod Ewing            | University of Michigan   |
| 43 | Steve Fetter         | University of Maryland   |
| 44 | James Flynn          | Pacific World History Institute  |
| 45 | Charles Forsberg     | Massachusetts Institute of Technology  |
| 46 | Derrick Freeman      | Nuclear Energy Institute   |
| 47 | Steve Frishman       | State of Nevada Nuclear Waste Project Office   |
| 48 | Robert Fronczak      | Association of American Railroads  |
| 49 | B. John Garrick      | U.S. Nuclear Waste Technical Review Board (chairman)   |
| 50 | Ron Gecan            | U.S. Congressional Budget Office   |
| 51 | Lynn Gelhar          | Massachusetts Institute of Technology  |
| 52 | Christine Gelles     | DOE/Office of Environmental Management   |
| 53 | Robert Gisch         | Department of Defense/Department of the Navy   |
| 54 | Aubrey Godwin        | Arizona Radiation Regulatory Agency  |
| 55 | Charles R. Goergen   | Washington Savannah River Company <sup>a</sup>   |
| 56 | Stephen Goldberg     | Argonne National Laboratory  |
| 57 | Steven Grant         | Bechtel SAIC Company, LLC <sup>b</sup>   |
| 58 | Paul Gunter          | Beyond Nuclear   |
| 59 | Brian Gustems        | PSEG Nuclear, LLC  |
| 60 | Brian Gutherman      | ACI Nuclear Energy Solutions   |
| 61 | Roger L. Hagengruber | University of New Mexico<br>Nuclear and Radiation Studies Board, National Research Council of the National Academies |
| 62 | R. Scott Hajner      | Bechtel SAIC Company, LLC <sup>b</sup>   |
| 63 | Robert Halstead      | Transportation Advisor, State of Nevada Agency for Nuclear Projects  |
| 64 | Paul Harrington      | DOE/Office of Civilian Radioactive Waste Management  |
| 65 | Ronald Helms         | Bechtel SAIC Company, LLC <sup>b</sup>   |
| 66 | Damon Hindle         | Bechtel SAIC Company, LLC <sup>b</sup>   |
| 67 | James Hollrith       | DOE/Office of Civilian Radioactive Waste Management  |
| 68 | Greg Holden          | Department of Defense/Department of the Navy   |
| 69 | Mark Holt            | U.S. Congressional Research Service  |
| 70 | George M. Hornberger | U.S. Nuclear Waste Technical Review Board (member)   |

**Appendix III: Nuclear Waste Management  
Experts We Interviewed**

|     | <b>Name</b>          | <b>Affiliation</b>  |
|-----|----------------------|---|
| 71  | William Hurt         | Idaho National Laboratory   |
| 72  | Thomas H. Isaacs     | Stanford University<br>Lawrence Livermore National Laboratory<br>Nuclear and Radiation Studies Board, National Research Council of the National Academies |
| 73  | Lisa R. Janairo      | Council of State Governments, Midwestern Office   |
| 74  | Andrew C. Kadak      | U.S. Nuclear Waste Technical Review Board (member)  |
| 75  | Kevin Kamps          | Beyond Nuclear  |
| 76  | Anthony Kluk         | DOE/Office of Environmental Management  |
| 77  | Lawrence Kokajko     | NRC/Division of High Level Waste Repository Safety  |
| 78  | Leonard Konikow      | U.S. Geological Survey  |
| 79  | Christopher Kouts    | DOE/Office of Civilian Radioactive Waste Management   |
| 80  | Steven Kraft         | Nuclear Energy Institute  |
| 81  | Darrell Lacy         | Nye County, State of Nevada   |
| 82  | Gary Lanthrum        | DOE/Office of Civilian Radioactive Waste Management   |
| 83  | Doug Larson          | Western Interstate Energy Board   |
| 84  | Ned Larson           | DOE/Office of Civilian Radioactive Waste Management   |
| 85  | Ronald M. Latanision | U.S. Nuclear Waste Technical Review Board (member)  |
| 86  | Thomas Leschine      | University of Washington  |
| 87  | Adam H. Levin        | Exelon Corporation  |
| 88  | David Little         | Washington Savannah River Company <sup>e</sup>  |
| 89  | David Lochbaum       | Union of Concerned Scientists   |
| 90  | Bob Loux             | Consultant  |
| 91  | Edwin Lyman          | Union of Concerned Scientists   |
| 92  | Allison Macfarlane   | George Mason University   |
| 93  | Arjun Makhijani      | Institute for Energy and Environmental Research   |
| 94  | Zita Martin          | Tennessee Valley Authority  |
| 95  | Rodney McCullum      | Nuclear Energy Institute  |
| 96  | John McKenzie        | Department of Defense/Department of the Navy  |
| 97  | Richard A. Meserve   | Carnegie Institution for Science<br>Nuclear and Radiation Studies Board, National Research Council of the National Academies                              |
| 98  | Barry Miles          | Department of Defense/Department of the Navy  |
| 99  | Thomas Minvielle     | Department of Defense/Department of the Navy  |
| 100 | Bob Mitchell         | Yankee Rowe   |
| 101 | Ali Mosleh           | U.S. Nuclear Waste Technical Review Board (member)  |
| 102 | William M. Murphy    | U.S. Nuclear Waste Technical Review Board (member)  |
| 103 | Connie Nakahara      | Utah Department of Environmental Quality  |
| 104 | Irene Navis          | Clark County, Nevada  |
| 105 | Tara Neider          | Transnuclear, Inc.  |



**Appendix III: Nuclear Waste Management  
Experts We Interviewed**

|     | <b>Name</b>           | <b>Affiliation</b>                                       |
|-----|-----------------------|--|
| 106 | Brian O'Connell       | National Association of Regulatory Utility Commissioners |
| 107 | Mary Olson            | Nuclear Information and Resource Service                 |
| 108 | Pierre Oneid          | Holtec International                                     |
| 109 | Ronald S. Osteen      | DOE/Office of Environmental Management                   |
| 110 | Jean Ridley           | DOE/Office of Environmental Management                   |
| 111 | John Parkyn           | Private Fuel Storage                                     |
| 112 | Stan Pedersen         | Bechtel SAIC Company, LLC <sup>b</sup>                   |
| 113 | Charles W. Pennington | NAC International  |
| 114 | Mark Peters           | Argonne National Laboratory                              |
| 115 | Per Peterson          | University of California at Berkeley                     |
| 116 | Henry Petroski        | U.S. Nuclear Waste Technical Review Board (member)       |
| 117 | Max Power             | Oregon Hanford Cleanup Board                             |
| 118 | Kenneth Powers        | DOE/Office of Civilian Radioactive Waste Management      |
| 119 | Jay Ray               | DOE/Office of Environmental Management                   |
| 120 | Jeffrey Ray           | Washington Savannah River Company <sup>c</sup>           |
| 121 | Everett Redmond II    | Nuclear Energy Institute                                 |
| 122 | James Robert          | Tennessee Valley Authority                               |
| 123 | Gene Rowe             | U.S. Nuclear Waste Technical Review Board (staff)        |
| 124 | Karyn Severson        | U.S. Nuclear Waste Technical Review Board (staff)        |
| 125 | David Shoesmith       | University of Western Ontario                            |
| 126 | Linda Sikkema         | National Conference of State Legislators                 |
| 127 | Kris Singh            | Holtec International                                     |
| 128 | Brian M. Smith        | Department of Defense/Department of the Navy             |
| 129 | Susan Smith           | DOE/Office of Civilian Radioactive Waste Management      |
| 130 | Joseph D. Sukaskas    | Maine Public Utilities Commission                        |
| 131 | Jane Summerson        | DOE/Office of Civilian Radioactive Waste Management      |
| 132 | Eileen Supko          | Energy Resources International, Inc.                     |
| 133 | Bill Swift            | Washington Savannah River Company <sup>c</sup>           |
| 134 | Peter Swift           | Sandia National Laboratories                             |
| 135 | Raymond Termini       | Exelon Corporation                                       |
| 136 | Mike Thorne           | Mike Thorne and Associates Limited                       |
| 137 | John Till             | Risk Assessment Corporation                              |
| 138 | Richard Tosetti       | Bechtel SAIC Company, LLC <sup>b</sup>                   |
| 139 | Brian Wakeman         | Dominion Resources, Inc.                                 |
| 140 | John Weiss, Jr.       | Entergy Corporation                                      |
| 141 | Christopher U. Wells  | Southern States Energy Board                             |
| 142 | Chris Whipple         | ENVIRON International Corporation                        |

---

**Appendix III: Nuclear Waste Management  
Experts We Interviewed**

|     | <b>Name</b>       | <b>Affiliation</b>  |
|-----|-------------------|---|
| 143 | James Williams    | Western Interstate Energy Board   |
| 144 | Wayne Worthington | Progress Energy   |
| 145 | David Zabransky   | DOE/Civilian Radioactive Waste Management Board   |
| 146 | Paul L. Ziemer    | Purdue University (retired)<br>Nuclear and Radiation Studies Board, National Research Council of the National Academies |
| 147 | Louis Zeller      | Blue Ridge Environmental Defense League   |

Source: GAO.

<sup>a</sup>On August 1, 2008, Savannah River Nuclear Solutions, LLC replaced Washington Savannah River Company as the primary contractor for DOE's Savannah River site. Expert affiliation was with Washington Savannah River Company at the time of our interviews.

<sup>b</sup>On April 1, 2009, USA Repository Services, LLC, replaced Bechtel SAIC Company, LLC, as the primary contractor for the Yucca Mountain repository. Expert affiliation was with Bechtel SAIC Company, LLC at the time of our interviews.

<sup>c</sup>On July 1, 2009, Savannah River Remediation, LLC replaced Washington Savannah River Company as the liquid waste program contractor. Expert affiliation was with Washington Savannah River Company at the time of our interviews.

---

# Appendix IV: Modeling Methodology, Assumptions, and Results

---

The methodology and results of the models we developed to analyze the total costs of two alternatives for managing nuclear waste are based on cost data and assumptions we gathered from experts. Specifically, this appendix contains information on the following:

- The modeling methodology we developed to generate a range of total costs for the two nuclear waste management alternatives with two different volumes of waste.
- The Monte Carlo simulation process we used to address uncertainties in input data.
- The discounting methodology we developed to derive the present value of total costs in 2009 dollars.
- The individual models and scenarios within each model.
- The results of our cost estimations for each scenario.
- Caveats to our modeling work.

Appendixes I and II describe our methodology for collecting cost data and assumptions and how we ensured their reliability.

---

## Modeling Methodology

The general framework for our models was an Excel spreadsheet that annually tracked all costs associated with packaging, transportation, construction, operation, and maintenance of nuclear waste facilities as well as repackaging of nuclear waste every 100 years when applicable. The starting time period for all models was the year 2009, but the end dates vary depending on the specifics of the scenario. The cost inputs were collected in constant 2008 dollars, but the range of total costs for each scenario was converted to and reported in 2009 present value dollars. Our analysis began with an estimate of existing and future annual volume of nuclear waste ready to be packaged and stored. We chose to model two amounts of waste: 70,000 metric tons and 153,000 metric tons.<sup>1</sup> For ease of

---

<sup>1</sup>The 70,000 metric tons is the statutory limit placed on the amount of waste that can be disposed of at Yucca Mountain. The 153,000 metric tons is the estimated amount of current waste plus additional commercial spent nuclear fuel that would be generated by 2055 if all currently operating commercial reactors received license extensions.

calculation, we converted all input costs to cost per-metric-ton of waste, when applicable.

The total cost range for each scenario was developed in four steps. First, we developed the total costs for commercial spent nuclear fuel volumes of about 63,000 metric tons and 140,000 metric tons, respectively. Second, we added DOE cost data for its managed waste.<sup>2</sup> Third, we discounted all annual costs to 2009 present value by a discounting methodology discussed later in this appendix. Finally, for scenarios where we assumed that the waste would be moved to a permanent repository after 100 years, we added DOE's cost estimate for the Yucca Mountain repository to represent cost for a permanent repository.<sup>3</sup> To ensure compatibility of cost data that DOE provided with cost ranges generated by our models, we converted DOE cost data to 2009 present value.

---

## Monte Carlo Simulation Process

To address the uncertainties inherent in our analysis, we used a commercially available risk analysis software program called Crystal Ball to incorporate uncertainties associated with the data. This program allowed us to explore a wide range of possible values for all the input costs and assumptions we used to build our models. The Crystal Ball program uses a Monte Carlo simulation process, which repeatedly and randomly selects values for each input to the model from a distribution specified by the user. Using the selected values for cells in the spreadsheet, Crystal Ball then calculates the total cost of the scenario. By repeating the process in thousands of trials, Crystal Ball produces a range of estimated total costs for each scenario as well as the likelihood associated with any specific value in the range.

---

<sup>2</sup>DOE management costs include spent nuclear fuel managed at the Hanford Reservation, Idaho National Laboratory, and Fort St. Vrain, in Colorado, and high-level waste at the Hanford Reservation, Savannah River Site, Idaho National Laboratory, and West Valley.

<sup>3</sup>We used DOE estimates for Yucca Mountain to represent the cost of a permanent repository. We, however, did not include historical costs for Yucca Mountain as we felt that these historical costs represent challenges unique to Yucca Mountain and may not be applicable to a future repository whereas the bulk of future cost for construction, operation, and closure would be replicated for a new repository.

---

## Discount Rates and Present Value Analysis

One of the inherent difficulties in developing the cost for a nuclear waste disposal option is that costs are spread over thousands of years. The economic concept of discounting is central to such analyses as it allows costs incurred in the distant future to be converted to present equivalent worth. We selected discount rates primarily based on results of studies published in peer reviewed journals. That is, rather than subjectively selecting a single discount rate, we developed our discounting approach based on a methodology and values for discount rates that were recommended by a number of published studies.

We selected studies that addressed issues related to discounting activities whose costs and effects spread across the distant future or many generations, also known as “intergenerational discounting.” In general, we found that these studies were in near consensus on two points: (1) discounting is an appropriate methodology when analyzing projects and policies that span many generations and (2) rates for discounting the distant future should be lower than near term discount rates and/or should decline over time. However, we found no consensus among the studies as to any specific discount rate that should be used. Consequently, we developed a discounting methodology using the following steps:

- We divided the entire time frame of our analysis into five different discounting intervals: immediate, near future, medium future, far future, and far-far future.
- We assumed that within each interval the discount rates were distributed with a triangular distribution.
- Based on all published rates, we developed the maximum, minimum, and mode values for each of the five specified intervals.
- We discounted all costs, using Crystal Ball to randomly and repeatedly select a rate from the appropriate interval and discount cost values using a different rate for each trial.
- Using these steps, we discounted all annual costs to 2009 present value.

Our methodology builds on a wide range of published rates from a number of different sources in concert with the Crystal Ball program. This enabled us, to the extent possible, to address the general lack of consensus on any specific discount rate and, at the same time, address the uncertainties that were inherent in intergenerational discounting and long-term analyses of nuclear waste management alternatives.

---

## Individual Models

We developed the following four models to estimate the cost of several hypothetical nuclear waste disposal alternatives, and we incorporated a number of scenarios within each model to address all uncertainties that we could not easily capture with Crystal Ball:

- **Model I:** Centralized storage for 153,000 metric tons, which included the following scenarios:
  - *Scenario 1:* Centralized storage for 100 years.
  - *Scenario 2:* Centralized storage for 100 years plus a permanent repository after 100 years.
- **Model II:** Centralized storage for 70,000 metric tons, which included one scenario:
  - *Scenario 1:* Centralized storage for 100 years.
- **Model III:** On-site storage using total waste volume of 153,000 metric tons which included the following scenarios:
  - *Scenario 1:* On-site storage for 100 years.
  - *Scenario 2:* On-site storage for 100 years plus a permanent repository after 100 years.
  - *Scenario 3:* On-site storage for 500 years.
- **Model IV:** On-site storage using total waste volume of 70,000 metric tons, which included one scenario:
  - *Scenario 1:* On-site storage for 100 years.

---

### Model I: Centralized Storage (153,000 metric tons)

For this model we assumed that nuclear waste would remain on site until interim facilities are constructed and ready to receive the waste. Two centralized storage facilities would be constructed over 3 years—from 2025 through 2027—and then start accepting waste. The first scenario for this model includes the costs to store waste at the centralized facilities through 2108. In the second scenario, these facilities would stay in

operation through 2155, or 47 years after a permanent repository for the waste would become available. The total analysis period for the cost of this alternative plus permanent repository continues until 2240, when a permanent repository would be expected to close. In general, the costs include the following:

- Initial costs, which include costs of casks, costs for loading of casks, cost of loading campaigns, and operating and maintenance costs by three types of nuclear sites, i.e., operating sites with dry storage, decommissioned sites with dry storage, and decommissioned sites with wet storage. The uncertainty ranges for these costs were from plus or minus 5 percent to plus or minus 50 percent, depending on specific cost variable.
- Costs associated with centralized facilities, including construction costs for centralized facilities, transportation cost for transfer of nuclear waste to centralized facilities, capital and operation and maintenance costs for transportation of waste to centralized facilities and operation and maintenance of centralized facilities. The uncertainty ranges for these costs are from plus or minus 10 percent to plus or minus 40 percent, depending on the cost category.

Figure 6: Scenario and Cost Time Frames for the Centralized 153,000 Metric Ton Models

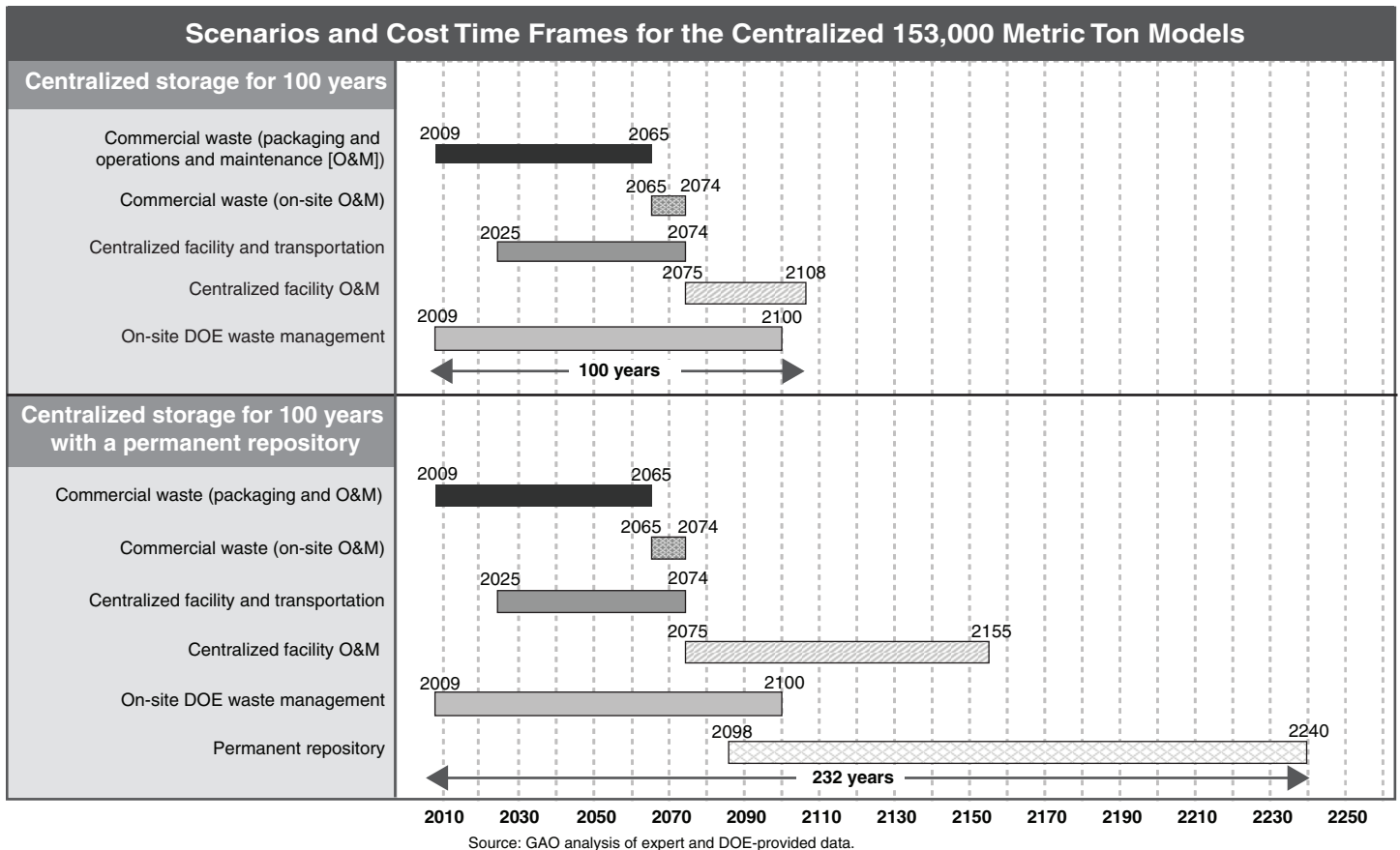

**Model II: Centralized Storage (70,000 metric tons)**

This model was developed under the assumption that total existing and newly generated waste from the private sector and DOE will be 70,000 metric tons. The stream of new annual waste ready to be moved to dry storage will continue through 2030. The cost categories and uncertainty ranges assumed for this storage alternative are the same as those assumed in the centralized storage model for 153,000 metric tons.



Figure 7: Scenario and Cost Time Frames for the Centralized 70,000 Metric Ton Model

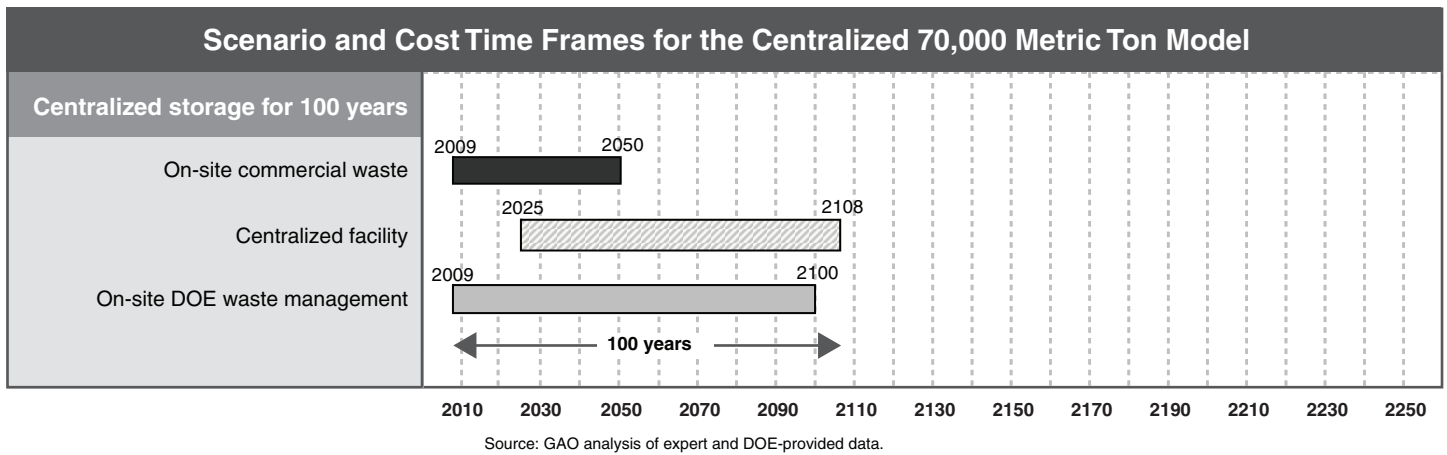

### Model III: On-Site Storage (153,000 metric tons)

We developed this model under the assumption that total existing and newly generated nuclear waste by the private sector and DOE would be 153,000 metric tons. The stream of new waste ready to be moved to dry storage would continue through 2065. In general, the costs include the following:

- Initial costs, which include costs of casks, costs for loading of casks, cost of loading campaigns, and operating and maintenance costs by three types of nuclear sites, i.e., operating sites with dry storage, decommissioned sites with dry storage, and decommissioned sites with wet storage. The uncertainty ranges for these costs were from plus or minus 5 percent to plus or minus 50 percent, depending on specific cost variable.
- Repackaging costs, which include the costs for casks; construction of transfer facilities, site pools, and other needed infrastructure; and repackaging campaigns. Because these costs are first incurred after 100 years and then every 100 years thereafter, they are included only in the model scenarios covering more than 100 years. The uncertainty for these costs range from plus or minus 10 percent to plus or minus 50 percent, depending on the specific cost variable.
- Dry storage pad costs, including initial costs when dry storage is first established, as well as replacement costs. Because the replacement costs are first incurred after 100 years and then every 100 years thereafter, they are included only in the model scenarios covering more than 100 years. The cost of these pads, collectively referred to as independent spent fuel

storage installations, include costs related to licensing, design, and construction of dry storage. The independent spent nuclear fuel storage installation costs have an uncertainty range of plus or minus 40 percent.

Figure 8: Scenarios and Cost Time Frames for the On-Site 153,000 Metric Ton Models

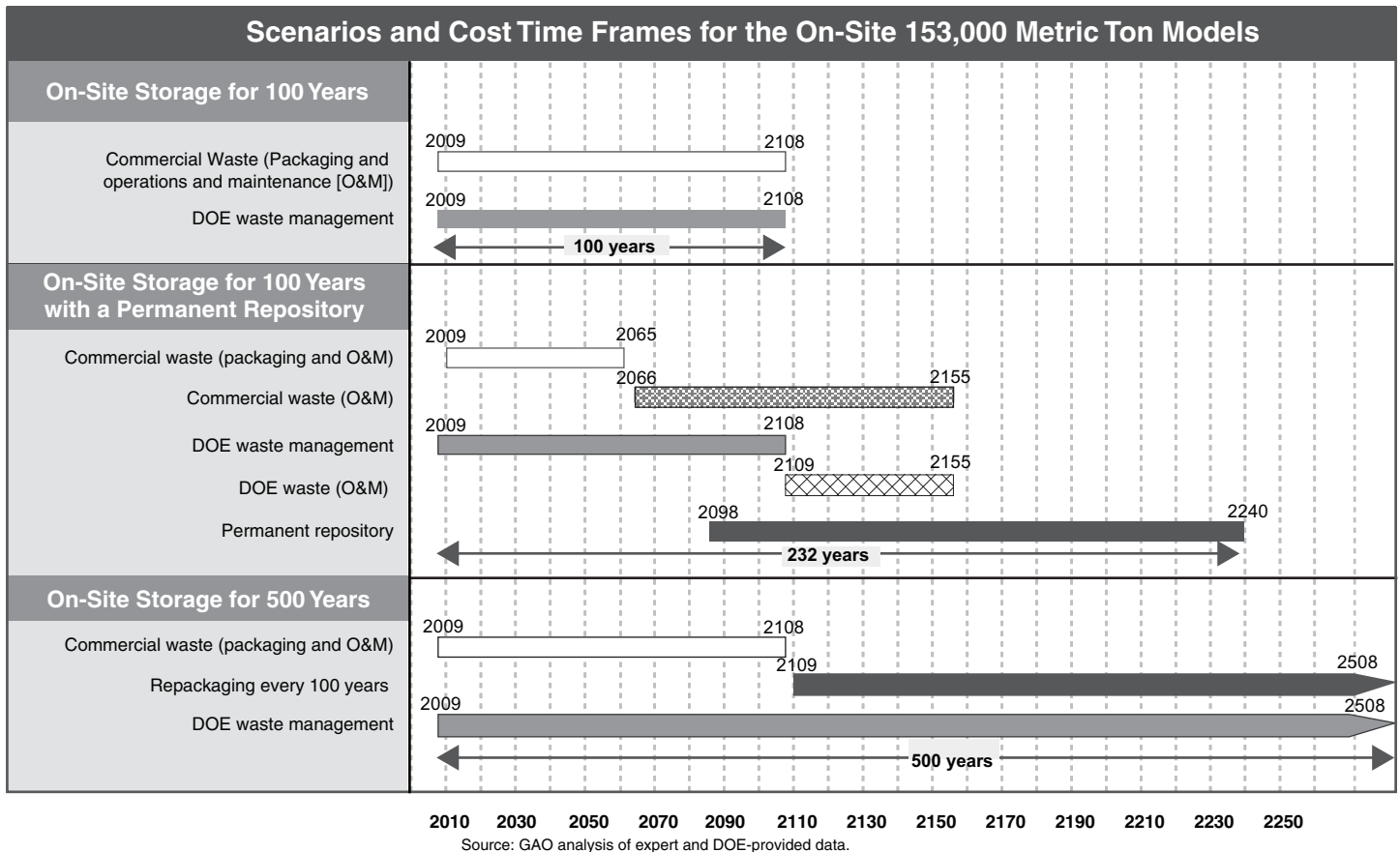

Model IV: On-Site Storage (70,000 metric tons)

We developed this model under the assumption that total existing and newly generated nuclear waste by the private sector and DOE will be 70,000 metric tons. The stream of new annual waste ready to be moved to dry storage will continue through 2030. The cost categories and uncertainty ranges assumed for this storage alternative are the same as those for the on-site model for storing 153,000 metric tons for 100 years.

Figure 9: Scenario and Cost Time Frames for the On-Site 70,000 Metric Ton Model

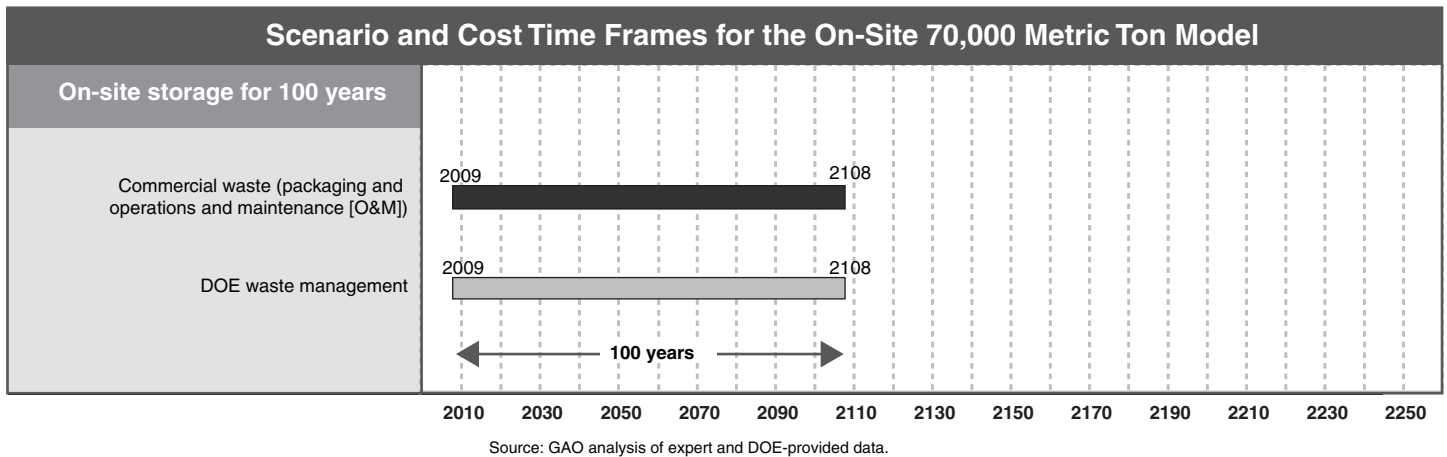

## Costs for a Permanent Repository

For two scenarios, we assumed that at the end of 100 years the nuclear waste would be transferred to a permanent repository for disposal. To estimate the cost for a repository, we used DOE's cost data for the Yucca Mountain repository and made three adjustments to ensure compatibility with costs generated by our models. First, we included only DOE's future cost estimates for the Yucca Mountain repository. Second, because DOE provided costs in 2008 constant dollars, we converted all costs for the permanent repository to costs to 2009 present value using corresponding ranges of interest rates as previously described in this appendix. Finally, we assumed that repository construction and operating costs would be incurred from 2098 to 2240 when we added these cost ranges to our alternatives after 100 years.

## Modeling Results

Table 8 shows the results of our analysis for all scenarios.

**Table 8: Model Results for All Scenarios**

| Dollars in billions                                       |                                   |                   |
|---|-----------------------------------|-------------------|
| Models and scenarios                                      | Range of total costs <sup>a</sup> | Mean <sup>a</sup> |
| <b>Permanent repository (153,000 metric tons)</b>         |                                   |                   |
| Permanent repository <sup>b</sup>                         | \$41 to \$67                      | \$53              |
| <b>Permanent repository (70,000 metric tons)</b>          |                                   |                   |
| Permanent repository <sup>b</sup>                         | \$27 to \$39                      | \$32              |
| <b>Model I: centralized storage (153,000 metric tons)</b> |                                   |                   |
| Centralized 100 years                                     | \$15 to \$29                      | \$21              |
| Centralized 100 years plus permanent repository           | \$23 to \$81                      | \$47              |
| <b>Model II: centralized storage (70,000 metric tons)</b> |                                   |                   |
| Centralized 100 years                                     | \$12 to \$20                      | \$15              |
| <b>Model III: on-site storage (153,000 metric tons)</b>   |                                   |                   |
| On-site 100 years   | \$13 to \$34                      | \$22              |
| On-site 100 years plus permanent repository               | \$20 to \$97                      | \$51              |
| On-site for 500 years                                     | \$34 to \$225                     | \$89              |
| <b>Model IV: on-site storage (70,000 metric tons)</b>     |                                   |                   |
| On-site 100 years   | \$10 to \$26                      | \$18              |

Source: GAO.

Note: All costs are in 2009 present value and represent costs regardless of who will pay or is legally responsible to pay for them and as such do not address the issue of liabilities. Furthermore, these costs do not include other potential costs, such as decommissioning and environmental costs and the government's penalties for delays in moving waste from the Idaho National Laboratory under the settlement agreement with Idaho.

<sup>a</sup>The cost estimates do not present exact values rather order-of-magnitude estimates as both the maximum and minimum as well as mean values will be somewhat different each time the simulation is repeated. This is because the Monte Carlo methodology will randomly select a different set of input data from one simulation run to the next.

<sup>b</sup>While our cost ranges for a permanent repository are based on DOE's estimate for the Yucca Mountain repository, our cost ranges differ from DOE's of \$96 billion estimate for the following reasons: First, our cost ranges are in 2009 present value, while DOE uses 2007 constant dollars, which are not discounted. Our present value analysis reflects the time value of money—costs incurred in the future are worth less today—so that streams of future costs become smaller. Second, our cost ranges do not include about \$14 billion in previously incurred costs. Third, our cost ranges are for 153,000 metric tons and 70,000 metric tons of nuclear waste, while DOE's estimated cost is for 122,100 metric tons. Finally, we use ranges while DOE provides a point estimate.

Figures 10 and 11 show ranges of total costs, as well as the probabilities for two selected scenarios. In the figures, each bar indicates a range of values for total cost and the height of the each bar indicates the probability associated with those values.

**Figure 10: Total Cost Ranges for Centralized Storage for 100 Years with Final Disposition**

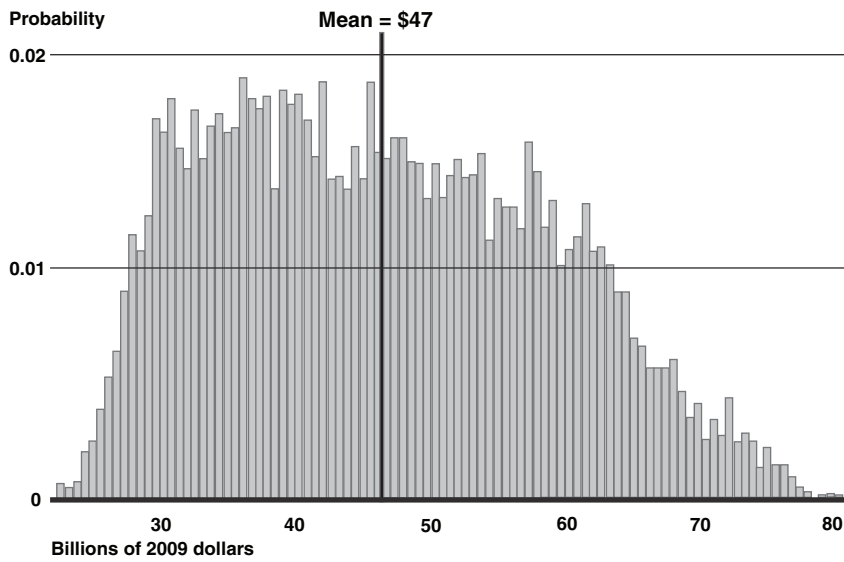

Source: GAO analysis of expert and DOE provided data.

Note: The values on the horizontal axis of the figure are to provide a scale and do not correspond exactly to the ranges for total costs which are provided in table 8.

**Figure 11: Total Cost Ranges for On-site Storage for 100 years with Final Disposition**

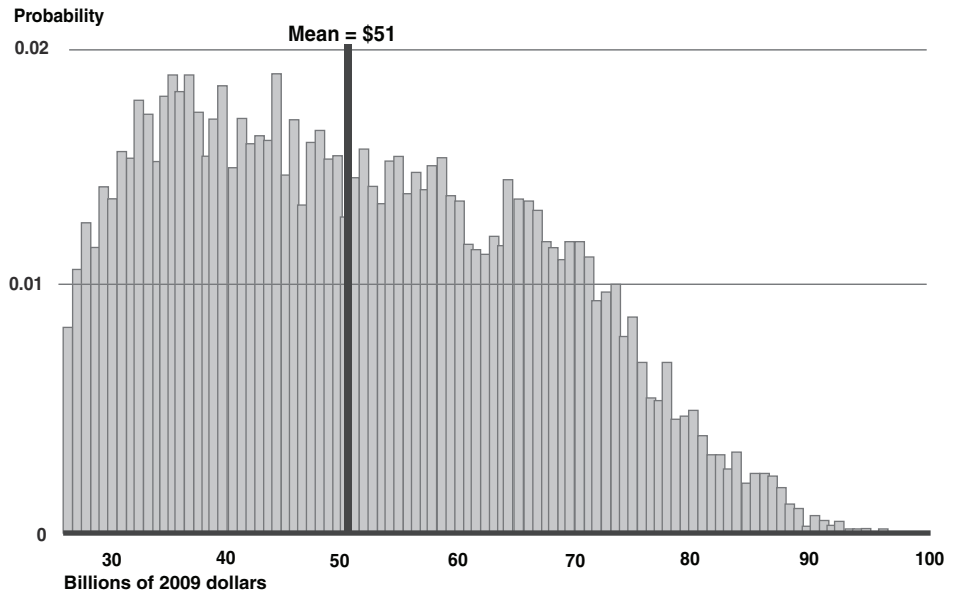

Source: GAO analysis of expert and DOE provided data.

Note: The values on the horizontal axis of the figure are to provide a scale and do not correspond exactly to the ranges for total costs which are provided in table 8.

Figure 12 shows the present value of the total cost ranges of storing the nuclear waste on site over 2,000 years. The shaded areas indicate the probability that the values fall within the indicated ranges and are the result of combinations of uncertainties from a large number of input data. Specifically, we estimate that these costs could range from \$34 billion to \$225 billion over 500 years, from \$41 billion to \$548 billion over 1,000 years, and from \$41 billion to \$954 billion over 2,000 years, indicating a substantial level of uncertainty in making long-term cost projections.

**Figure 12: Total Cost Ranges of On-Site Storage over 2,000 Years**

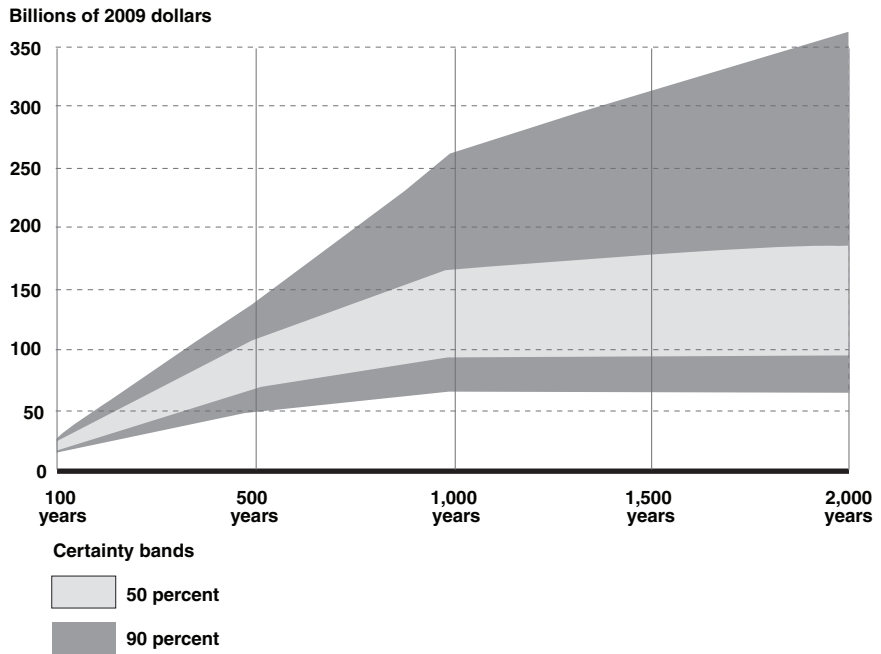

Source: GAO analysis of expert and DOE-provided data.

Note: The values on the vertical axis of the figure are to provide a scale and do not correspond exactly to the total cost ranges presented in table 8.

## Modeling Caveats

Our models are based on ranges of average costs for each major cost category that is applicable to the alternative under analysis. As a result, the costs do not reflect storage costs for any specific site. Since we did not attempt to capture specific characteristics of each site, our values for any cost factor, if applied to any specific site, are likely incorrect. Nevertheless, since we used ranges rather than single values for a wide range of cost inputs to the models, we expect that our cost range for each variable includes the true cost for any specific site. Moreover, we expect the total cost point estimate for any scenario is within the range of total costs we developed.

Our models are designed to develop total cost ranges for each scenario within each alternative, regardless of who will pay or is legally responsible for the costs. Issues related to assignment of the costs and potentially responsible entities are discussed elsewhere in this report but are not incorporated into our ranges. Also, our cost ranges focus on actual expenditures that would be incurred over the period of analysis and do not

assume a particular funding source and do not necessarily represent costs to the federal government. Finally, because a number of cost categories are not included in our final estimated ranges, we cannot predict their impact on our final costs ranges. For example, we did not include (1) decontamination and decommissioning costs for existing facilities or facilities yet to be built within each scenario and (2) estimates for local and state taxes or fees, which would be required to establish new sites or for continued operation of on-site storage facilities after nuclear reactors are decommissioned.

Table 8 and figures 10 and 11 present the results of our analysis by individual scenario. Because the purpose of our analysis was primarily to provide cost ranges for various nuclear waste management alternatives, we did not attempt to provide a comparison of results across scenarios. For a number of reasons, we believe such a comparison would have been misleading. The alternatives we have considered are inherently different in a large number of characteristics that could not be captured in our modeling work or they were not within the scope of our analysis. For example, differences in safety, health, and environmental effects, and ease of implementation characteristics of these alternatives should have an integral role in the policy debate on waste management decisions. However, because these effects cannot be readily quantified, they were outside the scope of our modeling work and are not reflected in the total cost ranges we generated.



# Appendix V: Comments from the Department of Energy



**Department of Energy**  
Washington, DC 20585

October 28, 2009

Mr. Mark E. Gaffigan  
Director, Natural Resources and Environment  
U.S. Government Accountability Office  
441 G Street, NW  
Washington, D.C. 20548

Dear Mr. Gaffigan:

Thank you for the opportunity to review and submit comments on the draft report, "NUCLEAR WASTE MANAGEMENT: Key Attributes, Challenges and Costs for the Yucca Mountain Repository and Two Potential Alternatives" (GAO-10-48). The U.S. Department of Energy appreciates the amount of time and effort that you and your staff have taken to review this important topic.

Specific comments from Naval Reactors, the Office of General Counsel, and the Office of Environmental Management on the draft report are enclosed. If you have any questions, please feel free to call me on 202-586-6850.

Sincerely,

A handwritten signature in black ink, appearing to read "Christopher A. Kouts".

Christopher A. Kouts  
Acting Director  
Office of Civilian Radioactive  
Waste Management

Enclosure



Printed with soy ink on recycled paper

---

# Appendix VI: Comments from the Nuclear Regulatory Commission

---



UNITED STATES  
NUCLEAR REGULATORY COMMISSION  
WASHINGTON, D.C. 20555-0001

October 26, 2009

Mr. Richard Cheston  
Assistant Director  
U.S. Government Accountability Office  
441 G Street, N.W.  
Washington, DC 20548

Dear Mr. Cheston:

Thank you for providing the U.S. Nuclear Regulatory Commission (NRC) the opportunity to review and comment on the U.S. Government Accountability Office's (GAO) draft report GAO-10-48, "NUCLEAR WASTE MANAGEMENT – Key Attributes, Challenges, and Costs for the Yucca Mountain Repository and Two Potential Alternatives." The NRC staff has reviewed the draft report. Although we did not identify any significant issues regarding accuracy, completeness, or sensitivity of information, we have separately transmitted several technical and editorial comments to your staff.

If you have any questions regarding this response, please contact Mr. Jesse Arildsen of my staff, at (301) 415-1785.

Sincerely,

A handwritten signature in cursive script, appearing to read "R. W. Borchardt".

R. W. Borchardt  
Executive Director  
for Operations

Enclosure:  
NRC Staff Comments on Draft  
Report GAO-10-48

---

# Appendix VII: GAO Contact and Staff Acknowledgments

---

## GAO Contact

Mark Gaffigan, (202) 512-3841 or [gaffiganm@gao.gov](mailto:gaffiganm@gao.gov)

---

## Staff Acknowledgments

In addition to the individual named above, Richard Cheston, Assistant Director; Robert Sánchez; Ryan Gottschall; Carol Henn; Anne Hobson; Anne Rhodes-Kline; Mehrzad Nadji; Omari Norman; and Benjamin Shouse made key contributions to this report. Also contributing to this report were Nancy Kingsbury, Karen Keegan, and Timothy Persons.

---

## GAO's Mission

The Government Accountability Office, the audit, evaluation, and investigative arm of Congress, exists to support Congress in meeting its constitutional responsibilities and to help improve the performance and accountability of the federal government for the American people. GAO examines the use of public funds; evaluates federal programs and policies; and provides analyses, recommendations, and other assistance to help Congress make informed oversight, policy, and funding decisions. GAO's commitment to good government is reflected in its core values of accountability, integrity, and reliability.

---

## Obtaining Copies of GAO Reports and Testimony

The fastest and easiest way to obtain copies of GAO documents at no cost is through GAO's Web site ([www.gao.gov](http://www.gao.gov)). Each weekday afternoon, GAO posts on its Web site newly released reports, testimony, and correspondence. To have GAO e-mail you a list of newly posted products, go to [www.gao.gov](http://www.gao.gov) and select "E-mail Updates."

---

## Order by Phone

The price of each GAO publication reflects GAO's actual cost of production and distribution and depends on the number of pages in the publication and whether the publication is printed in color or black and white. Pricing and ordering information is posted on GAO's Web site, <http://www.gao.gov/ordering.htm>.

Place orders by calling (202) 512-6000, toll free (866) 801-7077, or TDD (202) 512-2537.

Orders may be paid for using American Express, Discover Card, MasterCard, Visa, check, or money order. Call for additional information.

---

## To Report Fraud, Waste, and Abuse in Federal Programs

Contact:

Web site: [www.gao.gov/fraudnet/fraudnet.htm](http://www.gao.gov/fraudnet/fraudnet.htm)

E-mail: [fraudnet@gao.gov](mailto:fraudnet@gao.gov)

Automated answering system: (800) 424-5454 or (202) 512-7470

---

## Congressional Relations

Ralph Dawn, Managing Director, [dawnr@gao.gov](mailto:dawnr@gao.gov), (202) 512-4400  
U.S. Government Accountability Office, 441 G Street NW, Room 7125  
Washington, DC 20548

---

## Public Affairs

Chuck Young, Managing Director, [youngc1@gao.gov](mailto:youngc1@gao.gov), (202) 512-4800  
U.S. Government Accountability Office, 441 G Street NW, Room 7149  
Washington, DC 20548

