

# Nuclear Energy and Renewables

System Effects in Low-carbon  
Electricity Systems





# **Nuclear Energy and Renewables: System Effects in Low-carbon Electricity Systems**

© OECD 2012  
NEA No. 7056

NUCLEAR ENERGY AGENCY  
ORGANISATION FOR ECONOMIC CO-OPERATION AND DEVELOPMENT

## ORGANISATION FOR ECONOMIC CO-OPERATION AND DEVELOPMENT

The OECD is a unique forum where the governments of 34 democracies work together to address the economic, social and environmental challenges of globalisation. The OECD is also at the forefront of efforts to understand and to help governments respond to new developments and concerns, such as corporate governance, the information economy and the challenges of an ageing population. The Organisation provides a setting where governments can compare policy experiences, seek answers to common problems, identify good practice and work to co-ordinate domestic and international policies.

The OECD member countries are: Australia, Austria, Belgium, Canada, Chile, the Czech Republic, Denmark, Estonia, Finland, France, Germany, Greece, Hungary, Iceland, Ireland, Israel, Italy, Japan, Luxembourg, Mexico, the Netherlands, New Zealand, Norway, Poland, Portugal, the Republic of Korea, the Slovak Republic, Slovenia, Spain, Sweden, Switzerland, Turkey, the United Kingdom and the United States. The European Commission takes part in the work of the OECD.

OECD Publishing disseminates widely the results of the Organisation's statistics gathering and research on economic, social and environmental issues, as well as the conventions, guidelines and standards agreed by its members.

*This work is published on the responsibility of the OECD Secretary-General.*

### NUCLEAR ENERGY AGENCY

The OECD Nuclear Energy Agency (NEA) was established on 1 February 1958. Current NEA membership consists of 30 OECD member countries: Australia, Austria, Belgium, Canada, the Czech Republic, Denmark, Finland, France, Germany, Greece, Hungary, Iceland, Ireland, Italy, Japan, Luxembourg, Mexico, the Netherlands, Norway, Poland, Portugal, the Republic of Korea, the Slovak Republic, Slovenia, Spain, Sweden, Switzerland, Turkey, the United Kingdom and the United States. The European Commission also takes part in the work of the Agency.

The mission of the NEA is:

- to assist its member countries in maintaining and further developing, through international co-operation, the scientific, technological and legal bases required for a safe, environmentally friendly and economical use of nuclear energy for peaceful purposes, as well as
- to provide authoritative assessments and to forge common understandings on key issues, as input to government decisions on nuclear energy policy and to broader OECD policy analyses in areas such as energy and sustainable development.

Specific areas of competence of the NEA include the safety and regulation of nuclear activities, radioactive waste management, radiological protection, nuclear science, economic and technical analyses of the nuclear fuel cycle, nuclear law and liability, and public information.

The NEA Data Bank provides nuclear data and computer program services for participating countries. In these and related tasks, the NEA works in close collaboration with the International Atomic Energy Agency in Vienna, with which it has a Co-operation Agreement, as well as with other international organisations in the nuclear field.

This document and any map included herein are without prejudice to the status of or sovereignty over any territory, to the delimitation of international frontiers and boundaries and to the name of any territory, city or area.

Corrigenda to OECD publications may be found online at: [www.oecd.org/publishing/corrigenda](http://www.oecd.org/publishing/corrigenda).

© OECD 2012

You can copy, download or print OECD content for your own use, and you can include excerpts from OECD publications, databases and multimedia products in your own documents, presentations, blogs, websites and teaching materials, provided that suitable acknowledgment of the OECD as source and copyright owner is given. All requests for public or commercial use and translation rights should be submitted to [rights@oecd.org](mailto:rights@oecd.org). Requests for permission to photocopy portions of this material for public or commercial use shall be addressed directly to the Copyright Clearance Center (CCC) at [info@copyright.com](mailto:info@copyright.com) or the Centre français d'exploitation du droit de copie (CFC) [contact@cfcopies.com](mailto:contact@cfcopies.com).

Cover photos: Electricity pylon, France (F. Vuillaume, OECD/NEA); Brokdorf nuclear power plant, Germany (Alois Staudacher); solar panels.

## Foreword

Electricity generating power plants do not exist in isolation. They interact with each other and their customers through the electricity grid as well as with the wider economic, social and natural environment. This means that electricity production generates costs beyond the perimeter of the individual plant. Such external costs or system costs can take the form of intermittency, network congestion or greater instability but can also affect the quality of the natural environment or pose risks in terms of the security of supply. System costs in this study are defined as the total costs above plant-level costs to supply electricity at a given load and given level of security of supply.

Accounting for such system costs can make significant differences to the social and private investor costs of different power generation technologies. Not accounting for them implies hidden costs that can, if not adequately anticipated, pose threats to the security of electricity supply in the future. The present study continues the work of the OECD Nuclear Energy Agency (NEA) on the full costs of electricity generation in the wake of recent reports on *Projected Costs of Generating Electricity* (2010), *The Security of Energy Supply and the Contribution of Nuclear Energy* (2010) and *Carbon Pricing, Power Markets and the Competitiveness of Nuclear Power* (2011).

While the study analyses the system costs of all power generation technologies, it concentrates on the system effects of nuclear power and variable renewables, such as wind and solar PV, as their interaction is becoming increasingly important in the decarbonising electricity systems of OECD countries. In particular, the integration of significant amounts of variable renewables is a complex issue that profoundly affects the structure, financing and operational mode of electricity systems in general and nuclear in particular. System costs also vary strongly between different countries due to differences in the generation mix, the share of variable renewables and the shape of the daily and seasonal load curves.

The study focuses on grid-level system costs that are composed of the costs for network connection, extension and reinforcement, short-term balancing and long-term adequacy in order to ensure continuous matching of supply and demand under all circumstances. Such grid-level costs are real monetary costs that are already being borne today by network operators, dispatchable power producers using nuclear, coal or gas, as well as electricity customers. An important contribution of this study is the first systematic quantification of such grid-level system costs for six OECD/NEA countries (Finland, France, Germany, the Republic of Korea, the United Kingdom and the United States). Including system costs increases the total costs of variable renewables, depending on technology, country and penetration levels, by up to one-third.

The study also looks at total system costs in a qualitative manner. This broader set of system cost would include local and global environmental externalities, impacts on the security of energy supply and a country's strategic position as well as other positive or negative spillover effects relating to technological innovation, economic development, accidents, waste, competitiveness or exports. In addition, the study also considers the ability of nuclear energy to contribute to the internalisation of the system costs generated by intermittency in low-carbon electricity systems.

In addition, the study examines the important "pecuniary externalities" or financial impacts that the introduction of variable renewables has on the profitability of dispatchable technologies both in the short run and in the long run. In the short run, with the current structure of the power generation mix remaining in place, all dispatchable technologies, nuclear, coal and gas, will suffer due to lower average electricity prices and reduced load factors ("compression effect"). Due to its lower variable costs, however, existing nuclear power plants will do relatively better than gas and coal plants. In particular, gas plants are already experiencing substantial declines in profitability in several OECD/NEA countries

with high shares of variable renewables. In the future, dispatchable technologies, including nuclear, will require that a portion of their revenues be derived from other sources than “energy-only” electricity markets if they are to stay in the market and provide the necessary back-up services. Capacity payments or markets with capacity obligations will play an important part in addressing this issue.

In the long run, nuclear energy will be affected disproportionately by the increased difficulties to finance large fixed-cost investments in volatile low-price environments. This can have significant impacts on the carbon intensity of power generation. If, for instance, such baseload is currently produced by nuclear power, replacing the latter in the future by a mix of variable renewables and gas will mean that carbon emissions will rise rather than fall.

System costs, both technical costs at the grid level and pecuniary impacts, vary strongly between countries, depending on the amount of variable renewables being introduced, local conditions and the level of carbon prices. The latter are particularly important. While nuclear power has some system costs of its own, it remains the only major dispatchable low-carbon source of electricity other than hydropower which is in limited supply. Carbon prices will thus be an increasingly important tool to differentiate between low-carbon and high-carbon dispatchable technologies.

System costs are not only country-dependent, as a policy-relevant issue they are also a complex, relatively new phenomenon that poses a number of methodological challenges, not all of which have yet been resolved in a generally accepted manner. The present study provides a contribution to the debate, which is still ongoing. Further research is necessary and will undoubtedly refine both methodologies and empirical results. Nevertheless, by building on a systematic review of the available literature and by contributing some carefully considered methodological advances, the findings herein should help inform discussions.

The policy implications for governments are clear and unaffected by these methodological considerations. First, governments need to ensure the transparency of power generation costs at the system level. When making policy decisions affecting their electricity markets, countries need to consider the full system costs of different technologies.

Second, governments should prepare the regulatory frameworks to minimise system costs and favour their internalisation. This includes remunerating the capacity services of dispatchable technologies, allocating the costs for balancing, adequacy and grid connection in a fair and transparent manner and monitoring carefully the implications for carbon emissions of different strategic choices for back-up provision. Failure to do so will rebound in terms of unanticipated cost and environmental emission increases of the overall power supply for many years to come.

## Acknowledgements

This study was written by Professor Jan Horst Keppler and Dr. Marco Cometto, OECD/NEA Nuclear Development Division. Dr. Ron Cameron, Head of the OECD/NEA Nuclear Development Division, provided managerial oversight as well as substantial comment throughout the process. The work was overseen at all stages by the OECD/NEA Working Party on Nuclear Energy Economics (WPNE) chaired by Matthew Crozat (United States) and Professor Alfred Voss (Germany). The study was endorsed for publication by the OECD/NEA Nuclear Development Committee (NDC).

Several individuals made substantive contributions to different parts of the study. Philippe Lebreton (France) provided significant input to Chapter 2 “The Effects of Nuclear Power at the Level of the Electricity System”. The section on the load following capabilities of nuclear plants “The Flexibility Potential of Nuclear Power Plants in the Short Run” is based on earlier work by Dr. Alexey Likhov (OECD/NEA Nuclear Development Division). For Chapter 5 on “Regulatory Frameworks for the Internalisation of System Effects and the Adequate Remuneration of Flexibility Services” a first draft was prepared by Eduard Blanquet i Aragó (OECD/NEA Nuclear Development Division). Section 6.1 on “The Role of Smart Electricity Grids in Facilitating the Interaction between Intermittent Renewables and Nuclear Power in Integrated Electricity Systems” is based on a study by Dr. Dirk Van Hertem,

Dr. Erik Delarue, Dr. Leen Vandezande, Dr. Benjamin Dupont, Dr. Frederik Geth, Dr. Jeroen Büscher, Professor William D'haeseleer and Professor Ronnie Belmans of the Energy Institute of K.U. Leuven (Belgium) prepared for the WPNE. Section 6.2 on “The Economic Potential of Small Modular Reactors in Integrated Electricity Systems” is based on a study by Dr. Sara Boarin, Professor Marco Ricotti and Professor Marco Mancini of Politecnico Milano for the WPNE. Finally, Chapter 7 on “Modelling the System-wide Interaction of Nuclear Power and Renewables: A Case Study of Germany” was contributed to the work of the WPNE by Dr. Rüdiger Barth, Dr. Heike Brand, Dr. Jürgen Apfelbeck and Professor Alfred Voß, Institute for Energy Economics and the Rational Use of Energy, University of Stuttgart.

The authors would also like to thank the participants of two workshops on system cost issues, as well as the participants in the OECD/IEA/NEA Roundtable on the Integration of Intermittent Renewables in Decarbonising Electricity Systems, for their feedback and contributions. The members of the WPNE as well as the participants in the workshops and the roundtable are acknowledged in Annex 1.





## Table of contents

<b>Executive summary</b> .....	13
<b>Chapter 1</b> <b>Introduction: system effects between nuclear energy and variable renewables</b> .....	25
1.1 Why a study on the system effects of nuclear energy and variable renewables? ..	25
1.2 The nature of this study .....	26
1.3 Notions of system costs and their relation to externalities .....	30
1.4 The question of pecuniary externalities .....	34
1.5 A new role for nuclear energy .....	38
<b>Chapter 2</b> <b>The effects of nuclear power at the level of the electricity system</b> .....	43
2.1 Nuclear power plants as part of the electrical system .....	43
2.2 The siting issue .....	50
2.3 The importance of grid quality for nuclear power plants .....	56
2.4 Costs for a nuclear power plant .....	60
2.5 Conclusion .....	61
<b>Chapter 3</b> <b>The contribution of nuclear power to the minimisation of system effects in the short and long run</b> .....	65
3.1 The flexibility potential of nuclear power plants in the short run .....	67
3.2 Long-term management of nuclear power plant fleets to minimise system costs .....	89
3.3 Conclusion .....	100
<b>Chapter 4</b> <b>Determining and measuring the system costs of power generation</b> .....	103
4.1 System costs in the electricity sector: the system cost matrix .....	103
4.2 Quantitative estimation of system costs for selected OECD countries .....	121
4.3 De-optimisation of the generation mix and pecuniary externalities .....	132
<i>Appendix 4.A OECD system cost model</i> .....	143
<i>Appendix 4.B Supplementary tables and data</i> .....	149
<i>Appendix 4.C Calculation of the optimal generation mix using annual LOAD duration curve and residual duration curves</i> .....	151
<i>Appendix 4.D Changes in the optimal generation mix – a hidden system cost</i> .....	155

<b>Chapter 5</b>	<b>Regulatory frameworks for the internalisation of system effects and the adequate remuneration of flexibility services</b> .....	161
5.1	Introduction .....	161
5.2	Dispatchable back-up capacity, interconnections, storage and demand response: four options for the provision of flexibility services .....	162
5.3	Markets for managing variability and the provision of dispatchable capacity .....	172
5.4	Improving renewable support policies to reduce system effects .....	180
5.5	Conclusion .....	185
<b>Chapter 6</b>	<b>Future visions</b> .....	191
6.1	The role of smart electricity grids in facilitating the interaction between intermittent renewables and nuclear power in integrated electricity systems ...	191
6.2	The economic potential of small modular reactors in integrated electricity systems .....	202
<b>Chapter 7</b>	<b>Modelling the system-wide interaction of nuclear power and renewables: a case study of Germany</b> .....	213
7.1	Objective and background of this analysis .....	213
7.2	Methodology and presentation of the model .....	213
7.3	The case study .....	215
7.4	Summary .....	227
<i>Appendix 7.A</i>	Structure and working of the E2M2S and the JMM used in the modelling .....	229
<i>Appendix 7.B</i>	The impacts of the annual volatility of wind and solar generation .....	233
<b>Chapter 8</b>	<b>Lessons learnt and policy recommendations</b> .....	237
8.1	System effects: the need for policy action .....	237
8.2	On this study .....	238
8.3	Lessons learnt .....	240
8.4	Policy recommendations .....	242
<b>ANNEXES</b>		
	Members of the Working Party on Nuclear Energy Economics (WPNE) .....	245
	Acronyms .....	249
<b>FIGURES</b>		
ES.1	Plant-level, grid-level and total system costs .....	14
ES.2	Annual electricity supply costs in Germany as a function of different shares of variable renewables and nuclear .....	20
1.1	The impact of 35% renewable energy penetration in the western United States .....	28
1.2	Wind power and negative prices on the German electricity wholesale market .....	36
2.1	Hourly electricity demand curve in Texas (ERCOT) for 3 weeks in 2005 .....	45
2.2	System load following and frequency regulation .....	46

2.3	Activation of power reserves in the event of the disconnection of a large plant .....	48
2.4	Real margin versus theoretical margin (2010) .....	49
2.5	Illustration of frequency and voltage operating limits based on NORDEL grid code .....	50
2.6	Comparison of the total transport costs for fuel and electricity in Germany .....	53
3.1	Variability of demand and wind generation .....	66
3.2	Example of the electricity generation in France during 2 weeks in November 2010 .....	69
3.3	Example of the power history of a French PWR reactor engaged in load following .....	70
3.4	Load following operations of E.On nuclear units in Germany .....	71
3.5	General scheme of a PWR .....	74
3.6	Typical temperatures for a French 1300 PWR and a German PWR as a function of the power level.....	75
3.7	General scheme of a conventional BWR .....	75
3.8	VVER-1200 layout and the elements critical for the load following .....	80
3.9	Cracking of some PWR fuel pellets .....	82
3.10	Daily electricity prices on the EEX during 2005-2010 .....	85
3.11	Value of load flexibility .....	88
3.12	Value of load flexibility in 2009 for a production cost of EUR 15/MWh .....	89
3.13	Energy loss distribution in NPP (2006-2010) .....	91
3.14	Historic trend of nuclear capacity and electricity production .....	92
3.15	Evolution of load and availability factors in the 1980-2011 period.....	93
3.16	Electricity generation cost for baseload and wind power plants .....	94
3.17	LCOE variation as a function of the load factor (at 5% discount rate).....	94
3.18	Seasonal evolution of electricity demand and nuclear supply in France .....	98
3.19	Effect of seasonal management on the residual demand (including import/export) .....	98
4.1	Plant-level, grid-level and total system costs .....	104
4.2	Daily variations of wind energy in Spain over one year .....	109
4.3	Balancing costs as a function of the share of wind power .....	111
4.4	The declining contribution of increasing amounts of solar capacity to system capacity in the Californian CAISO system .....	112
4.5	SSDI of selected OECD countries between 1970 and 2007 .....	117
4.6	Direct and indirect CO <sub>2</sub> emissions of different power generation technologies .....	118
4.7	“To what extent do you think that nuclear power represents a risk to you and your family?” (EU 27, September-October 2009) .....	120
4.8	“Compared to other safety risks in our lives, would you say that nuclear risks are...?” (EU 27, September-October 2009).....	121
4.9	Plant- and grid-level costs for different technologies in the United Kingdom .....	128
4.10	Average annual cost of electricity supply – 10% penetration level .....	130
4.11	Average annual cost of electricity supply – 30% penetration level .....	130
4.12	Theoretical characterisation of the optimal generation mix.....	133

4.13	Lost load for existing power plants after the introduction of wind power at 30% penetration level – short-term effect .....	135
4.14	Optimal dispatchable power mix with and without variable renewables .....	137
4.15	Optimal generation mix in different scenarios .....	138
4.16	Long-term evolution of optimal capacity and electricity production for baseload technology (wind scenario at 10% penetration level) .....	139
4.17	Optimal nuclear capacity as a function of carbon price and renewable penetration level .....	140
4.1C	Load factor probability distribution for wind .....	152
4.2C	Assumed load factor variability for solar .....	152
4.3C	Residual duration curves .....	153
4.4C	Estimates of wind capacity credit at 30% penetration level in France .....	153
4.1D	Residual load duration curves and electricity generation cost with and without variable renewables: the case of 30% wind penetration .....	156
4.2D	Residual load duration curves and electricity generation cost with and without variable renewables: the case of solar 30% penetration .....	156
5.1	Old and new balancing challenges in the Nordic system .....	164
5.2	European objectives for interconnection capacity in 2020 (MW, PRIMES Reference Scenario) .....	167
5.3	The advantages of smart metering for different stakeholders .....	171
5.4	Regional electricity markets in the United States with mandatory capacity markets .....	174
5.5	The dynamic dimension of market co-ordination .....	176
5.6	Forecast error for wind farms in Germany .....	177
5.7	Power spot price formation in a low wind and a high wind scenario .....	182
5.8	The provision of wind balancing services .....	184
6.1	Installation of distribution assets over time .....	193
6.2	Smart grids bring benefits to all actors along the electricity value chain .....	195
6.3	The principle of peak-shaving to avoid high generating costs .....	196
6.4	Cost estimations of different energy storage technologies in use .....	198
6.5	The optimal amounts of nuclear capacity with and without annual load smoothing due to smart grids and virtual power plants .....	201
6.6	Electricity flows after the outage of a generating unit .....	204
6.7	Main areas of the Italian electric system .....	205
7.1	Renewable energies for the different scenarios: a) installed capacities and b) annual electricity generation .....	217
7.2	Comparison of electricity demand load and residual load for a) 50% and b) 80% share of renewable energies .....	220
7.3	Amplitude of changes of a) the demand load and the residual load in the b) 50% and c) 80% scenarios .....	221
7.4	Duration curve of required storage capacity for the 50% and the 80% scenarios .....	222
7.5	Installed power plant and pump storage capacities for considered scenarios with varying shares of renewables and varying installed capacities of nuclear power .....	223

7.6	Annual electricity generation for considered scenarios with varying shares of renewables and varying installed capacities of nuclear power .....	223
7.7	Annual electricity supply costs for considered scenarios with varying shares of renewables and varying installed capacities of nuclear power .....	224
7.8	Duration curves of wholesale electricity prices for scenarios with an installed nuclear power capacity of 20.7 GW (“NUCL-21”) and different renewable shares .....	225
7.9	Duration curves of wholesale electricity prices for scenarios with a 35% renewable share and different installed capacities of nuclear power .....	225
7.10	Annual CO <sub>2</sub> emissions for considered scenarios with varying shares of renewables and varying installed capacities of nuclear power .....	226
7.1A	Scenario grid for the modelling of stochastic wind power generation .....	230
7.1B	Annual electricity generation for scenarios with 80% renewables and varying annual availability of electricity generation from wind and PV power plants .....	233
7.2B	Duration curves for wholesale electricity prices for scenarios with 80% renewables and varying annual availability of electricity generation from wind and PV power plants .....	234

## TABLES

ES.1	The load following ability of dispatchable power plants in comparison .....	16
ES.2	Grid-level system costs in selected OECD countries (USD/MWh) .....	17
ES.3	Electrical load and profitability losses in the short term .....	19
3.1	NPP regulation margins in France .....	68
3.2	The load following ability of dispatchable power plants in comparison .....	79
3.3	Production cost increase due to load following .....	84
3.4	Summary of hourly prices in the EEX day-ahead market .....	86
3.5	The benefits of economic load following as a function of different variable costs .....	87
3.6	Estimation of seasonal management value .....	99
4.1	The system cost matrix .....	105
4.2	The cost increase for a 100 MW offshore wind farm due to the integration of grid connection costs .....	106
4.3	The external costs of electricity in Europe from 2005 to 2010 (EUR/MWh in EU 27) .....	119
4.4	Severe accidents with at least five fatalities from 1970 to 2005 .....	120
4.5	Plant-level costs .....	123
4.6	Grid-level system costs in selected OECD countries .....	127
4.7	Total cost of electricity supply at different penetration levels of renewable energy (USD/MWh) .....	131
4.8	Electrical load and profitability losses in the short term relative to the scenario without renewables .....	136
4.9	Short- and long-term CO <sub>2</sub> emissions .....	141
4.10	CO <sub>2</sub> emissions at different carbon price levels .....	142
4.1A	Country electricity data .....	143

---

4.2A	Technology-by-technology data on electricity generating costs .....	144
4.3A	System cost data .....	146
4.1B	Total cost increase per unit of renewable production above the reference case .....	149
4.2B	Increase in the total cost of electricity supply due to the integration of renewable energy (million USD) .....	150
4.1D	Summary of system cost .....	157
5.1	A detailed overview of renewable energy support instruments in the EU-27 in 2010 .....	180
6.1	Electricity flows after the outage of a generating unit .....	204
6.2	Actual and differential reserves in the Italian scenario .....	205
6.3	Type of options available to the investor .....	207
7.1	Scenarios analysed .....	216
7.2	Shares of fully dispatchable and variable renewables in the annual electricity demand .....	216
7.3	Investment costs of power plants and pump storages .....	216
7.4	Fuel prices for all scenarios (including transportation costs to power plant) .....	216
7.5	Electricity unit supply costs in EUR/MWh for considered scenarios with varying shares of renewables and varying installed capacities of nuclear power .....	224

## Executive summary

### What are system effects?

Electricity generating power plants do not exist in isolation. They interact with each other and their customers through the electricity grid as well as with the wider natural, economic and social environment. This means that electricity production generates costs beyond the perimeter of the individual plant. Such external effects or system effects can take the form of intermittency, network congestion or greater instability but can also affect the quality of the natural environment or pose risks in terms of security of supply. Accounting for such system costs can make significant differences to the social and private investor costs of different power generation technologies.

This study focuses on the system effects of nuclear power and variable renewables, such as wind and solar, as their interaction is becoming increasingly important in the decarbonising electricity systems of OECD countries. In particular, the integration of variable renewables is a complex issue that profoundly affects the structure, financing and operational mode of electricity systems in general and nuclear in particular. The present study, overseen by the Working Party on Nuclear Energy Economics (WPNE) of the OECD Nuclear Energy Agency (NEA), presents an overview of the most important system effects, proposes methodologies to assess them and provides systematic empirical cost estimates.

The introduction of significant amounts of variable renewables generates a number of hitherto unaccounted for impacts that are composed *inter alia* of the increased costs for transport and distribution grids, short-term balancing and long-term adequacy. The deployment of electricity from variable renewables is also significantly affecting the economics of dispatchable power generation technologies, in particular those of nuclear power, both in the short and the long run.

In the short run, with the current structure of the power generation mix remaining in place, all dispatchable technologies, nuclear, coal and gas, will suffer due to lower average electricity prices and reduced load factors. Due to its relatively low variable costs, existing nuclear power plants will do better than gas and coal plants, which are already substantially affected in some countries. In the long run, however, high-fixed cost technologies such as nuclear will be affected disproportionately by the increased difficulties in financing further investments in volatile low-price environments.

The outcome of these competing factors will depend on the amount of variable renewables being introduced, local conditions and the level of carbon prices. The latter are particularly important. While nuclear power has some system costs of its own, it remains the only major dispatchable low-carbon source of electricity, other than hydropower which is in limited supply. Carbon prices will thus be an increasingly important tool to differentiate between low-carbon and high-carbon dispatchable technologies.

All power generation technologies cause system effects. By virtue of being connected to the same physical grid and delivering into the same market, they exert impacts on each other as well as on the total load available to satisfy demand at any given time. The interdependencies are heightened by the fact that only small amounts of cost-efficient electricity storage are available. Variable renewables such as wind and solar, however, generate system effects that are, according to the results of this study, at least an order of magnitude greater than those caused by dispatchable technologies.

System costs in this study are defined as the total costs above plant-level costs to supply electricity at a given load and given level of security of supply. In principle, this definition would include costs external to the electricity market such as environmental costs or impacts on the security of supply. However, this study focuses primarily on the costs that accrue inside the electricity system to producers, consumers and transport system operators. This subset of system costs that are mediated by the electricity grid are referred to in the following as “grid-level system costs” or “grid costs” (see Figure ES.1).

**Figure ES.1: Plant-level, grid-level and total system costs**

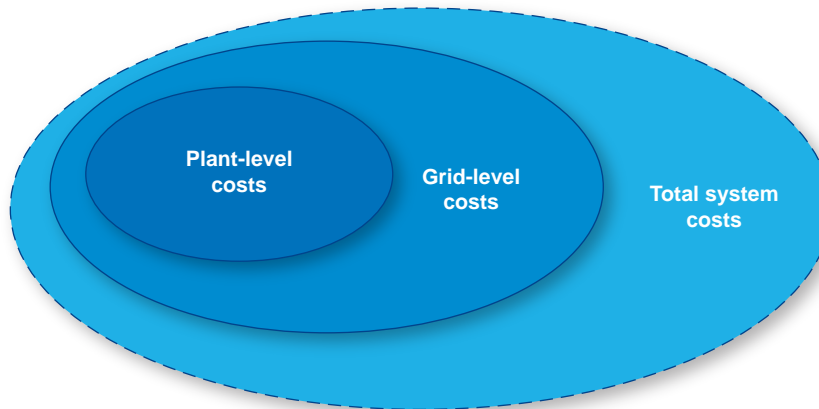

Grid-level system costs already constitute real monetary costs. They are incurred as present or future liabilities by producers, consumers, taxpayers or transport grid operators. Such grid-level system costs can be divided broadly into two categories: (1) the costs for additional investments to extend and reinforce transport and distribution grids as well as to connect new capacity to the grid; and (2) the costs for increased short-term balancing and for maintaining the long-term adequacy of electricity supply in the face of the intermittency of variable renewables.

The study does not neglect “total system costs” but does not attempt to systematically assess them in monetised form. Total system costs would include those effects that are difficult to monetise and that could affect a country’s wider economy and well-being beyond the power sector itself. This broader set of system costs would include environmental externalities other than CO<sub>2</sub> emissions, impacts on the security of energy supply and a country’s strategic position as well as other positive or negative spillover effects relating to technological innovation, economic development, accidents, waste, competitiveness or exports.

This study also examines the pecuniary and dynamic effects of variable renewables. These are difficult to conceptualise clearly, may not constitute externalities in the traditional sense of the term and are difficult to quantify fully at the current stage of debate. However, they may well constitute the impacts that are most acutely felt by electricity producers and may in the long run have the most profound effect on the operations and structure of electricity markets. The three principal effects falling into this category are:

- Lower and more volatile electricity prices in wholesale markets due to the influx of variable renewables with low marginal costs.
- The reduction of the load factors of dispatchable power generators (the compression effect) as low-marginal cost renewables have priority over dispatchable supply.
- The de-optimisation of the current production structure coupled with the influx of renewables implies an increasing wedge between the costs of producing electricity and prices on electricity wholesale markets.



In assessing grid-level costs, total system costs and financial impacts of different power generation technologies, this study clearly recognises that it is participating in an ongoing, sometimes highly technical, discussion that has yet to deliver generally accepted results in an area – the structure of a country’s electricity supply – that has strong advocates for differing viewpoints. Present conclusions and to some extent even methodologies are likely to be refined or further developed in the future.

Nevertheless, the study has the objective to draw attention to the fact that system costs are an increasingly important portion of the total costs of electricity and must be recognised and internalised in order to avoid serious challenges to the security of electricity supply in the coming years. It also provides the first systematic assessment of the grid-level system costs for different technologies in six OECD countries. The study thus advances the discussion on this important issue that is likely to shape the future of the electricity supply in OECD countries and, in particular, that of nuclear energy over the coming years.

## Nuclear power and system effects

This report addresses the system effects of power generation technologies in general, while focusing on the effects stemming from variable renewables and nuclear energy. It also considers the ability of nuclear energy to contribute to the internalisation of the system costs generated by intermittency in low-carbon electricity systems.

The most important system effects of nuclear power relate to its specific siting requirements, the conditions that it poses for the outlay and technical characteristics of the surrounding grid, as well as specific balancing requirements due to the size of nuclear power plants. Siting constraints may also affect the overall economics of the nuclear power plant, via a longer time for site selection, additional investment costs for upgrades or reduced overall efficiency of the plant. However, those costs are mainly borne by the nuclear power plant developer and only impose limited additional costs on the electricity system as a whole. The specific arrangements in place in OECD countries may be different with regard to the special conditions that nuclear power plants impose on the electrical system in terms of higher requirements for grid stability and security, specific conditions for the grid layout, as well as the interaction between the overall generation system and nuclear plants due to the latter’s operational characteristics.

Nuclear power may cause additional balancing costs if the transport system operators have to maintain a larger amount of spinning reserves to ensure the stability and reliability of the electricity supply. In fact, the large size of a nuclear power plant may require increasing the amount of available reserves to offset, according to the N-1 criterion, the risk of a frequency drop in the case that a nuclear power plant trips. All these system costs are real, but are overall in the range of USD 2-3 per MWh, slightly above those of other dispatchable technologies but well below those of variable renewables (see Table ES.2 below).

At least as important as the system effects of nuclear power plants themselves is their ability to deal with the system effects generated by other technologies, in particular variable renewables. The short-term intermittency of wind and solar plants puts great demands on the dispatchable providers of residual demand to vary substantial portions of their load in very short time frames. The ability to follow load will become an increasingly important criterion to choose between different back-up technologies. In this context, only nuclear and hydro do not emit any greenhouse gases during electricity generation.

Most nuclear power plants operate at stable levels close to full capacity in order to supply baseload electricity. This is not only the simplest operational mode but also economically the most advantageous as long as prices are stable, and it is thus the operational mode that is preferred in most OECD countries. For different reasons, there exists considerable experience with load following by nuclear power plants in France and Germany. In France, nuclear capacity exceeds baseload needs during certain periods during which it is necessary to reduce nuclear load. In Germany, the introduction of large amounts of variable renewables has repeatedly led to prices below the marginal costs of nuclear, including several instances of negative prices.

Based on the French and the German experiences, nuclear power has the technical capabilities to engage in load following. While more precise results would depend on the specific reactor technologies employed, the results below were reported for currently operating reactors in France and Germany. They are also consistent with the current European Utility Requirements (EUR). The short-term load following capabilities of nuclear power plants are thus comparable to those of coal-fired power plants but somewhat below plants with combined cycle gas turbines (CCGT). They clearly remain inferior to those of open cycle gas turbines (OCGT); however, the latter's very high variable costs limit their use except for covering the most extreme demand peaks (see Table ES.1). During load following, different technologies must also operate in certain ranges of total capacity, in particular nuclear power. While new nuclear power plants can operate at a power level as low as 25% of their rated capacity, most of the older designs cannot be operated for a prolonged period below 50% of their rated capacity.

**Table ES.1: The load following ability of dispatchable power plants in comparison**

	Start-up time	Maximal change in 30 sec	Maximum ramp rate (%/min)
Open cycle gas turbine (OCGT)	10-20 min	20-30%	20%/min
Combined cycle gas turbine (CCGT)	30-60 min	10-20%	5-10%/min
Coal plant	1-10 hours	5-10%	1-5%/min
Nuclear power plant	2 hours - 2 days	up to 5%	1-5%/min

Source: EC JRC, 2010 and NEA, 2011.

The study also provides estimates of the economic value generated by load following, which depends on the volatility of electricity prices, marginal costs and the minimum load requirements of a plant. While the benefits to the nuclear utility of around USD 1 per MWh or less are quite limited, the contribution to the stabilisation of overall dispatchable load and prices is certainly higher, but impossible to assess in the context of the current study.

Residual demand can be further stabilised through seasonal nuclear fleet management, as exemplified in France. Fleet management thus reduces the potential imbalances introduced by the regular outages for refuelling and maintenance by 6.4 GW which corresponds to a benefit that lies, depending on assumptions, around USD 1 per MWh or slightly below. While such considerations would primarily apply to countries with a large share of nuclear in the generation mix, the total gains at the level of the electricity system can be significant.

## Measuring system effects

The central contribution of this study is the detailed qualitative assessment of total system costs and the explicit quantitative assessment of grid-level system costs. As previously noted, the assessment of total system costs should include not only the costs for grid connection, extension and reinforcement, the technical and financial costs of intermittency but also security of supply impacts, local and global environmental impacts, siting and safety (both in its objective and subjective dimensions). The comparative performance of nuclear power in most dimensions is quite good. A thorough comparison of environmental impacts, both local and global, in the recent NEEDS project,<sup>1</sup> as well as a comparison of the impacts of major accidents on the basis of data from the Paul Scherrer Institute and the World Health Organisation (WHO), both show that the performance of nuclear power in these crucial dimensions of public attention is better than that of its competitors, but still remains a sensitive issue.

1. Recently, the web-based NEEDS project, which stands for New Energy Externalities Development for Sustainability and is sponsored by the European Commission, has established life-cycle inventories for different scenarios of future electricity supply ([www.needs-project.org](http://www.needs-project.org)) and has updated many previous externality estimates.

The most innovative contribution of the study, however, is certainly the systematic quantitative assessment of grid-level system costs in a number of selected OECD countries. On the basis of a common methodology and a large number of country-specific studies for the underlying data, the costs for short-term balancing<sup>2</sup> and long-term adequacy,<sup>3</sup> as well as the costs for grid connection, extension and reinforcement required for different technologies were calculated for Finland, France, Germany, the Republic of Korea, the United Kingdom and the United States. Technologies included were nuclear, coal, gas, onshore wind, offshore wind and solar PV. System costs were calculated at 10% and 30% penetration levels of the main generating sources.

The results show that system costs for the dispatchable technologies are relatively modest and usually below USD 3 per MWh. They are considerably higher for variable technologies and can reach up to USD 40 per MWh for onshore wind, up to USD 45 per MWh for offshore wind and up to USD 80 per MWh for solar, with the high costs for adequacy and grid connection weighing heaviest. The costs for variable renewables would be lower by roughly USD 10 to USD 20 (USD 26 in the case of UK solar) per MWh if the costs for back-up were not included, under the assumption that current electricity systems of OECD countries already have sufficient dispatchable capacity to cover demand at all times. While this may be an admissible assumption in the short run, it would not be a correct assumption for the long run when existing capacity needs to be replaced.<sup>4</sup>

**Table ES.2: Grid-level system costs in selected OECD countries (USD/MWh)**

Finland												
Technology	Nuclear		Coal		Gas		Onshore wind		Offshore wind		Solar	
	10%	30%	10%	30%	10%	30%	10%	30%	10%	30%	10%	30%
Penetration level												
Back-up costs (adequacy)	0.00	0.00	0.06	0.06	0.00	0.00	8.05	9.70	9.68	10.67	21.40	22.04
Balancing costs	0.47	0.30	0.00	0.00	0.00	0.00	2.70	5.30	2.70	5.30	2.70	5.30
Grid connection	1.90	1.90	1.04	1.04	0.56	0.56	6.84	6.84	18.86	18.86	22.02	22.02
Grid reinforcement and extension	0.00	0.00	0.00	0.00	0.00	0.00	0.20	1.72	0.12	1.04	0.56	4.87
<b>Total grid-level system costs</b>	<b>2.37</b>	<b>2.20</b>	<b>1.10</b>	<b>1.10</b>	<b>0.56</b>	<b>0.56</b>	<b>17.79</b>	<b>23.56</b>	<b>31.36</b>	<b>35.87</b>	<b>46.67</b>	<b>54.22</b>

France												
Technology	Nuclear		Coal		Gas		Onshore wind		Offshore wind		Solar	
	10%	30%	10%	30%	10%	30%	10%	30%	10%	30%	10%	30%
Penetration level												
Back-up costs (adequacy)	0.00	0.00	0.08	0.08	0.00	0.00	8.14	8.67	8.14	8.67	19.40	19.81
Balancing costs	0.28	0.27	0.00	0.00	0.00	0.00	1.90	5.01	1.90	5.01	1.90	5.01
Grid connection	1.78	1.78	0.93	0.93	0.54	0.54	6.93	6.93	18.64	18.64	15.97	15.97
Grid reinforcement and extension	0.00	0.00	0.00	0.00	0.00	0.00	3.50	3.50	2.15	2.15	5.77	5.77
<b>Total grid-level system costs</b>	<b>2.07</b>	<b>2.05</b>	<b>1.01</b>	<b>1.01</b>	<b>0.54</b>	<b>0.54</b>	<b>20.47</b>	<b>24.10</b>	<b>30.83</b>	<b>34.47</b>	<b>43.03</b>	<b>46.55</b>

2. Balancing refers to the ability to maintain the required system performance on a minute-by-minute basis, in the presence of uncertainty in supply and demand.

3. Adequacy refers to the ability of the system to satisfy demand at all times, taking into account the fluctuations in supply and demand, reasonably expected outages of system components, the projected retirement of generating facilities, and so forth.

4. The costs of dispatchable back-up for variable renewables are due only in the case that assumes that variable renewables are installed to cover genuinely new demand. In the case that the working assumption is that variable renewables are introduced into systems with dispatchable capacity that is already fully capable of satisfying demand at all times, the back-up costs can be dispensed with and thus the system costs will be lower. The study also presents an alternative methodology to calculate the costs of providing back-up capacity.

Germany												
Technology	Nuclear		Coal		Gas		Onshore wind		Offshore wind		Solar	
	10%	30%	10%	30%	10%	30%	10%	30%	10%	30%	10%	30%
Penetration level												
Back-up costs (adequacy)	0.00	0.00	0.04	0.04	0.00	0.00	7.96	8.84	7.96	8.84	19.22	19.71
Balancing costs	0.52	0.35	0.00	0.00	0.00	0.00	3.30	6.41	3.30	6.41	3.30	6.41
Grid connection	1.90	1.90	0.93	0.93	0.54	0.54	6.37	6.37	15.71	15.71	9.44	9.44
Grid reinforcement and extension	0.00	0.00	0.00	0.00	0.00	0.00	1.73	22.23	0.92	11.89	3.69	47.40
<b>Total grid-level system costs</b>	<b>2.42</b>	<b>2.25</b>	<b>0.97</b>	<b>0.97</b>	<b>0.54</b>	<b>0.54</b>	<b>19.36</b>	<b>43.85</b>	<b>27.90</b>	<b>42.85</b>	<b>35.64</b>	<b>82.95</b>

Republic of Korea												
Technology	Nuclear		Coal		Gas		Onshore wind		Offshore wind		Solar	
	10%	30%	10%	30%	10%	30%	10%	30%	10%	30%	10%	30%
Penetration level												
Back-up costs (adequacy)	0.00	0.00	0.03	0.03	0.00	0.00	2.36	4.04	2.36	4.04	9.21	9.40
Balancing costs	0.88	0.53	0.00	0.00	0.00	0.00	7.63	14.15	7.63	14.15	7.63	14.15
Grid connection	0.87	0.87	0.44	0.44	0.34	0.34	6.84	6.84	23.85	23.85	9.24	9.24
Grid reinforcement and extension	0.00	0.00	0.00	0.00	0.00	0.00	2.81	2.81	2.15	2.15	5.33	5.33
<b>Total grid-level system costs</b>	<b>1.74</b>	<b>1.40</b>	<b>0.46</b>	<b>0.46</b>	<b>0.34</b>	<b>0.34</b>	<b>19.64</b>	<b>27.84</b>	<b>35.99</b>	<b>44.19</b>	<b>31.42</b>	<b>38.12</b>

United Kingdom												
Technology	Nuclear		Coal		Gas		Onshore wind		Offshore wind		Solar	
	10%	30%	10%	30%	10%	30%	10%	30%	10%	30%	10%	30%
Penetration level												
Back-up costs (adequacy)	0.00	0.00	0.06	0.06	0.00	0.00	4.05	6.92	4.05	6.92	26.08	26.82
Balancing costs	0.88	0.53	0.00	0.00	0.00	0.00	7.63	14.15	7.63	14.15	7.63	14.15
Grid connection	2.23	2.23	1.27	1.27	0.56	0.56	3.96	3.96	19.81	19.81	15.55	15.55
Grid reinforcement and extension	0.00	0.00	0.00	0.00	0.00	0.00	2.95	5.20	2.57	4.52	8.62	15.18
<b>Total grid-level system costs</b>	<b>3.10</b>	<b>2.76</b>	<b>1.34</b>	<b>1.34</b>	<b>0.56</b>	<b>0.56</b>	<b>18.60</b>	<b>30.23</b>	<b>34.05</b>	<b>45.39</b>	<b>57.89</b>	<b>71.71</b>

United States												
Technology	Nuclear		Coal		Gas		Onshore wind		Offshore wind		Solar	
	10%	30%	10%	30%	10%	30%	10%	30%	10%	30%	10%	30%
Penetration level												
Back-up costs (adequacy)	0.00	0.00	0.04	0.04	0.00	0.00	5.61	6.14	2.10	6.85	0.00	10.45
Balancing costs	0.16	0.10	0.00	0.00	0.00	0.00	2.00	5.00	2.00	5.00	2.00	5.00
Grid connection	1.56	1.56	1.03	1.03	0.51	0.51	6.50	6.50	15.24	15.24	10.05	10.05
Grid reinforcement and extension	0.00	0.00	0.00	0.00	0.00	0.00	2.20	2.20	1.18	1.18	2.77	2.77
<b>Total grid-level system costs</b>	<b>1.72</b>	<b>1.67</b>	<b>1.07</b>	<b>1.07</b>	<b>0.51</b>	<b>0.51</b>	<b>16.30</b>	<b>19.84</b>	<b>20.51</b>	<b>28.26</b>	<b>14.82</b>	<b>28.27</b>

Establishing estimates for grid-level system costs also allows calculation of the total costs of electricity supply with and without variable renewables. Introducing variable renewables up to 10% of the total electricity supply will increase per MWh cost, depending on the country, between 5% and 50%, whereas satisfying 30% of demand might increase per MWh costs by anything between 16% and 180% (the latter relating to solar in Finland).

While the range of values for different countries and technologies is very large indeed, even in the most favourable cases system costs are too large to be ignored. While onshore wind is usually the variable technology with the lowest grid-level system costs and solar PV the one with the highest, country-by-country differences are more important than technology-by-technology differences. This means that

natural endowments and circumstances matter enormously. It may also explain to some extent differing public and policy attitudes towards the large-scale deployment of variable renewables in different countries.

Finally, the study attempts to analyse the impacts of the deployment of variable renewables on the load factors and profitability of dispatchable technologies in the short run and on their optimal capacities in the long run. Table ES.3 below provides a first indication of the losses in load factors and profitability. It shows that those most heavily affected in the short run are indeed the technologies with the highest variable costs, which are hit hard by the unavoidable decline in electricity prices due to the influx of 10% or 30% of electricity with zero marginal cost.

**Table ES.3: Electrical load and profitability losses in the short term<sup>5</sup>**

Penetration level		10%		30%	
Technology		Wind	Solar	Wind	Solar
Load losses	Gas turbine (OCGT)	-54%	-40%	-87%	-51%
	Gas turbine (CCGT)	-34%	-26%	-71%	-43%
	Coal	-27%	-28%	-62%	-44%
	Nuclear	-4%	-5%	-20%	-23%
Profitability losses	Gas turbine (OCGT)	-54%	-40%	-87%	-51%
	Gas turbine (CCGT)	-42%	-31%	-79%	-46%
	Coal	-35%	-30%	-69%	-46%
	Nuclear	-24%	-23%	-55%	-39%
Electricity price variation		-14%	-13%	-33%	-23%

In the long run, the situation changes as high fixed cost technologies will leave the market due to reduced numbers of full load hours. While average electricity prices will tend to remain stable as low variable cost baseload providers leave the market, their volatility will increase strongly.

A country study of Germany based on the large, integrated energy market model of the IER Institute of the University of Stuttgart confirms at least the orders of magnitudes of the results derived in this study. This is encouraging as the two methodologies employed are entirely different.

Both the calculations in Chapter 4 of this study and the IER modelling effort, whose key results are reproduced in Chapter 7, show that the large increases in electricity supply costs as the share of variable renewables rises result from a combination of higher investment costs, balancing and adequacy costs as well as additional expenses for transmission and distribution. Both calculations also show a rapid decline in wholesale electricity prices as a function of the increasing share of low marginal cost renewables. Electricity systems with very high renewable shares will have electricity prices equal to or below zero during a high number of hours of a year. This remains a major challenge for dispatchable technologies which, unlike renewables, do not receive any subsidies.

### Internalising system effects through capacity mechanisms and technological change

The introduction of large amounts of variable renewables creates, in many ways, a radically new situation in electricity wholesale markets, which will require rapid adaptation from all actors. Currently, dispatchable producers ensuring the public good of security of electricity supply are exposed to increasing commercial pressures due to the lower wholesale electricity prices and reduced load factors resulting from the influx of large amounts of electricity from subsidised renewables. This requires the creation of

5. The data presented in this table have been obtained for an optimal (least-cost) dispatchable generation mix, comprising nuclear, coal and gas. Electricity price is assumed to be the cost of the marginal technology plus a mark-up of USD 10 per MWh.

new and innovative institutional, regulatory and financial frameworks that would allow the emergence of markets that remunerate so-called “flexibility services”, which includes the provision of short-term balancing services and, in particular, sufficient amounts of dispatchable long-term capacity.

It also requires rethinking the mechanisms through which subsidies are administered. While member countries are free to choose the energy mix they prefer, the combination of fixed feed-in tariffs (FITs) and grid priority for renewables, means that the latter have no incentive to adjust their load to overall market conditions. Utilities already make an increasing share of their profits in the balancing and adjustment markets for primary, secondary and tertiary reserves to adjust load to the variable production of renewables. While this may alleviate short-term commercial pressures, it is an inefficient manner in which to run an electricity system, creating additional costs that ultimately have to be absorbed by consumers through higher tariffs for transport and distribution. More efficient mechanisms would be feed-in premiums (FIPs) or an obligation for all providers, including producers based on variable renewables, to feed stable hourly bands into the system, even if this means subsequently remunerating the latter for the added costs.

**Figure ES.2: Annual electricity supply costs in Germany as a function of different shares of variable renewables and nuclear**

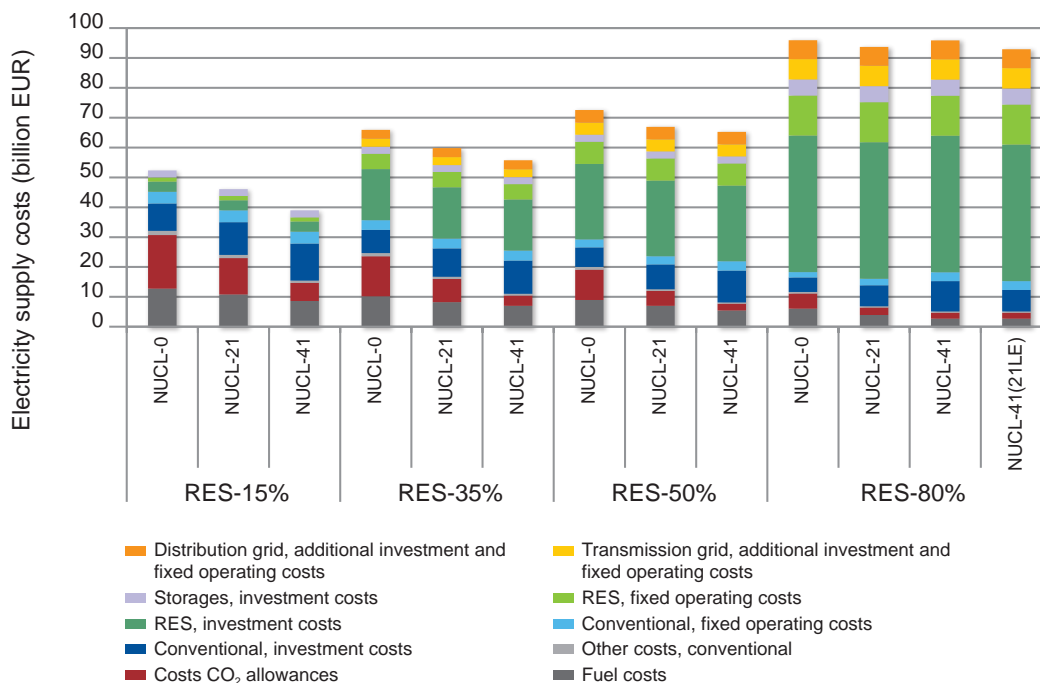

Note: The acronyms on the horizontal axis correspond to scenarios without nuclear (NUCL-0) and with installed nuclear capacity of 21 GW (NUCL-21) and 41 GW (NUCL-41); RES indicates the share of renewable energy sources in electricity production.

On the supply side for flexibility services, the study shows that there are essentially four dimensions in which one may consider providing the necessary balancing and capacity services to ensure the balance between demand and supply in electricity systems with a significant share of variable renewables:

- Short-term spinning reserves and long-term capacity provided by dispatchable power generators such as nuclear, coal or gas.
- The extension of existing market interconnections to spread demand and supply imbalances over larger areas.

- Storage in order to have short-term power reserves available in time of need.
- Demand-side management (DSM) to curb demand in case of supply shortfalls.

Given the current market environment, a particular role in this context could be played by capacity mechanisms to remunerate dispatchable capacity purely for its availability in time of need. The technical and pecuniary system effects of variable renewables are already putting considerable stress on the long-term adequacy of the electricity systems of OECD countries. The clear implication is that dispatchable technologies, including nuclear, will require that a portion of their revenues be derived from other sources if they are to stay in the market and provide the necessary back-up services. There are currently three major perspectives in which such additional revenue generation can be envisaged:

- Capacity payments or markets with capacity obligations, in which variable producers need to acquire the adequacy services from dispatchable providers, which would thus earn additional revenue.
- Long-term, fixed-price contracts subscribed by governments for guaranteed portions of the output of dispatchable plants whether in the form of contracts for differences or feed-in tariffs.
- The gradual phase-out of subsidies to variable renewables and the discontinuation of grid priority and a “shallow” allocation of additional grid costs; this would slow down the latter’s deployment, which is currently bought at considerable economic cost, but would also force the internalisation of grid and balancing costs.

Governments and regulators in OECD countries will need to swiftly start the necessary processes of education, consultation and consistent policy formulation that will allow for such additional mechanisms. This is not an easy task. Given that all such mechanisms will inevitably increase electricity prices but will also be seen as support for technologies such as nuclear, coal or gas that may raise safety, environmental or security of supply concerns, such necessary reforms will not be easy unless their underlying rationale, the protection of electricity supply security, which is a highly valued good in its own right, is convincingly explained and communicated. The alternative, repeated challenges to and occasional breakdowns of electricity supply, is far worse.

The need for structural change in electricity markets will also drive technological change. Therefore, the study discusses two technologies that have potential transformative power for the way electricity is produced and consumed – smart grids and small modular reactors. “Smart” or “intelligent” electricity grids have recently received a high degree of attention due to progress in information technology, heightened regulatory focus and better informed consumers as well as an increasing need for flexibility due to the arrival of significant amounts of variable renewables. In parallel, a number of improvements have taken place in network infrastructure, operations and regulation, which together are likely to have a significant impact on the operation of the different parts of the electricity system (generation, trading, transmission and consumption).

With respect to nuclear energy, a pervasive deployment of smart electricity grids might lead to two very different outcomes. On the one hand, smart grids favour nuclear energy by smoothing load curves and providing added opportunities for large baseload providers such as nuclear. As the latter are faced with the risk that a high share of variable renewables such as wind and solar reduces the number of hours during which a given demand is guaranteed (compression effect), the role of smart grids in this case is to reshape the residual demand curve. Through demand response, load shifting and integration of storage applications, smart grids might change the load curve and re-establish a stable, continuous demand for longer periods of time. This way, a minimum demand over a sufficiently high number of hours could be achieved, resulting in a role for nuclear baseload even in systems with a strong penetration of renewable energy sources.

On the other hand, smart grids may enable decentralised production from smaller units where demand-supply balancing is performed on a more local scale and thus restrict the demand for large baseload units such as nuclear. A more decentralised electricity system based on local energy sources could under certain conditions, such as the local matching of supply and demand, allow for shorter electricity transport distances and thus reduce electricity transmission losses. In such a setting, nuclear power plants could only be used in economically less attractive load following modes as part of so-called local virtual power plants (VPP). This is clearly an issue to be followed closely in the years to come.

As far as nuclear technology is concerned, the deployment of small modular reactors (SMRs) may offer greater flexibility to investors and reduce the balancing costs by reducing the size of the reactor. Their smaller size eases their siting and integration into the electrical grid and guarantees stronger operational flexibility, thus reducing the system costs. From an economic viewpoint, SMRs currently still have higher per unit investment costs and, consequently, higher levelised costs of electricity (LCOE) than larger nuclear units.

However, the smaller size of SMRs offers a broader range of opportunities for choosing the generating portfolio and provides higher flexibility in making investment decisions. The shorter construction time and the possibility of fractioning the total investment in several subsequent units allows utilities to defer or suspend a nuclear project if market conditions are unfavourable. This reduces the overall financial risk. Such investment flexibility is particularly valuable in deregulated electricity markets with variable renewables, where electricity market prices are particularly volatile.

## Policy recommendations

System costs in electricity markets are a major issue. While all technologies have system costs, those generated by variable renewables are of at least an order of magnitude larger than those of dispatchable technologies. In addition, they are creating a market environment in which dispatchable technologies are no longer able to finance themselves through revenues in “energy only” electricity wholesale markets. In addition, system costs tend to increase over-proportionally with the amount of variable electricity injected into the system. This has serious implications for the security of electricity supplies. It is only due to the weakened demand for electricity in the current low-growth environment of OECD economies and the considerable excess capacity constructed during more favourable periods in the past that more serious stresses have so far been avoided.

The magnitude of both technical and pecuniary system costs implies that they can no longer be borne in a diffuse and unacknowledged manner by operators of dispatchable technologies as an unspecified system service. Currently, dispatchable technologies are expected to provide the back-up for intermittent renewables to cover demand when the latter are unavailable. This service is costly, but currently not remunerated. Economically speaking, dispatchable technologies are expected to provide the unremunerated positive externality of long-term flexible capacity for back-up. System costs require (a) fair and transparent allocation mechanisms to maintain economically sustainable electricity markets and (b) new regulatory frameworks to ensure that balancing and long-term capacity provision can be provided at least cost.

While future studies will undoubtedly refine the results of this study, in particular with respect to the empirical estimates, current research already allows the identification of four main policy recommendations:

### Recommendation 1

*It is important to ensure the transparency of power generation costs at the system level:* when making policy decisions affecting their electricity markets, OECD countries need to consider the full system costs of different technologies. Failure to do so will rebound in terms of unanticipated cost increases in overall power supply for many years to come.

### Recommendation 2

*Regulatory frameworks to minimise system costs and favour their internalisation should be prepared:* OECD countries with major shares of intermittent renewables need to plan and implement coherent strategies for the long-term adequacy of their energy systems. Four points have particular importance for rendering future electricity market frameworks sustainable:

- The decrease in revenues for the operators of dispatchable capacity due to the compression effect needs to be recognised and adequately compensated through capacity payments or markets with capacity obligations.



- To internalise the system costs for balancing and adequacy effectively, one option may be to feed stable hourly bands of electricity into the grid rather than random amounts of intermittent electricity. If the introduction of variable renewables remains the overriding policy objective, additional non-proportional compensation can be offered.
- While costs for grid reinforcement and interconnection are difficult to allocate to any one technology, the costs for grid extension and connection should be allocated as far as possible to the respective operators.
- The implications for carbon emissions of different strategies for back-up provision need to be closely monitored and should be internalised through a robust carbon tax.

### **Recommendation 3**

*The value of dispatchable low-carbon technologies in complementing the introduction of variable renewables should be more effectively recognised.* Nuclear energy, as a low-carbon provider of flexible back-up capacity in systems with significant shares of intermittent renewables, plays an important role in meeting policy goals and should be recognised. A combination of capacity markets, long-term supply contracts and carbon taxes would provide a market-based framework to ensure that nuclear energy and other dispatchable low-carbon technologies remain economically sustainable.

### **Recommendation 4**

*Flexibility resources for future low-carbon systems must be developed.* At the current stage of technological development, low-carbon electricity systems will inevitably be based on high shares of variable renewables and nuclear energy. Hence it is recommended that flexibility resources should be developed based on a systems approach where full costs and interdependencies are recognised. This will require increasing the load-following abilities of dispatchable low-carbon back-up including nuclear, expanding storage, rendering demand more responsive and increasing international interconnections.

## References

- EC JRC (2010), *Load-following Operating Mode at Nuclear Power Plants (NPPs) and Incidence on Operation and Maintenance (O&M) Costs. Compatibility with Wind Power Variability*, C. Bruynooghe, A. Eriksson, G. Fulli, European Commission, JRC Scientific and Technical Reports, Brussels, Belgium.
- NEA (2011), *Technical and Economic Aspects of Load Following with Nuclear Power Plants*, Nuclear Energy Agency, OECD, Paris, France. Available at [www.oecd-nea.org/ndd/reports/2011/load-following-npp.pdf](http://www.oecd-nea.org/ndd/reports/2011/load-following-npp.pdf).

## Chapter 1

# Introduction: system effects between nuclear energy and variable renewables

### 1.1 Why a study on the system effects of nuclear energy and variable renewables?

Electricity generating power plants, whether based on nuclear energy, fossil fuels or renewable sources, do not exist in isolation. They interact with each other and their customers through the electricity grid as well as with the wider natural, economic and social environment. This means that electricity production generates costs beyond the perimeter of the individual plant. Such external effects or system effects can affect the quality of the natural environment, can pose risks in terms of the security of supply or, in the case of grid-based electricity systems, can take the form of intermittency, network congestion or greater instability. Accounting for such external effects can make significant differences to the social and private costs of different power generation technologies.

The decision to focus on the interaction of nuclear power and variable renewables results from the rapidly increasing importance of their relationship in the decarbonising electricity systems of OECD countries. All OECD countries currently strive to reduce their greenhouse gas emissions. Due to their stationary nature and limited exposure to international competition, electricity sectors are frequently called upon to generate a major share of these emissions reductions. Beyond reductions in absolute consumption, this means substituting fossil-fuel based power generation with low-carbon technologies such as renewables or nuclear power. For instance, the *Energy Roadmap* of the European Commission (EC) envisions greenhouse gas emissions in 2050 to be at least 80% lower than in 1990, while the electricity sector is supposed to be carbon-neutral by that date (EC, 2011a). Considering that in 2009 nuclear energy generated 28% of European electricity and renewables 18%, of which 10% stemmed from hydropower, one gets a measure of the challenge ahead. While ambitions to reduce greenhouse gas emissions may be more modest, the changes awaiting OECD countries in the Asia-Pacific region or in the Americas, although starting from a lower base are at least as important.

The challenges ahead should not conceal the fact that low-carbon power generation systems already exist in several OECD countries and are working well. While CO<sub>2</sub> emissions from electricity and heat generation in the OECD were 420 kgCO<sub>2</sub> per MWh on average in 2009, countries such as Austria (163 kgCO<sub>2</sub> per MWh), Canada (167 kgCO<sub>2</sub> per MWh) or France (90 kgCO<sub>2</sub> per MWh) have been doing substantially better due to a combination of favourable natural endowments and low-carbon policy choices structured principally around hydropower or nuclear energy (IEA, 2011d, II.67).

In order to increase the share of renewable generation, most of it variable wind and solar generation, OECD governments are promoting their use, frequently through fixed feed-in tariffs (FITs). These policies can lead to substantial changes in the structure of generating capacity. In 2009, according to the International Energy Agency (IEA), variable power sources such as wind and solar already constituted 27% of total generating capacity in Denmark, 26% in Germany and 24% in Spain (IEA, 2011a; 2011b). These shares have already increased in the past two years and may grow further in the years to come.

In future low-carbon electricity systems, nuclear energy will coexist with evermore significant amounts of renewable energies. Given that hydropower is already largely exploited in many OECD countries, the most important reservoir of renewable energy is constituted by wind and solar power, which are characterised by intermittent production due to irregular and uncertain weather patterns. Such variable renewables generate significant costs over and above plant-level production costs at the level of the electricity system. Most studies on the costs of electricity, including the IEA/NEA series on the *Projected*

*Costs of Generating Electricity*, nevertheless concentrate on the level of the production plant. “Grid parity”, the equalisation of plant-level costs with those of conventional technologies, is a frequently evoked target for renewable technologies, many of which still require subsidies to compete even on plant-level costs. Concentrating on the latter corresponds to intuition, standard economic theory and established accounting procedures. Limiting cost accounting to the individual plant is also acceptable for broader policy analysis as long as the system costs are small and are in the same order of magnitude for the various generation options, in which case, they can be considered as general transaction costs.

Ambitions to base future electricity production primarily or even exclusively on low-carbon<sup>1</sup> power sources, including substantial shares of variable renewables, however, imply that system costs are becoming a significant portion of the total costs of producing electricity and can no longer be neglected in economic analysis and policy-making. The NEA Working Party on Nuclear Energy Economics therefore decided to initiate a project on the System Effects of Electricity System and Nuclear Power as part of the 2011-12 Programme of Work of the Nuclear Development Committee and has overseen the present study.

System costs are a newly arising issue where conceptual clarification and quantitative estimation are still ongoing. Nevertheless, they are increasingly capturing the attention of electricity industry experts and decision-makers. Contrary to the plant-level costs of electricity that are regularly assessed, there still exists only limited knowledge about the nature and magnitude of system costs, although their impacts are being felt in the increasing fragility and rising overall costs of electricity supply in OECD. A key contribution of this study is thus the first ever provision of quantitative estimates of the system costs of different power technologies in the context of different national power systems according to a transparent and replicable methodology. Its objective is to contribute to an open and transparent discussion about the private and social costs of different technology solutions in order to allow for better informed policy choices in OECD countries.

## 1.2 The nature of this study

All power generation technologies cause system costs. By virtue of being connected to the same physical grid and delivering into the same market, they exert impacts on each other as well as on the total load available to satisfy demand at any given time. The interdependencies are heightened by the fact that only small amounts of cost-efficient storage are available, which means that any buffers for supply and demand co-ordination are insufficient. Variable renewables such as wind and solar, however, generate system effects that are, according to the calculations of this study, at least an order of magnitude greater than those caused by dispatchable technologies.

Dispatchable power technologies are those that can provide scalable amounts of electricity to the market at precisely the time when it is needed to cover demand independently, for instance, of meteorological conditions. Gas- and coal-fired plants are dispatchable, as are nuclear power plants (NPP). There also exist dispatchable renewable technologies such as hydropower, biomass, geothermal power or, to some extent, concentrated solar power (CSP). The latter, however, usually have higher costs and are either in limited supply (hydropower), have other inconvenient side-effects (biomass) or can store energy only for a limited period of time (CSP).

The quality of being dispatchable is never absolute. A technical failure, a natural catastrophe or human error can always interrupt supply also from conventional sources. Nevertheless, the ability to manage fleets of dispatchable plants provides a given level of output or corresponding spare capacity with near-certainty, as long as the risks of outage associated with any individual plant remain uncorrelated. Variable renewables usually lack the latter quality, as weather patterns tend to be similar over rather large regions, especially if regional interconnections are limited.

1. All power generating technologies produce some carbon missions if the whole lifecycle is considered. However, direct and indirect carbon emissions from nuclear and renewable technologies are at least one order of magnitude lower than those of fossil-fuelled technologies. A more detailed comparison of carbon emissions from various generating technologies is provided in Chapter 4.

This study deals with the system effects of power generation technologies in general, while focusing on the effects stemming from variable renewables and nuclear energy in particular. It also considers the ability of nuclear energy to contribute to the internalisation of the system costs generated by intermittency in low-carbon electricity systems. *System costs in this study are defined as the total costs above plant-level costs to supply electricity at a given load and given level of security of supply.* In principle, this definition could include costs external to the electricity market such as environmental costs or security of supply impacts. This study, however, focuses primarily on the costs accruing *inside* the electricity system to producers, consumers as well as transport and distribution system operators. A large subset of these costs are the monetisable system costs that are mediated by the electricity grid and are referred to in the following as “grid-level system costs” or “grid costs”.

System costs at the grid-level are real financial costs beyond plant-level costs that are paid for, depending on the allocation rules, by other producers, customers or taxpayers above the explicit subsidies administered through feed-in tariffs for renewable energy. As such system costs are of a different nature than, for instance, environmental externalities that also create real impacts on well-being, but do not immediately result in financial costs for the affected parties. In order to make meaningful cost comparisons between different power generation technologies, their grid-level system costs would need to be taken into account. The present study thus complements and completes the IEA/NEA study on the levelised costs of electricity (LCOE) at the plant level, *Projected Costs of Generating Electricity: 2010 Edition*.

While calculations of LCOE at the plant-level remain a useful and intuitive first guide, they are an increasingly poor guide for decision-making. A summary of written evidence before the Energy and Climate Change Committee of the UK Parliament on the economics of wind power in July 2012 shows an increasing awareness of a need for a system approach to cost accounting also at the level of decision- and policy-makers. Donald Miller, former chairman of Scottish Power thus cites a recent study by the Institution of Engineers and Shipbuilders in Scotland (IESIS) that calculates the added costs of wind power, beyond plant-level LCOE, at the system level at GBP 47/MWh (EUR 60/MWh), which is in the same order of magnitude as the estimations this study provides in Chapter 4 (UK Parliament Energy and Climate Change Committee, 2012; and Gibson, 2011).

The monetary costs at the level of the electricity grid are composed of additional costs for transport and distribution infrastructure on the one hand and of the costs for back-up and balancing on the other. Concerning the costs for added infrastructure, solar and, in particular, wind-power generation have to be located as a function of supply rather than demand. In the case of solar power, the decentralisation of power sources, for instance through rooftop installations, will also require substantial investments in the distribution network. In the case of wind power, the distance of production sites from the centres of consumption requires large investments in electrical transmission.

The costs for back-up are due primarily to intermittency which requires dispatchable capacity for providing back-up electricity to satisfy demand second by second. While the diversification of renewable supply, interconnections with adjacent regions, storage and demand management can all play helpful roles in mitigating intermittency, the most cost-efficient solution at least in the medium-term is likely to remain the use of dispatchable capacity for electricity generation.

The uncertainty of electricity production from wind and solar installations thus requires balancing in the form of costly “spinning reserves”, i.e. dispatchable plants which run at less than full capacity to be able to ramp up production quickly when meteorological conditions change unexpectedly. There exist also additional systemic impacts on electricity systems stemming from the introduction of renewables such as the declining of electricity prices, the reduction of load factors for established plants and the de-optimisation of existing production structures. While important in their own right, these dynamic effects have been treated in a qualitative rather than a quantitative fashion. Figure 1.1 provides a snapshot of the stresses facing producers of dispatchable electricity in systems with significant amounts of variable electricity.

Figure 1.1 shows that the system effects generated by variable renewables can be quite impressive. A modelling effort by GE Energy for the US Department of Energy shows the impact of a 35% share of renewable energy (wind in green, concentrated solar power in orange and photovoltaics in red) in the WestConnect area in the Western United States, which comprises Arizona, Colorado, Nevada,

New Mexico and Wyoming. In a week mimicking the most volatile meteorological conditions of the past three years the demand on dispatchable capacity (the blue line above the white area), varies between -3 GW to more than 20 GW. Clearly the technical and pecuniary system effects on conventional power producers are very substantial under such circumstances.

**Figure 1.1: The impact of 35% renewable energy penetration in the western United States**

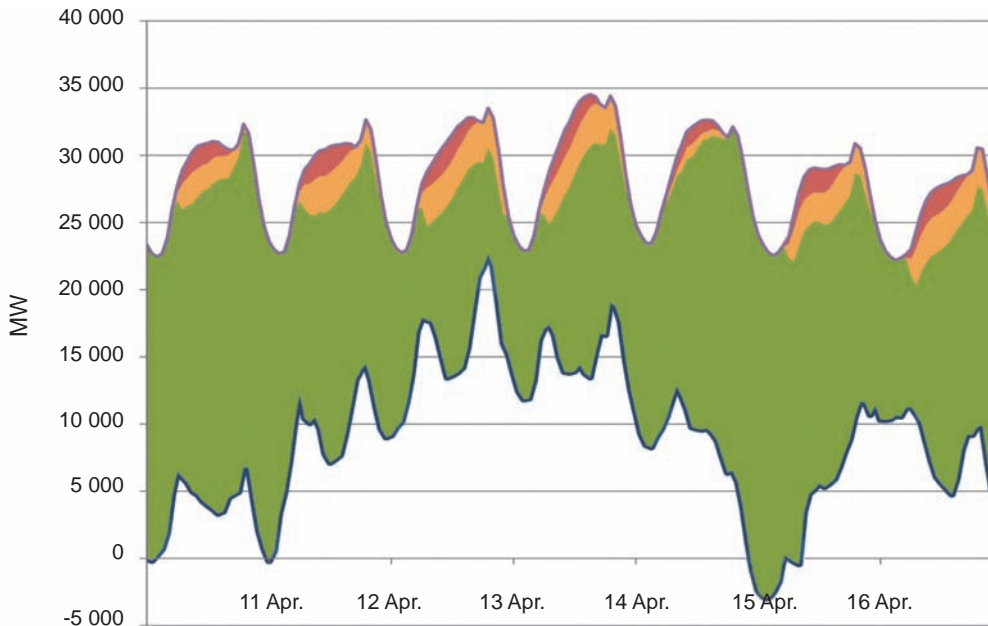

Note: The figure shows the total load curve in MW (upper line) including the contribution of solar PV (red area), the contribution of concentrated solar power (CSP, orange area) and the contribution of wind power (green area). The lower blue line shows the residual load that needs to be covered by conventional power producers (white area).

Source: GE Energy, 2010, p. 14 and IEA, 2011c, p. 31.

While system effects have become an issue primarily due to the advent of significant amounts of variable renewables in the electricity markets of OECD countries, nuclear energy is at the origin of some system effects of its own. These include the need to locate close to cooling sources, a certain configuration of its grid connections (due to the volume of the load being generated as well as the requirement for especially secured on-grid power) or the need to compensate for regular outages. This study thus begins with a presentation of the system effects of nuclear power in Chapter 2.

The inclusion of system costs in the assessment of generating costs to prepare choices on different technology options is vital for informed decision-making. This holds in particular for low-carbon technologies that influence public policy-making in one form or another such as renewables, nuclear energy, carbon capture and storage (CCS) or efficiency improvements.<sup>2</sup> The focus in this study will thus be on renewables and nuclear energy. Renewables are affected by policy primarily through the creation of stable FITs above average market prices, whereas nuclear energy implicates governments through the need for sectoral regulation, waste storage and disposal as well as proliferation safeguards. It is thus

2. It is no coincidence that the technologies that are most subjected to public rather than private decision-making are low-carbon technologies. The latter's economic cost structure with high fixed cost and low variable costs does not match up well with the risk preferences of private investors. Based on financial considerations alone, the latter will always prefer low fixed cost and high variable cost technologies even at comparable discounted lifetime costs. This, however, corresponds to the cost structure of carbon-intensive technologies based on fossil fuels. It is thus comprehensible and, wherever relevant decision-making processes have concluded favourably, justifiable, that public policy takes on a special role in promoting low-carbon technologies.

particularly important in the case of low-carbon technologies that decision-makers have a clear view of the real financial costs of each technology. There can be no cost transparency without considering system costs. Otherwise, implicit subsidisation will be added to explicit subsidisation and substantial hidden costs can lead to unpleasant surprises further down the road.

While nuclear power creates system costs of its own, it remains the only major dispatchable low-carbon source of electricity that is not limited in supply. The advent of large amounts of electricity produced by variable renewables in the decarbonising electricity sectors of OECD countries will affect the economics of nuclear power in a significant way. This concerns both the profitability of existing nuclear plants in the short run and the outlook for nuclear new build in the long run. Existing nuclear power plants will be affected just as dispatchable plants based on gas or coal by the lower electricity prices and reduced demand caused by the subsidised renewables pushing into the market. Due to its relatively low variable costs, however, existing nuclear power plants will do relatively better than gas and coal plants, which are already suffering substantially, in particular in Germany and Spain.

As far as new nuclear plants, which still have to earn back their capital costs, are concerned, the massive influx of variable renewables will gradually transform nuclear power from a provider of baseload electricity to a provider of low-carbon back-up capacity. While the precise cost and the mode of remuneration of such back-up provision still need to be defined, it is quite obvious that receipts from energy-only electricity wholesale markets will be insufficient to cover the costs. However, explorations of additional means of remuneration, in particular through capacity or balancing markets, are already under way and are discussed in Chapter 5.

There is, for instance, evidence that European nuclear power producers are today already gaining today additional revenue in the high-price balancing markets where an increasingly variable electricity supply is adjusted to demand in a 15-minute time frame. This is unlikely to make up for the shortfall in both prices and demand in the day-, month-, quarter- and year-ahead forward markets, in which the vast majority of electricity is traded. The point, however, is that new and alternative means to remunerate dispatchable electricity exist and the question of the profitability of nuclear in low-carbon electricity systems is not one of principle but one of organisation and price.

Fossil-fuel based power producers will, of course, be affected in a similar manner. Their competitive position *vis-à-vis* nuclear will be determined in addition to unit costs by their ability to absorb reduced load factors and to work with more flexible production profiles as well as the carbon price. However, to the extent that electricity systems over the next decades are aiming for near-complete decarbonisation, first coal, then gas will exit the merit order. Barring a technical breakthrough in electricity storage or carbon capture and storage, nuclear power is thus increasingly likely to become the most cost-effective low-carbon solution for dealing with large-scale intermittency.

The study pursues the issue of the interaction between nuclear and variable renewables in a broad and systematic manner. Following this introduction, Chapter 2 will concentrate on the system effects of nuclear power. Chapter 3 will summarise the current evidence from France and Germany on the ability of nuclear power to contribute to the minimisation of system effects through load following in the face of intermittency and proper fleet management. Chapter 4 constitutes the heart of the study as it presents a thorough overview and discussion of system effects as well as the quantitative estimation of the grid effects of different power generation technologies. Chapter 5 will concentrate on the regulatory frameworks necessary to internalise system effects, for instance through appropriate capacity mechanisms that let dispatchable back-up capacity compete with improved interconnections, storage and demand-side management to provide capacity on demand as the intermittency of total load increases. Chapter 6 will provide a glimpse of the future providing perspectives on how smart grids and small modular reactors (SMRs) might contribute to minimise system costs, while Chapter 7 will provide the results of a detailed economy-wide modelling effort of the German electricity sector, which is characterised by a particularly high share of variable renewables. Chapter 8, finally, will draw the principal lessons of the preceding chapters, formulate on their basis four key policy recommendations and conclude the study.

### 1.3 Notions of system costs and their relation to externalities

As previously noted, the study concentrates on grid-based system costs. These are also the only costs that it estimates quantitatively. Clearly, these are not the whole costs that different technologies and, in particular, variable renewables impose on the electricity system, the economy and general well-being and we will come to these further below. System costs are a complex issue and separating them out, categorising and allocating them is a difficult task, all the more so as the relevant protocols are still in the process of being established. An example may be constituted by solar photovoltaic energy which only produces during daytime and is not dispatchable, since its fuel (solar radiation) cannot be stored. In addition to the required subsidies for their deployment, one must consider the added costs for strengthening the distribution and transportation grids, as well as the costs for balancing the grid as solar production changes and providing back-up especially during the evening consumption peaks. If subsidies are provided through feed-in tariffs, subsidy payments may – in certain countries such as Australia – even be due when a surge of PV infeed needs to be curtailed to protect the grid and no usable power is being produced.

Concentrating on the technical externalities, grid-level system costs and only in a second step on the pecuniary externalities, as in this study, constitutes thus a conservative approach. In the following, this section will provide some definitional clarification concerning system effects and externalities to facilitate the reading of this study.

Grid-level system costs already constitute real monetary costs today. They are incurred now as present and future liabilities by producers, taxpayers and electricity consumers. Technically speaking, grid-level system costs are technical externalities that are mediated by the electricity grid. They consist of already monetised (or easily monetisable) cost elements, which are not correctly allocated to those who cause them, primarily the producers of variable electricity. This is due to the institutional particularities of the electricity system, most notably the subsidisation of renewables and the obligation of grid operators to take all electricity produced by renewables regardless of their timing, quantity or load-profile.<sup>3</sup>

Grid-level system costs can themselves be divided broadly into two categories: (1) the costs related to additional investments in the electricity transport and distribution grids required by certain technologies; and (2) the costs for maintaining the supply and demand balance in the electricity system at all times. In detail this makes for the five categories of system costs that this study explicitly assesses in a quantitative manner:

#### Grid-related costs

- *grid connection* (extension of the existing grid to plants outside the current grid area, notably off-shore wind-farms);
- *grid reinforcement* (upgrading the current grid in terms of voltage or load-carrying capability);
- *grid extension* (extension of the existing grid to plants inside the current grid area).

#### Supply and demand balance

- *short-term balancing* (provision of spinning reserves, which are largely a function of the unpredictability of weather changes, to ensure a given level and quality of electricity supply; ramp costs for back-up technologies);
- *long-term adequacy* (provision of dispatchable back-up capacity to satisfy electricity demand at any given moment, see Box 1.1).

Grid-level system costs have a level of immediacy and certainty that goes beyond that of other system effects which include the pecuniary impacts borne by dispatchable power producers, the dynamic de-optimisation of the current production fleet, or the non-monetised externalities of

3. The obligation to take renewable electricity regardless of its load profile is less innocent than it sounds and goes right to the heart of the system cost issue. While it is fashionable to remark that intermittent renewables would always be dispatched due to their low marginal costs this holds precisely only because network operators are obliged to function as aggregators for random load profiles. Without the take-off obligation, renewable operators would need to provide much more stable load profiles and thus internalise at least the part of the system costs they generate that is related to balancing.



electricity production such as impacts on environmental quality or the external security of energy supplies (see below). From an economic point of view it would be entirely correct to internalise grid-level system costs into the plant-level levelised cost of electricity production in order to derive the true economic cost to society of different technologies and to enable policy-makers to make least-cost choices maximising social well-being.

### Box 1.1

#### The true costs of long-term adequacy

Capacity provided by variable renewables such as wind and solar requires almost complete matching by dispatchable technologies in order to provide electricity during the hours when the wind does not blow or the sun does not shine. While estimates of the capacity credit of variable renewables, their ability to fully substitute for dispatchable capacity, vary widely and depend heavily on local circumstances, they rarely exceed 10% of total capacity and decline with rising shares of variable renewables in electricity production. Estimating the costs of such back-up capacity is less straightforward than it seems.

The cost of long-term adequacy depends largely on the position in time where the analysis is situated. The cost estimates of the system effects of variable renewables made under different assumptions vary widely and have thus been carefully distinguished throughout the study. If the analysis is situated in a present where adequate dispatchable capacity to cover peak demand is already available and renewables are forced into the existing system overnight, then adequacy costs are very low or even zero. Throughout this study this short-term snapshot based on the current situation is referred to as *ex post* analysis. In this case, renewables do, in general, not require any additional investments in back-up capacity until the end of the operating lifetimes of the existing dispatchable capacity.

However, if the analysis is situated in a long-term future, where renewables are introduced over time, old dispatchable capacity is retired and new dispatchable capacity has to be introduced only to produce during the moments in which variable renewables are not available, then adequacy costs are substantial. Throughout the study, this is referred to as long-term *ex ante* analysis. An *ex ante* assessment of back-up needs considers a country's energy system a clean slate, where the installed capacity of variable renewables needs to be matched by nearly equivalent amounts of dispatchable capacity (the precise amounts depend on the capacity credit of the renewables) that needs yet to be built and whose fixed costs still need to be paid for. A long-term *ex ante* assessment of back-up capacity needs is also required each time that renewables are considered for satisfying new demand. Chapter 4 reports the figures for such long-term *ex ante* analysis.

If all costs including past capital costs were accounted for correctly, the total costs of the electricity supply system will be higher in the *ex post* than in the *ex ante* case, since the total generation fleet will be uneconomically large. However, most costs would fall on dispatchable producers ("which are there anyway") and not to variable renewables in terms of back-up costs. While it is true that these capital costs are sunk as far as the present generation of dispatchable plants is concerned, it would be an error to transfer this assumption to a new generation of dispatchable plants once the current one has reached the end of its useful life. In the long run, the costs for a least-cost mix of dispatchable back-up technologies thus needs to be taken into account.

The question as to what are the true costs for adequacy in practice is difficult to decide and depends on the time frame. For a share of 10% of renewables in electricity supply, *ex post* analysis is possibly sufficient. For a share of 30% of renewables clearly *ex ante* analysis is warranted as substantial shares of current capacity with sunk capital costs would be retired by the time the target of 30% was reached.

There exists an additional element of grid-level system costs due to the intermittency of wind and solar power that affects producers of dispatchable electricity. Reacting frequently in very short time frames to load changes imposes so-called "ramp costs" on dispatchable operators. Costs accrue due to three factors: an increase in operating costs as staff needs to be permanently available to adjust load frequently and often unexpectedly, an increase in fuel costs as efficiency is affected and lower operating lifetimes of the power plants as frequent load changes translate into higher wear and tear of materials and equipment. While non-negligible in practice, ramp costs have not been explicitly taken into account as a separate item due to a lack of available data.

On the basis of the five cost elements mentioned above that together constitute the grid-level system costs accounted for in this study, Chapter 4 provides an estimation of the "total cost of electricity supply" for six different OECD countries. The total cost of electricity supply includes the plant-level cost of production plus the grid-level system costs associated with each technology. These costs are provided for the currently existing system as well as for hypothetical future systems which include either 10% or

30% of electricity produced by variable renewables (solar, onshore wind or offshore wind). This allows a rough and ready calculation of the surplus costs associated with two different levels of variable renewables both in absolute values and in euros per MWh.<sup>4</sup> One finding from this comparison is that the results differ from country to country. This is due both to the different costs for renewables (both in terms of plant-level costs and grid costs) and the different structures of existing energy systems in OECD countries. Substituting a MWh produced by a high-variable cost gas plant overall produces a smaller economic loss than substituting a MWh produced by a low variable cost nuclear plant.

In addition to the notion of the total cost of electricity supply, the study also considers a notion of “total system costs”. It was said above that grid-level system costs constitute the monetisable portion of the external effects of different power generation technologies mediated by the electricity grid. Total system costs would also include thus external effects that would be difficult to monetise. The total system costs include also the complete list of non-monetised externalities that are not mediated by the electricity grid and that affect a country’s wider economy and well-being beyond the electric power system itself. This broader set of externalities would include:

- environmental externalities (with the exception of CO<sub>2</sub> emissions, which begin to be explicitly or implicitly internalised in most OECD countries);
- impacts on the security of energy supply and a country’s strategic position;
- costs of sector specific regulation, waste disposal (to the extent that costs are not included in prices) and, for nuclear, proliferation safeguards;
- costs of industrial accidents to the extent that they are not covered by insurance arrangements that enter the cost of production;
- costs and benefits of basic and applied research on different technologies;
- spillovers of the development or use of a given technology for local economic development, industrial competitiveness, employment, the trade balance and export potential.

In recent years, one particular category of system effects, environmental externalities, has been increasingly recognised as relevant for private and social welfare. To the extent that such externalities are monetised and emitters are held responsible for their emissions, they can also be integrated into plant-level cost accounting. The 2010 edition of the *Projected Costs of Generating Electricity* (IEA/NEA, 2010) thus imputed a tax of USD 30 per tonne of CO<sub>2</sub> on the emissions of fossil-fuel based generators. To the extent that such monetisation correctly reflects the social costs of the climate change externality the system costs are internalised, i.e. costs are borne by those who cause them, and no longer pose an issue for policy analysis. Another recent NEA study on *The Security of Energy Supply and the Contribution of Nuclear Energy* (NEA, 2010) has quantified, if not monetised, the impacts of different technologies on the security of energy supply.

There is little disagreement among economists that such technical externalities, even if they are not monetised, constitute real impacts on social well-being. Nevertheless, it would be quite impossible to synthesise them in a single monetary metric. Of course, different studies have attempted to monetise at least environmental externalities (see below). The present study, however, confines itself to assess quantitatively only the costs internal to the electricity system, that is the sum of plant-level costs and grid-level system costs, which are referred to as the total costs of electricity supply. This is what consumers will have to pay for their electricity supply *ceteris paribus*. Dynamic effects are considered separately. The study is mindful, however, that there exists a wider notion of total system costs that includes externalities affecting society beyond the electricity sector itself, and provides brief overviews of the most important ones in Section 4.1.

4. The only way to derive such figures at the current state of data availability is to operate under the assumption that the structural composition of the dispatchable portion of electricity supply remains the same. As discussed further below, in theory also the composition of the dispatchable portion of supply is likely to change as variable renewables tend to initiate a shift from high-fixed cost technologies such as nuclear towards low-fixed costs technologies such as open cycle gas turbines due to the reduction in load factors. Depending on government policies, future fuel costs and carbon pricing, the final outcomes are very difficult to predict as operators will compose new least-cost configurations adapted to the new circumstances.

Finally, this study deals with the pecuniary and dynamic effects of variable renewables. These are difficult to grasp conceptually, very difficult to quantify at the current stage of debate and may not constitute welfare-relevant externalities in the sense that grid-level or other technical externalities do. However, they may well constitute the impacts that are currently most acutely felt by electricity producers and may in the long run have the most profound effect on the operations and structure of electricity markets. The three principal effects that fall into this category are:

- *Lower and more volatile electricity prices* in wholesale markets due to the influx of variable renewables with low marginal costs: variable renewables based on wind and solar have zero short-run marginal costs and are thus always dispatched when produced as long as their system costs are not internalised. This means that the traditional supply curve shifts to the right intersecting the demand curve at lower prices. While this is a benefit for consumers in the short run, it also means that electricity producers are no longer able to pay for the fixed cost of their installation, as long as they are not subsidised by feed-in tariffs. To maintain the security of electricity supply, alternative means of financing (feed-in tariffs, contracts-for-difference, capacity payments or other) have to be found, whose cost is, of course, billed back to consumers, while market prices decline. Final prices for consumers may well rise due to the increasing wedge constituted by rising grid tariffs, subsidy payments and the cost of back-up power. In the long run the issues of declining wholesale prices question the very role of the marketplace to provide adequate signals for power generation investments. It is easy to see that the static welfare impacts are ambiguous and that the main implication may lie with the disruption and added uncertainty that this phenomenon brings.
- *The reduction of load factors* of dispatchable power generators (*compression effect*): as explained under point a) due to their low marginal costs renewables will have precedence over dispatchable supply as long as their system costs are not internalised. This means that the load factors of existing capacity will shrink and with it the revenue of traditional power generators. The reduction of load factors thus re-enforces the impact of the decline in prices with all the impacts for the working of electricity markets already mentioned.
- *The de-optimisation of the current structure of production*: while the reduction in average prices and load factors will affect all dispatchable technologies, they will not be felt by each one of them in the same manner. As already mentioned above, in the short run nuclear power with its low marginal costs may well be able to cope with somewhat lower prices, in particular if capital costs have been amortised. Where gas turbines lie idle due to insufficiently high prices, nuclear will go on producing regardless. In the long run, however, the prospect for high fixed cost technologies such as nuclear look bleak with reduced load factors. The optimal mix for the residual load curve created by the influx of renewables will entail a shift towards technologies with lower fixed costs. Of course, such a shift could be counteracted by appropriate carbon policies or higher gas prices. However, nuclear operators must be watchful to install the appropriate safeguards right from the start, as the revenue risks come both from the side of prices as well as quantities.

The question remains whether such dynamic pecuniary externalities contribute to an overall increase in the cost of the energy system or primarily constitute transfers between competitors in a dynamically evolving system. The question is complex and is discussed in the following section. In any case, quantifying the economic costs of such dynamic, pecuniary system effects would have largely exceeded the objectives of the present study. Nevertheless, given their importance, substantial space has been dedicated both in the next section and in Section 4.3 to better understand them and provide an indication of their magnitude.

Both technical and pecuniary externalities have real impacts on electricity producers based on nuclear electricity, coal or gas. However, operators of conventional power plants are not undergoing these system effects in a passive manner. A key response to changing load patterns has been a more strategic approach to power plant management both at the level of the fleet and at the level of the individual power plant. Chapter 3 will discuss both strategies as applied to nuclear reactors in detail relying on new empirical evidence from France and Germany, the two countries with the most experience in these fields.

## 1.4 The question of pecuniary externalities

System effects in the electricity sector are impacts on the profitability of a company or the well-being of an individual above plant-level costs to supply electricity at a given load and given level of security of supply. Formally, such system effects are externalities, whose textbook definition is “an effect that is not accounted for by the one who causes it”. The essence of an externality is the lack of reciprocity between those who are affected by them to those who cause them. Usually markets establish such feedback mechanisms (“I give to you, you pay me; I receive from you, I pay you.”), but in the case of externalities in general and system costs in particular such markets do not exist and system costs are hence over-produced.<sup>5</sup> There exists currently no instrument to internalise system costs into the individual cost functions of those who cause them, which means that system costs are currently being absorbed by the investors in dispatchable capacity as well as network operators, the latter being able to pass on the added costs to electricity consumers.

This is due to so-called “transaction costs”, a term which covers issues such as complexity of information, absence of identifiable causal links, diffuse nature of impacts, unclear legal situation and so forth. In such cases, the price mechanism is incapable of organising the usual reciprocal exchanges between those who create a good or a bad and those who enjoy it or suffer from it. Consequently, negative externalities are over-produced and positive externalities are under-produced.

This creates less than an optimal situation and forces governments or regulators to step in to remedy the situation. In the case of system effects in the electricity sector, the relative newness of the issue, the lack of firm information and the lack of an appropriate allocation of responsibilities all have contributed to a situation, in which system effects in the electricity sector are part of a general “entropy of costs”, where costs rise and profits fall without reasons that are clearly identifiable.

While this situation is analytically covered by the notion of externality, the study will by and large avoid the term for two reasons and use primarily the “grid effects” or “system effects”. First, the term externality is very much associated with environmental externalities. This holds in particular for the power generation sector, which in the 1990s was the subject of three influential and since updated studies on environmental externalities.<sup>6</sup> The environmental impacts of electricity generation, in particular in the area of climate change, remain of course an important issue. The NEA discussed this in a publication on *Carbon Pricing, Power Markets and the Competitiveness of Nuclear Power* (NEA, 2011). This current study, however, will focus primarily on the technical and physical interactions between different producers mediated by the electricity grid rather than on the environmental impacts of different technologies.

Second, using the terms “system effects” and “grid effects” underscores to which extent the electricity sector has to be thought of as one interconnected system. Rare cases of auto-production apart, all production and consumption really does pass through the same transmission lines where everyone’s production and consumption decisions interact with those of all others. Limited storage capacity implies that electricity demand and supply are inelastic. This means production and consumption need to be balanced second-by-second through the physical grid. There is little scope to exit the network even if only temporarily for either consumers or producers. The multiple unaccounted-for impacts that different producers impose on each other in the electricity system are thus of a slightly different nature than the one-way relationships between one large producer of an environmental bad and a multitude of hapless victims that is usually evoked by the term externality. The use of the terms “system effects” and “grid effects” also indicates that the study concentrates primarily on those externalities linked to the use of a common grid for the transport and distribution of electricity.

However, before entirely discarding the term “externality”, one needs to clarify the distinction between technical and pecuniary external effects introduced by Scitovsky, which is relevant in this context (Scitovsky, 1954). Technical externalities are not only impacts on the well-being of a party, which are not taken into account by the party that creates it, but are also characterised by a strictly

5. Lack of internalising the cost of a negative externality leads the producer to produce more than if it were incorporated.

6. The three studies are: EC (1995); ORNL/RFF (1992-1998); and Pace University Center for Environmental Legal Studies *et al.* (1990). Recently, the web-based NEEDS-project, which stands for New Energy Externalities Development for Sustainability and is sponsored by the European Commission, has established life-cycle inventories for different scenarios of future electricity supply ([www.needs-project.org](http://www.needs-project.org)) and has updated many previous externality estimates.

asymmetric relationship, in which the affected party has no means of responding. This is, for instance, obvious in the case of environmental externalities, where pollution or ecosystem destruction creates a physical one-way link between both parties. Another frequently invoked example is constituted by congestion externalities, where any individual driver does not take into account the delay he causes to all other drivers.

Next to negative environmental externalities, the most significant in economic terms are *positive* network externalities. Connecting an individual consumer to a power plant would be prohibitively expensive. However, each additional customer in the area reduces the average cost for all involved since the cost for connecting the additional customer is small. The physical link through the grid, however, not only links customers to a producer but also links all producers with each other. This is why in the electricity system changes in the level of production of one company immediately have impacts on the production and the profitability of another company.

Other than in electricity, network externalities are important in the information and communications industry. They need not necessarily be mediated by a physical grid. The adoption of particular software, the “buzz” created by viral marketing around a particular product, the positive spillovers of a company’s R&D spending or a “cluster” of likeminded researchers pushing each other are all examples where positive externalities ensure that the final result is greater than the sum of the individual contributions. Whether negative or positive, technical externalities lead to suboptimal situations as their unconstrained production is either too high or too low and require outside intervention by governments or regulators. This is also the case with the “grid-level system costs” discussed and quantified in this study.

Pecuniary externalities are different. While they can impose highly unwelcome impacts on certain parties, they do not, or at least not immediately provide a rationale for public intervention. They are thus of a different nature than technical externalities, which are usually implied when the term externality is used. This is due to the fact that pecuniary externalities operate *through the price mechanism*, which at least in principle implies reciprocity. For instance, the entry of a new, lower-cost power producer into the market will reduce electricity prices and profits for incumbent producers. Pecuniary externalities thus have very real effects on the well-being of other parties. Nevertheless, they are in principle not considered a suboptimal configuration of affairs or requiring government intervention.

The reason is that any change operating through the price mechanism allows a reaction by the affected parties. Prices, by definition, are set through bilateral or multilateral interactions. The high-cost power producers in the above example may now make efforts to deliver electricity at lower cost or the electricity consumers affected may increase their energy efficiency and demand, which in return will affect quantities, prices and profits through the price mechanism establishing new equilibrium levels for all involved. This is not to say that the affected parties will not suffer a decline in their profits or well-being. However this is the result of new inescapable realities in an evolving economic system characterised by “creative destruction” in Schumpeter’s expression. The decisive difference between a technical (real) externality and a pecuniary one is that the latter does not constitute a suboptimal situation from the point of view of maximising the total welfare of all participants. Government interventions such as, for instance, punishing low-cost producers through higher taxes or similar, would only make matters worse and reduce total well-being.

So much for the general theoretical case, however in practice the question whether the reduced profitability of the dispatchable competitors of renewable technologies driven by subsidies results in added costs for the electricity system cannot be decided as easily. On the one hand, a new technology driving out an established technology does not constitute a system cost but is the essence of economic competition. Yet, there are two counterarguments to this view. First, as long as the technology that is less expensive in the short run is subsidised, natural movements towards market equilibrium are suspended. Without subsidisation, renewable technologies with their high fixed costs would be the first victims of lower electricity prices due to their own low, short-term costs and investors would quickly hesitate to invest in them.

Second, if the declining profitability of dispatchable technologies in primary electricity markets will not be compensated by complementary revenue streams such as capacity payments, their shares will quickly decline. This, however, will lead to increased price volatility with large price spikes in order to

finance the remaining generators. Given the resulting impacts on system stability, investment conditions and consumer preferences, the resulting system costs may well be higher than in a system where dispatchable producers were unaffected from the price impacts of variable renewables. Hence, total system costs are higher and alternative arrangements induced by public intervention – which may just be confined to discontinuing subsidy payments – would increase total welfare.

A particularly complex and empirically important example of such pecuniary externalities is at the heart of this study on system costs in the power sector. In several European OECD countries, but particularly in Germany, the advent of large amounts of intermittent electricity generated by solar power and wind power has been leading to large technical externalities with network operators and other producers, including nuclear energy, being forced to accommodate large swings in the production of renewable energy. It has also led to important financial externalities with average prices tending to be lower and price volatility higher than they would have been otherwise. A particular striking evidence of this phenomenon is the fact that repeatedly electricity wholesale prices were *negative* due to strong wind-power production during periods of low demand (see Figure 1.2).

**Figure 1.2: Wind power and negative prices on the German electricity wholesale market**

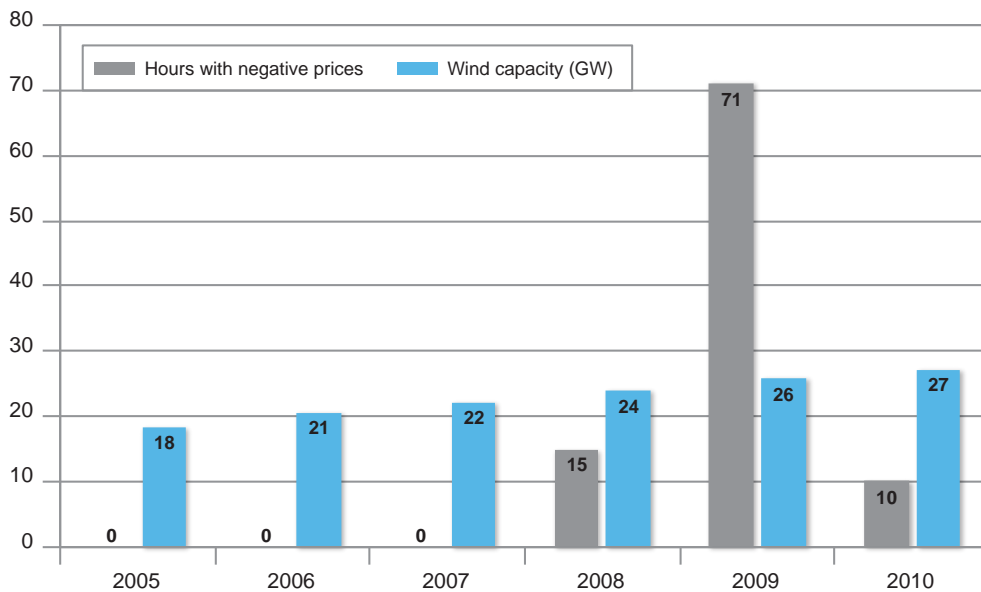

Source: Based on European Energy Exchange Market (EEX); for 2010, first six months only.

It does not require elaborate economic theory to show that negative prices constitute a commercially very awkward reality. This holds in particular for baseload producers such as nuclear which rely on high load factors and predictable prices in order to recoup their high fixed costs. Figure 1.2 also shows the additional incidence of two further factors, which both have a direct bearing on this project. First, in 2009 the new Federal Law on Renewable Energies (*Erneuerbare Energiengesetz* or *EEG*) came into force that required all operators of renewable energies to sell their output through the wholesale market, which quickly led to increased price volatility and an astonishing 71 hours, almost 1% of total hours, of negative prices. Second, one can also see that the number of negative hours fell sharply between 2009 and 2010. Other than improvements in the accuracy of weather forecasts this is due to the fact that German operators, including the operators of nuclear power plants, learnt quickly to engage in load following in order to soften the price impacts of sudden surges in wind and solar power.

The counter-intuitive phenomenon of negative prices in the electricity markets of OECD countries with significant amounts of variable renewables is far from being a uniquely German phenomenon. The Canadian province of Ontario thus disbursed CAD 35 million in the first six months of 2011 for the right to export electricity produced in Ontario to Quebec or the United States during the 95 hours when prices

were negative. These distortions are prognosticated to become even more pronounced in the future as new wind and solar capacities are being installed (Enerpresse, 2011). In Southern California, the annual distribution of electricity prices also contains a substantial tail with negative prices (Forsberg, 2012, p. 12).

Yet after what has been said above about pecuniary externalities, are lower average prices and greater volatility just the consequence of new realities to which everybody just needs to adjust? Not quite. In a competitive market where a single price defines the incentive for all participants to produce or to consume electricity in a symmetric fashion, the impacts of variable renewables on the level and volatility of price, would indeed only reflect the realities of a changing market. Consumers and distributors would need to decide how to cope with intermittent supply from renewables-only providers and those providers would have to consider whether the intermittent nature of their technologies was competitive against traditional power generation by dispatchable technologies such as nuclear, coal and gas. However, as has been pointed out above, variable renewables do *not* face the same incentives as other technologies.

In most OECD countries, wind and solar power receive fixed feed-in tariffs for every MWh fed into the electricity system regardless of market prices. Such asymmetric treatment isolates variable renewables from the impacts they themselves inflict on the market price, which affects only technologies *not* benefiting from such feed-in tariffs. In other words, conventional producers can produce or not produce, have high or low costs; they will never affect the renewable producer who will generate electricity as a function of the weather but regardless of market conditions. Such lack of a feedback mechanism, however, is the defining hallmark of a true, *technical* externality that does constitute an economically suboptimal situation. In particular, the current situation will lead to underinvestment in dispatchable technologies and thus increase security of supply risks at times of low renewable production due to unfavourable meteorological conditions.

The pecuniary system effects of variable renewables thus constitute a paradox. In principle, no pecuniary externality that passes through the market should generate economically suboptimal situations or require government intervention as the market should provide reciprocity between those that generate the original effect and those that are affected by them. However, since the very renewables that generate the pecuniary effects are themselves shielded from market outcomes by way of pervasive subsidisation this no longer holds. The pecuniary effects of variable renewables that are shielded from market price through feed-in tariffs *do* therefore constitute welfare relevant externalities that need to be taken into account in the evaluation and adaptation of current policies.

This is not to say that all support for low-carbon electricity must necessarily lead to suboptimal configurations. After all, the original idea behind the support for renewable energies was motivated by two justifiable public policy objectives: the reduction of climate change-inducing greenhouse gas emissions and the support for domestically produced rather than imported forms of energy. In other words, the objective was to internalise the externalities of climate change and import dependence. However, the intellectually coherent manner to proceed towards this internalisation would have been to tax the externality itself, i.e., to impose taxes on greenhouse gas emissions and the use of imported fuels, rather than to override the technology choices of the market. Current feed-in tariffs schemes are thus at the heart of the technical and pecuniary externalities created by intermittency. Furthermore, such selective subsidisation entrenches the problem and impedes progress towards its internalisation.

Feed-in tariffs thus drive a wedge between the wholesale market price that is received by conventional producers and the price paid by consumers through higher payments to the network operators who recuperate the cost of the feed-in tariffs as well as payments for back-up capacity. The latter may come in the form of capacity payments or increased prices in the short-term adjustment market. This reduces the profitability of alternative means of electricity production, which nevertheless remain indispensable to ensure the security of supply. It also poses the question to which extent the wholesale electricity market is still the relevant instrument for matching demand and supply and for co-ordinating investment decisions. Independently of social preferences for one technology over another, the current trend of superposing market outcomes with different layers of policy instruments to achieve certain outcomes poses serious questions concerning the transparency and ultimately the sustainability of electricity sectors in OECD countries.

## 1.5 A new role for nuclear energy

The emphasis in the previous sections on system effects due to variable renewables that affect all providers of electricity has moved the discussion away from the role of nuclear energy in this context. Nuclear energy does indeed create a number of specific system effects, in particular with respect to siting and to the specific requirements that it demands in terms of transmission infrastructure and grid access. Both issues are ultimately linked to the need to ensure continuous cooling of the reactor core. Nuclear power plants thus need to be located close to sufficiently large water sources that can provide continuous cooling. This constitutes a constraint on location as well as an environmental externality, since the residual heat can affect the ecology of the water source. Favourable seismic conditions and a minimal distance from urban centres are additional criteria for the location of nuclear power plants.

The key system effect of nuclear power, however, is its demand on the strength and reliability of the connection to the electricity grid. Due to the large size of a nuclear unit of up to 1 600 MW, nuclear power plants require strong power lines capable of carrying large amounts of electric load. These lines are typically laid out for 400 kV but can go up to 750 kV and even 1 000 kV (Japan). A frequently cited rule-of-thumb indicates that grid upgrades may contribute up to 10% to the cost of a new nuclear power plant. Depending on the manner of allocating grid costs, the necessary reinforcements are borne by the system as a whole or by the power plant operator. In the latter case, the costs would be internalised and then the real system costs would be limited to the relatively small costs of reducing the flexibility of the grid lay-out in terms of optimising the complementarities between production and transport in bringing electricity to the centres of consumption.

Most important, however, are the demands on the reliability of electricity to assure a continuous power supply to the plant in order to provide electricity for the pumps of the cooling system at all times. The recent accident at the Fukushima Daiichi plant has starkly underlined the importance of the continuous availability of both grid-reliant and autonomous back-up cooling systems even under the most adverse circumstances. In terms of system effects, this puts certain demands on the configuration of the grid, the availability of grid-linked back-up power in the vicinity of a nuclear power plant as well as on the quality of the electricity supply in terms of voltage and frequency disturbances.

Beyond the system effects generated by nuclear energy itself, a key question this study sets out to answer is to which extent nuclear energy is capable of accommodating load variations due to variable renewable production through load following. An issue is thus the ability of nuclear power plants to react flexibly to the load variations on the electricity grid due to the intermittency of wind and solar power. Nuclear power is frequently considered a pure baseload technology working at the rated power level for long periods of time. This baseload working mode has two advantages: (a) technical, commercial and organisational simplicity; and (b) it is the commercially most advantageous form of operation in a context of stable prices for electricity. High load factors over long periods of time are essential to pay back the investment costs of high fixed-cost and low variable-cost technologies such as nuclear energy.<sup>7</sup> Unsurprisingly, nuclear energy is thus used in baseload mode in most OECD countries.

However, there may be situations in which the operators of nuclear power plants may decide to depart from a continuous mode of operations at maximum capacity levels:

- Lower prices in response to massive load additions by variable renewables, especially prices falling below operating costs will prompt producers, including the operators of nuclear power plants, to reduce load in order to re-establish supply and demand equilibria at more favourable prices; this is not only an issue for the future but a real and pressing concern in several OECD countries already today (see Box 1.2).<sup>8</sup>

7. A high ratio of fixed costs to variable costs is a characteristic that nuclear energy shares with most renewable technologies. The importance of stable prices under such circumstances is the economic justification for feed-in tariffs. Selective stabilisation of revenues for particular technologies will isolate them from market forces, however, and contribute to system effects.

8. The Franco-German EEX power market has not only seen 71 hours of *negative* prices during 2009 but also 577 hours of prices below USD 15, which may be considered an order-of-magnitude figure for the operating costs of a nuclear power plant.



- In countries where nuclear power constitutes a large share of the electricity sector, such as the 78% of supply in France, operators of power plants will modulate their load during night-time and other periods of low demand, week-ends for instance, in order to bring total system load in line with demand.

### Box 1.2

#### How large is the role of variable renewable technologies in OECD countries today?

Not all electricity produced from renewable energy sources is subjected to intermittency and uncertainty due to meteorological changes. Electricity produced from run-of-the-river hydropower, biomass or geothermal heat is dispatchable. However non-dispatchable renewable resources such as wind and solar constitute not only most the important but also the fastest growing renewable technologies in OECD countries. The 2010 IEA statistical report *Electricity Information 2010* (IEA, 2010) indicates that while due to the global economic crisis OECD electricity consumption actually fell in 2009 by 4.5% from 10 744 TWh to 10 295 TWh, electricity produced from wind and solar increased by 17% from 204 TWh to 239 TWh.<sup>9</sup> Thus 2.3% of electricity in OECD countries was produced by wind or solar sources in 2009. While this average figure might seem low, it hides big differences in regional or national circumstances. The share of wind and solar in total electricity supply in OECD Europe in 2009 was thus 4.3% compared to 1.6% in OECD North America and only 0.7% in OECD Pacific. In individual European countries, the shares are such that they can indeed make a difference to the working of the electricity system. Wind and solar thus contributed 19% to the electricity supply in Denmark, 15% in both Portugal and Spain and 7.3% in Germany during 2009.

In order to gauge the true magnitude of the impact of intermittency one needs to be aware of two additional facts. First, precisely due to intermittency, the total shares of wind and solar power in total electricity supply vastly underestimate their contribution when the wind is actually blowing and the sun is shining. According to the IEA/NEA 2010 Projected Cost study, load factors in OECD countries vary between 22% (Italy) and 41% (United States) for wind and between 10% (Netherlands) and 25% (France) for solar photovoltaic (PV). Assuming an entirely realistic average load factor for wind-power turbines of 25%, this means that the share of wind on windy days is four-fold its average figure. This means, for instance, that the Danish system can only be balanced by being closely integrated with the Nordpool electricity market with its ideal balancing conditions due to the almost exclusive reliance on hydropower by Norway. Germany, Portugal and Spain, however, have to devise new means of absorbing sudden surges in load produced by wind turbines, among which for the countries with nuclear energy load following by nuclear plants figures prominently.

The second issue is the strong projected increase in new wind and solar capacity, especially in Europe. In 2009, renewable technologies constituted 62% of all new capacity installed in Europe, the vast majority of which were wind and solar. (EC, 2011b) The European Union has also committed itself to increase the share of renewable energy consumption to 20% by 2020. Given the inertia of the transport sector in this respect, this implies increasing the share of low-carbon technologies in the electricity mix from 45% today to around 60% by 2020 (EC, 2011c). Taking into account the accident at Fukushima Daiichi, the IEA's *World Energy Outlook 2011* (IEA, 2011b) assumed that the European Union's electricity production from nuclear will remain roughly stable until 2020 at 885 TWh per year and that hydro will increase only slightly from 328 TWh in 2009 to 353 TWh in 2020. Given the gradual decline of production from coal- and oil-fired power plants and the forecasted increase of total electricity consumption from 3 170 TWh in 2009 to 3 566 TWh in 2020, this means that the electricity produced by wind- and solar-power will need to expand substantially. The WEO 2011 already assumed an expansion by 250% of wind power from 133 TWh in 2009 to 365 TWh in 2020 and an almost five-fold increase in solar power from 14 TWh to 64 TWh over the same period. This makes for a compound average annual growth rate of 10% from 2009 to 2020. In 2009, the same rate of increase in the OECD stood already at 17%.

Given the large share of nuclear in France and the strong impacts on prices from significant amounts of renewable energy in Germany, where the installed capacity of both wind and solar is now in the order of about 30 GW for each of them, these are the two OECD countries which have the largest experience in modulating the load of their nuclear power plants. On the basis of the French and the German experience and contrary to widespread perceptions, nuclear power is quite well equipped to handle such load variations by way of different operational changes.

9. Of these 216 TWh or 90% were wind power and 20 TWh and 8.4% solar power, the remainder is made up by other non-dispatchable renewable sources such as tide, wave and ocean power. Due to IEA statistical conventions all three categories are reported together for individual regions or countries. The quoted production number or shares for "wind and solar" thus always include a sliver of a contribution from marine resources.

Just as any other electricity producer connected to the grid, nuclear power plants participate in primary and secondary frequency control in order to maintain the frequency on the grid stable. In France, for instance, primary frequency controls in the milli-Hertz range supposes load variations between +2% and -2%, whereas secondary frequency control – for instance in response to a sudden rise in imports – requires load variations between +/- 5%. The ability to contribute to primary frequency control needs to be permanent. In other OECD countries technical requirements for operators are comparable.

The capability of nuclear power plants to engage in load following proper, however, goes beyond the demands of frequency control. Currently, the European Utility Requirements (EUR), a handbook of industry-defined performance standards, demands the capability to accommodate two cycles (from the maximum to the minimum level and back) per day, 5 per week or 200 per year. Concerning the ramp rates, a minimum of 3% per minute of power for most of the total range is required but 5% per minute are usually possible. In an emergency, a single descent to the minimum at a speed of 20% per minute is required. Chapter 3 provides more detail on the load following capabilities of nuclear power plants.

For operators and engineers the precise performance of nuclear reactors in terms of load adjustment is, of course, critically important. However, at the level of this study it is evident that at 200 cycles per year at 3%-5% per minute nuclear reactors are flexibly enough to react to load changes roughly on par with the performance of coal-fired power plants and slightly below that of gas-fired power plants. Visions of decarbonised power systems with significant amounts of both renewables (most of them likely to variable) and nuclear energy, perhaps including some hydropower storage and gas-fired generation, are thus conceivable from a technical point of view.

Ultimately, this study on the system effects of nuclear power and its ability to integrate the system effects stemming from variable renewables is about the structure and sustainability of progressively decarbonising electricity sectors in OECD countries. This process is well under way. The triple objective of the European Union (EU) to reduce carbon emissions and to raise energy efficiency by 20% each as well as to consume 20% of renewable energies all by 2020, the low-carbon initiatives in the United States, the electricity market reform (EMR) in the United Kingdom, the introduction of a carbon tax in Australia, new investments in low-carbon technologies in Asia in both nuclear (Republic of Korea) and renewables (Japan) all point into the same direction: OECD countries will emit less CO<sub>2</sub> per kWh in 10 years time than today. This means that in an age of decarbonisation the co-operation of nuclear energy and variable renewables in the context of liberalised electricity markets will have to be organised.

This does not imply exclusiveness of low-carbon sources in the short and medium run. For some years to come, gas-fired generation due to its good flexibility and low capital costs will continue to be called upon to serve as a buffer for short-term load variations where and when additional flexibility resources are required. However, while less carbon-intensive than coal, gas does emit between 300 and 400 kg of CO<sub>2</sub> per MWh. The *Energy Roadmap 2050 – State of Play* by the European Commission (EC, 2011c), cited above, speaks of a “nearly 100%” decarbonised power sector in 2050. This does not leave much room for fossil fuel-based technologies. In the long run, renewables, many or even most of them variable, and nuclear energy will need to learn how to coexist on their own. The sooner they start the necessary learning process to arrive there, the better.

## References

- EC (1995), *ExternE: Externalities of Energy*, European Commission, Directorate-General XII, Science, Research and Development, Brussels, Belgium.
- EC (2011a), *A Roadmap for Moving to a Competitive Low Carbon Economy in 2050*, COM (2011)112 final, European Commission, Brussels, Belgium.
- EC (2011b), *Energy 2020: A Strategy for Competitive, Sustainable and Secure Energy*, European Commission, DG Energy, p. 6, Brussels, Belgium, [http://ec.europa.eu/energy/publications/doc/2011\\_energy2020\\_en.pdf](http://ec.europa.eu/energy/publications/doc/2011_energy2020_en.pdf).
- EC (2011c), *Energy Roadmap 2050 – State of Play*, European Commission, DG Energy, p. 2, Brussels, Belgium, [http://ec.europa.eu/energy/strategies/2011/doc/roadmap\\_2050/20110503\\_energy\\_roadmap\\_2050\\_state\\_of\\_play.pdf](http://ec.europa.eu/energy/strategies/2011/doc/roadmap_2050/20110503_energy_roadmap_2050_state_of_play.pdf).
- Enerpresse (2011), “L’Ontario ne sait plus quoi faire de son électricité”, *Le quotidien de l’énergie*, No. 10373, 27 July 2011, p. 4.
- Forsberg, C. (2012), *Rethinking the Nuclear Energy Role in a Carbon-Constrained World: Coupling Fuels and Electricity Production*, Presentation at 2012 International Congress on Advances in Nuclear Power Plants (ICAPP), American Nuclear Society, 24-28 June 2012, Chicago, United States.
- GE Energy (2010), *Western Wind and Solar Integration Study: Executive Summary*, prepared for National Renewable Energy Laboratory, US Department of Energy, Washington, D.C., United States, [www.nrel.gov/wind/systemsintegration/pdfs/2010/wwsis\\_executive\\_summary.pdf](http://www.nrel.gov/wind/systemsintegration/pdfs/2010/wwsis_executive_summary.pdf).
- Gibson, C. (2011), *A Probabilistic Approach to Levelised Cost Calculations for Various Types of Electricity Generation*, Institution of Engineers and Shipbuilders in Scotland (IESIS), [www.iesisenergy.org/lcost/LCost-Paper.pdf](http://www.iesisenergy.org/lcost/LCost-Paper.pdf).
- IEA (2010), *Electricity Information*, International Energy Agency, OECD, Paris, France.
- IEA (2011a), *Electricity Information*, International Energy Agency, OECD, Paris, France.
- IEA (2011b), *World Energy Outlook 2011*, International Energy Agency, OECD, Paris, France.
- IEA (2011c), *Harnessing Variable Renewables: A Guide to the Balancing Challenge*, International Energy Agency, OECD, Paris, France, pp. 31-32.
- IEA (2011d), *CO<sub>2</sub> Emissions from Fuel Combustion*, International Energy Agency, OECD, Paris, France.
- IEA/NEA (2010), *Projected Costs of Generating Electricity – 2010 Edition*, International Energy Agency and Nuclear Energy Agency, OECD, Paris, France.
- NEA (2010), *The Security of Energy Supply and the Contribution of Nuclear Energy*, Nuclear Energy Agency, OECD, Paris, France.
- NEA (2011), *Carbon Pricing, Power Markets and the Competitiveness of Nuclear Power*, Nuclear Energy Agency, OECD, Paris, France.
- ORNL/RFF (1992-1998), *Estimating Externalities of Fuel Cycles*, 8 vols., Oak Ridge National Laboratory and Resources for the Future, McGraw-Hill/Utility Data Institute, Washington, D.C., United States.
- Pace University Center for Environmental Legal Studies, Ottinger, R.L., D.R. Wooley, N.A. Robinson, D.R. Hodas and S.E. Babb (1990), *Environmental Costs of Electricity*, Oceana, New York, United States.
- Scitovsky, T. (1954), “Two Concepts of External Economies”, *Journal of Political Economy*, 62, pp. 143-151.
- UK Parliament Energy and Climate Change Committee (2012), *The Economics of Wind Power: Written Evidence*, London, United Kingdom, Available on [www.publications.parliament.uk/pa/cm201213/cmselect/cmenergy/writtev/517/517.pdf](http://www.publications.parliament.uk/pa/cm201213/cmselect/cmenergy/writtev/517/517.pdf).



## Chapter 2

# The effects of nuclear power at the level of the electricity system

While the issue of system effects has gained increasing importance due to the deployment of significant amounts of variable renewables in the integrated electricity systems of OECD countries, there exist a number of system effects that are unique to the construction and operation of nuclear power plants. Before presenting the system effects of nuclear themselves, the first section of this chapter will provide an introductory description of the electrical system and its operations. This will provide a common understanding and terminology not only for this chapter but for the study as a whole, in particular of the grid-level system effects that are central to this study. The key system effects of nuclear power relate to its specific siting requirements as well as the conditions that it poses for the layout and technical characteristics of the surrounding grid. After the introduction, Section 2.2 thus analyses the criteria and requirements for siting a nuclear power plant. Siting constraints may affect the overall economics of the nuclear power plant, via a longer time for site selection, additional investment costs for design safety features or reduced overall efficiency of the plant. However, those costs are mainly borne by the nuclear power plant developer and only impose limited additional costs on the electricity system as a whole. Section 2.3 will then analyse the special conditions that nuclear power plants impose on the electrical system at the level of the transmission. These include the higher requirements concerning grid stability and security, the specific requirements on grid layout due to the large size of a nuclear unit, as well as the interaction between the overall generation system and nuclear plants due to the latter's operational characteristics. Finally, Section 2.4 gives some insight into the costs of integrating the NPP into the grid.

### 2.1 Nuclear power plants as part of the electrical system<sup>1</sup>

The electrical power system is a complex structure that guarantees the production, transmission and distribution of electrical power to final users. It is composed of a generation park consisting of different production groups (hydroelectric, fossil, nuclear, solar, wind, etc.), a transmission grid carrying the electricity over long distance at high voltage, power stations that convert high voltage electricity to a lower voltage and a distribution grid that bring electricity to end-customers at low voltage. One or several transmission system operators (TSOs) assure the efficient operation, stability and safety of the electrical system at regional and national levels.

Electricity is generated by power plants at a relatively low voltage (ranging from 10 kV to 50 kV, depending on the size of the power station) and is transformed into high voltage electricity by step-up transformers at the stations' switchyards. The transmission lines carry electric power over long distances at low current and high-voltage (generally between 100 kV and 800 kV, but up to 1 000 kV in some countries), thus minimising electrical losses.<sup>2</sup> At the interface between the high voltage transmission lines and the distribution systems, an electrical substation uses transformers to "step down" the transmission line voltage to the lower voltage of the end-consumer (ranging from 15 kV for medium-level

1. This section relies mainly on the contribution from Prof. W. D'haeseleer (D'haeseleer, 2011).

2. Energy losses due to the electrical resistance and consequent heating of the cables are proportional to the square of the current, the length of the cable and the resistivity of the material, and are inversely proportional to cross-sectional area. Thus, for the same power transmitted an increase of the voltage of a factor 10 and a consequent 10-fold current reduction would lower by a factor of 100 the energy lost by conductor resistance. Typical losses for the United Kingdom and the United States are around 7% of the energy passed through the transmission and distribution networks.

industries, to around 200 or 100 V for private users). Substations also include electrical switches and circuit breakers to protect the transformers and the transmission system from electrical failures on the distribution lines.

The transmission grid is composed of several voltage levels interconnected through transformers. The transmission networks have a complex topology with a meshed structure constituted by several redundant lines: redundancy limits the consequences of a single line failure, the power being rerouted through other lines according to Kirchhoff's laws.<sup>3</sup> The transmission grid consists mainly of three-phase alternating current (AC) overhead lines, but sometimes AC underground cables are used in densely populated areas or for undersea transmission. By balancing generation and demand, TSOs keep the electrical system synchronous with a fixed frequency (50 Hz or 60 Hz generally). Electricity suppliers have to fulfil technical requirements to support the stability of frequency and voltage.

High voltage direct current (HVDC) technology has been utilised for bulk transport over very long distances, both as overhead lines or cables, because it is cheaper and easier to operate than AC lines. Over very long distances, lower electricity losses and reduced construction costs of a DC line can offset the additional cost of the AC/DC converter station at both ends of the line. HVDC lines are also used to transmit power between non-synchronous areas.

The distribution grid usually has a radial, i.e. non-meshed, layout, with electrical substations that reduce voltage and redistribute the electricity to customers. Only AC is used. There still are many open-air lines, especially in not densely populated areas, but the current tendency is to use mainly underground cables in urban areas.

### **The operation of the electric grid**

The operation of an electric power system involves a process of forecasting the demand for electricity, scheduling and operating a large number of power plants to meet that varying demand and transmitting the electricity from the generating plants to the customers load points.

The electricity demand (load curve) has a characteristic periodic pattern that reflects the needs for cooling and heating, the industry demand, etc. A typical weekly load curve is shown in Figure 2.1: it represents the demand from the Electric Reliability Council of Texas (ERCOT) during three weeks in 2005. In Texas the peak load occurs in summer, around mid-day (orange curve), while demand in winter and spring ranges between 35% and 70% of the peak value. The timing of the peak demand depends on geographical location, meteorological conditions and the degree of industrialisation relative to activities in the commercial, service and residential sector of an area/country. For example, in the majority of European countries the annual peak demand is in winter time (December or January) at about 17:00 h-18:00 h, whereas in more sunny climates such as Greece or Italy, the peak may well be in the summer around noon because of demand for air-conditioning.

To meet the variable electricity demand, utilities operate a variety of power plant types. Baseload plants, such as nuclear, coal-fired or some hydroelectric,<sup>4</sup> are used to meet the large constant demand for electricity. Baseload power plants are characterised by high capital cost, low variable costs and lower total cost of electricity production; for that reason operators tend to run those plants continuously at full output. Load variation, from minimum demand to maximum demand, is normally met with cycling plants, such as natural gas and coal, which have lower capital cost but higher variable costs (mainly fuel). Peaking plants (generally oil-fuelled) are used to provide for peak load and are therefore operated for only a few hundred hours per year.

3. The two Kirchhoff laws describe the flow of electric current through an integrated system and indicate that electricity will take the way of least resistance rather than the geographically shortest route. Law one states that at any node in an electrical circuit, the sum of currents flowing into that node is equal to the sum of currents flowing out of that node. Law two states that in a closed loop the sum of the products of the resistances of the conductors and the currents in them is equal to the total electromotive force (voltage) in that loop.

4. Hydroelectricity generating power plants can operate as baseload, load-follower or peaking plants depending on the availability of water and on the level of their water reserves. Run-of-the-river hydroelectric plants do not have storage and are therefore used as baseload.

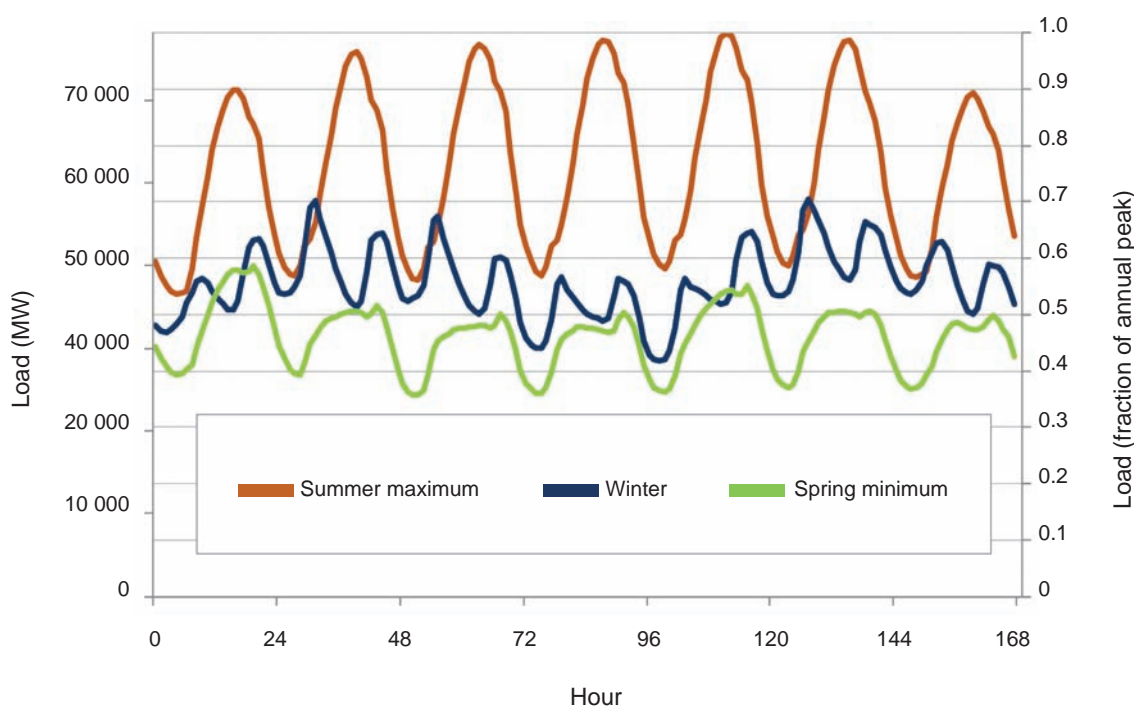
**Figure 2.1: Hourly electricity demand curve in Texas (ERCOT) for 3 weeks in 2005**

Source: Denholm *et al.*, 2010.

The reliability of an electricity generation system refers to its capability to satisfy electricity demand in its area with a very high level of continuity and quality, and encompasses the concepts of security and adequacy. System security is the ability to withstand sudden short-term disturbances such as operational transmission failures, unanticipated losses of generating units, changes in load conditions and other contingencies, as well as human errors. System adequacy comprises both the ability of generating the power required by customers (referred to as generating adequacy) and that of transporting the energy to the actual customer load points (transmitting adequacy). The crucial burden on a local electricity generation system is to cope with variation of demand and to meet peak demand (often referred to as “peak load”).

### Supply and demand balance

Electric power has the characteristic that it travels at the speed of light, meaning that the time constants involved are very small compared to those applicable to other energy carriers, and that it cannot (yet) be economically and easily stored in large quantities. For those reasons it is of fundamental importance that the supply of electric power adjusts almost instantaneously to match changes in demand. The absence of large storage and the resulting need for second-by-second balancing of demand and supply renders the integration of large shares of variable renewables, as envisaged in several OECD countries, particularly tricky. This concerns both the short-term balancing challenge as well as the long-term challenge to maintain adequate capacity in the electrical system at all times.

Grid frequency variation is the direct result of imbalance between generation and load: the grid frequency increases if generation exceeds load and tends to decrease (droop) if load exceeds generation. This imbalance may be the result of an unexpected fault, such as the shutdown of a power plant or transmission line, a sudden loss of a load, or of an error in predicting fluctuating demand and supply from variable generators.

The TSO must ensure that a particular frequency, either 50 or 60 Hz, is maintained within a small tolerance, typically  $\pm 1\%$ . Frequency stability is important in order to assure the correct functioning of all electrical equipment and processes. Large frequency variations can damage some electricity equipment

both on the production and the load side.<sup>5</sup> The balance between demand and supply must be ensured within a particular geographical region, also called “control area” or “balancing area”, which may be isolated geographically, connected to other areas by direct current (DC) interconnections or be an inter-linked part of a common grid. Matching supply and demand must be assured at different time frames: maintaining frequency and voltage stability on the timescale from milliseconds to hours, balancing larger demand and supply fluctuations on a day or weekly base and ensuring that the system is adequate to meet the peak demand occurring only on a year timescale.

Figure 2.2 shows the morning ramp-up from 7 to 10 a.m. in a United States region, decomposed into load following (orange) and frequency regulation (blue). In this utility system the morning load increases smoothly over the course of 2 hours by 400 MW (or 12%), but includes rapid short-term ramps of  $\pm 50$  MW.

**Figure 2.2: System load following and frequency regulation**

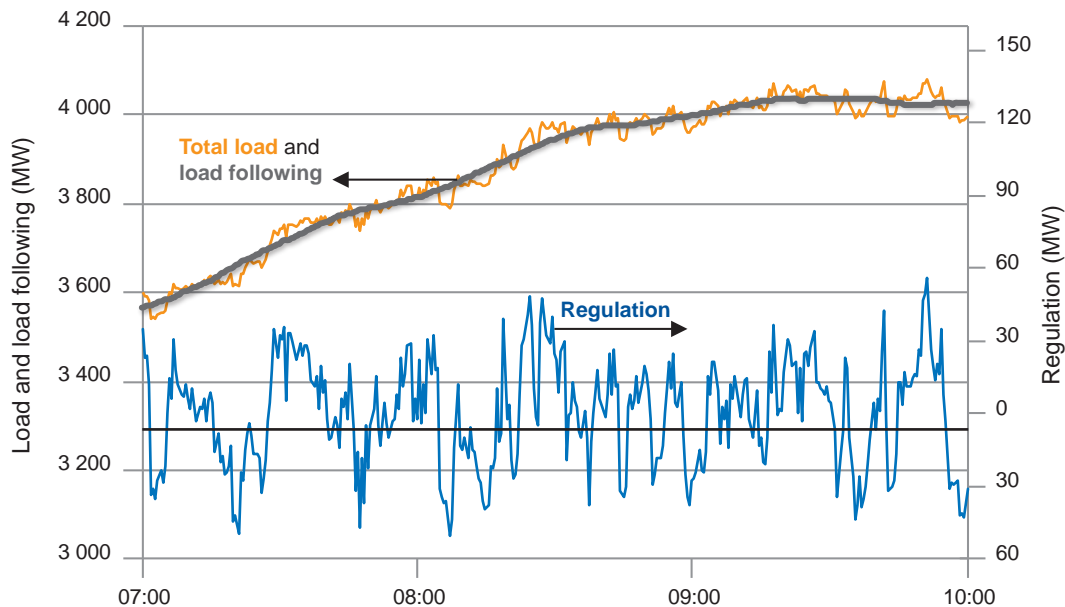

Note: Electricity load curve, morning ramp-up.

Source: Kirby, 2004 (courtesy of the Oak Ridge National Laboratory, US Department of Energy).

### Short-term balancing – system security

TSOs correct frequency variations by adjusting the level of power supply to the load: flexible or dispatchable reserve generation capacity is constantly available to be activated or deactivated automatically or in response to a signal from the TSO. Some OECD countries may have a different mechanism or use a different terminology, but the principle is common to all TSOs.

Whenever an imbalance is detected, the system of generators (with the help of the interconnecting grid) must adjust its output power level in a timely manner to bring the system frequency back within the required window of operation. Frequency containment reserves are operating reserves necessary for constant containment of frequency deviations (fluctuations) from nominal value in order to constantly maintain the power balance in the whole synchronously interconnected system.<sup>6</sup> Activation of these reserves results in a restored power balance at a frequency deviating from nominal value. This

5. A frequency variation of more than 2-4 Hz may cause the disconnection of most generating units.

6. To avoid continue action of the primary control, a dead-band of  $\pm 20$  mHz is used in the European grid.



category includes operating reserves with an activation time typically of 30 seconds. Operating reserves of this category are usually activated automatically and locally. In a period between 30 seconds to a few minutes, the frequency restoration reserves intervene for restoring the frequency to nominal value and freeing primary reserves. On a longer term, replacement reserves are used to restore the required level of operating reserves to be prepared for a further system imbalance. This category includes operating reserves with activation time from 15 minutes up to several hours.

Reserves to maintain frequency (also called primary reserves or frequency containment reserves) consist of plants that operate at less than their full capacity and maintain the possibility of increasing (or decreasing) output. These plants are operated in a frequency sensitive mode, which will result in active power output changes, in response to a change in system frequency, to recover the target frequency. Reserves, regulated by balancing markets, play their role as part of the “solidarity principle” within the whole interconnected area (with many control areas combined)<sup>7</sup> and participate in the primary adjustment, regardless of the area where the fault originated. The Union for the Coordination of the Transmission of Electricity (UCTE) recommends a primary control reserve margin of about 2.5% of the total installed capacity in an electricity generation system and that primary reserves are distributed homogeneously over the synchronous area.

Adjustments through primary reserves ensure that frequency deviations remain within narrow bands both inside a given balancing area and in power interchanges between balancing areas.<sup>8</sup> In the case that frequency exceeds the permissible limits, additional measures or demand reduction, such as automatic “load shedding”, are required and carried out in order to reduce the imbalance and maintain interconnected operation.

Frequency restoration reserves are activated in the balancing area where the imbalance appeared with the objective of re-establishing the nominal grid frequency in the synchronous interconnected area and the power exchanges agreed between control areas. The national grid operator sends all plants participating in secondary frequency control a signal to modify their power output within a previously agreed range. Secondary reserves are operating power plants that can increase power output at a sufficiently rapid pace, on the order of several tens of MW/minute. Hydro (pumping) storage units and quick-start open gas turbines can also be used for this purpose. With the deployment of secondary reserves, primary units can go back to their starting point in order to be able to absorb the next disturbance. The TSO evaluates the need for secondary reserves based on the forecasted variability and level of electricity demand.

Replacement reserves are dispatched on a longer time frame, from 30 minutes to some hours, with the objective to restore secondary reserves and to re-optimize power generation from an economic viewpoint. More economical plants are progressively activated or the output of load following plants is adjusted to replace the units that participated in the secondary reserve, and grid loss is minimised by re-dispatching power generators.

Figure 2.3 illustrates an example of frequency transient due to the sudden disconnection of a power plant and consequent deployment of power reserves. In this example a sudden disconnection of a large power plant leads to an active power shortage, giving rise to gradually decreasing system frequency. Immediately after the disconnection and despite the power imbalance, the inertia present in the kinetic energy of all the rotors acts as a damping mechanism, avoiding a sudden drop in the frequency. Almost immediately primary reserves kick in. When the power balance is restored, the frequency decrease comes to a halt, but for a while, more power needs to be injected to increase the frequency. All this happens on a timescale of seconds. After some minutes, secondary reserves are used, to allow the primary units to go back to their starting point (to be able to absorb the next disturbance). These units bring the frequency back to the equilibrium level and guarantee that the control area itself returns to a power balance. Finally, tertiary reserves (long-term reserves on the illustration) progressively replace the secondary reserves.

7. In Europe, it is the whole of the synchronised interconnected system that participates.

8. The frequency deviation from nominal values depends, among other factors, on the size of the synchronous interconnected system: the frequency drop is lower for larger systems.

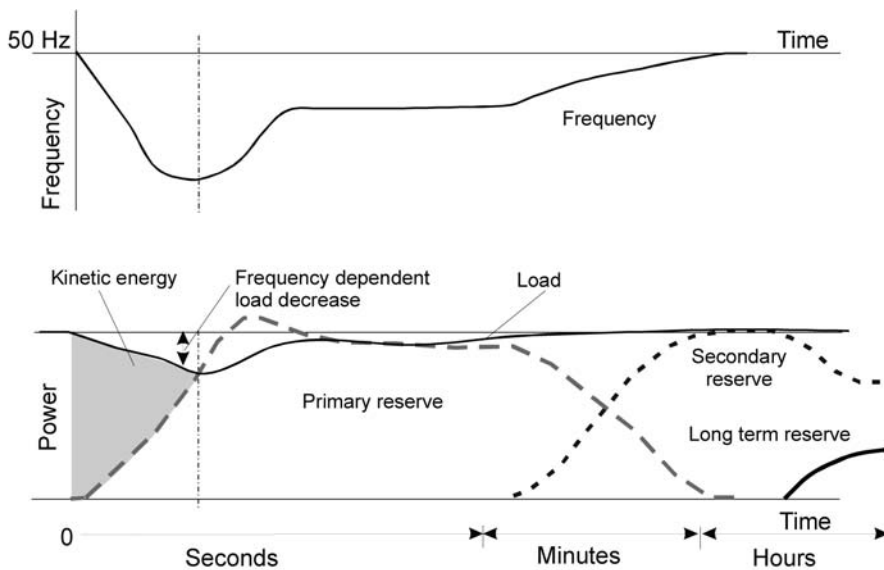
**Figure 2.3: Activation of power reserves in the event of the disconnection of a large plant**

Source: Hirvonen, 2000.

In general, there are services other than frequency control needed to ensure the reliability of the electrical power system. EURELECTRIC classifies (EURELECTRIC, 2004) as ancillary services “all services required by the transmission or distribution system operator to enable them to maintain the integrity and stability of the transmission or distribution system as well as the power quality”. Ancillary services comprise frequency control, voltage control, spinning reserve, standing reserve, black start capacity, remote automatic generation control, grid loss compensation and emergency control actions.

#### *Long-term balance – system adequacy*

Adequacy is the ability of an electrical power system to satisfy demand at all times, taking into account the fluctuations of demand and supply, reasonably expected outages of system components, the projected retiring of generating facilities and so forth. Adequacy is related to the long run characteristics of an electrical system. In the last decade the long-term adequacy of the electrical system has been becoming an issue in many OECD countries due to a progressive slow-down in the investments in new dispatchable capacity, a growth in peak demand and increasing doubts about the ability of variable renewables to contribute to long-term system adequacy.

Adequacy analysis is traditionally conducted in a deterministic way, taking into account, for each generating plant, only the fraction of power that is reliably available to cover the load at each reference point. The reliably available capacity takes into account the average availability of the power plant due to outages and maintenance shutdowns, the limitations to power output due to natural conditions (such as wind speed and direction, water temperature, precipitation and the solar irradiation factor) as well as the reserve capacity used for short-term balancing. An additional margin should be kept available to take into account the stochastic variations in component failures, meteorological conditions and all parameters affecting production and load estimates. This margin, often referred as “spare capacity” depends on the size of the system, the composition of the generating portfolio and on the assumed probability of loss of load. In UCTE a spare capacity of 5-10% of the total generation capacity is considered sufficient to ensure the security of supply on 99% of the situations; in the United Kingdom a margin of 12 to 14 GW (corresponding to about 20% of the capacity) is assumed.

Depending on the size of the system and the composition of the generating portfolio, Figure 2.4 shows the theoretical reserve margin versus the real margin for all European countries in 2010. This real reserve margin does not take into account contracted import.

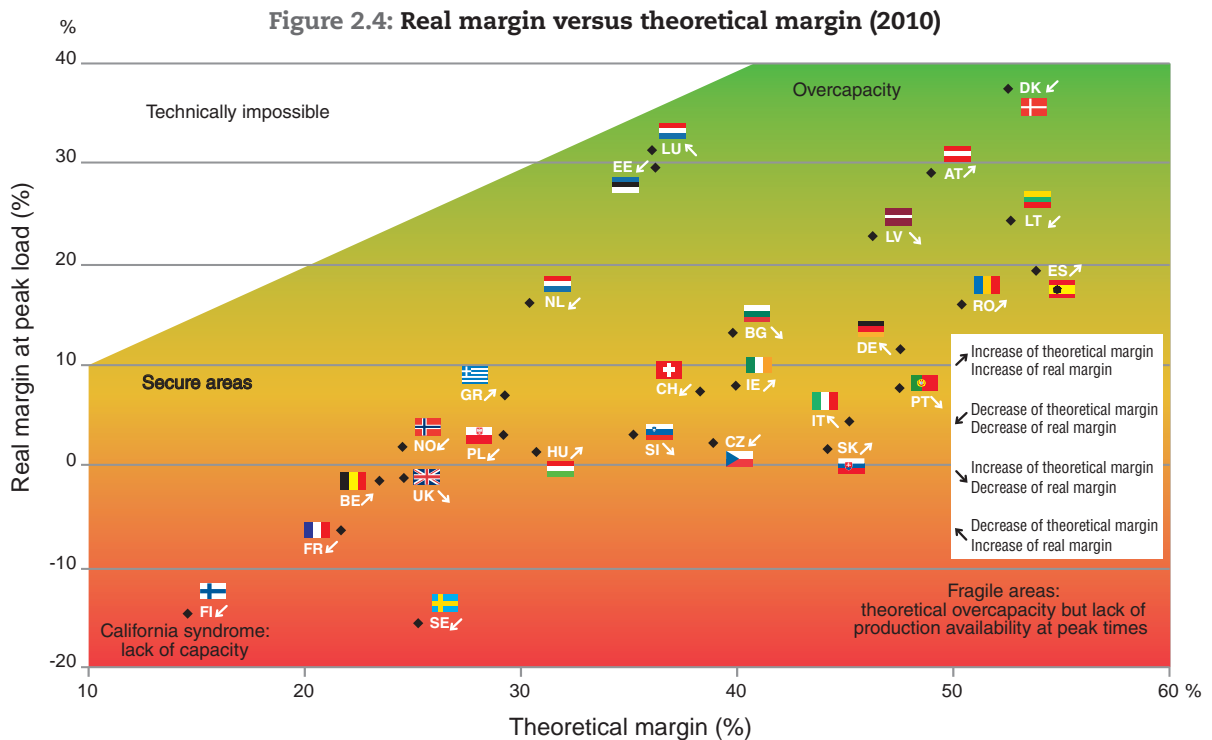

Source: Capgemini, 2010.

Concerning adequate generation capacity, it is important to introduce the concept usually designated as “capacity credit” of variable sources. It is often argued that the installation of 1 GW wind requires 1 GW of (flexible) back-up capacity, because, the reasoning goes, there are moments when there is no wind. This is not correct from a systems point of view. Indeed, because conventional power plants of the generation system also have a reliability that is lower than 100%, e.g. 90%, about 10% of the time, such plants are not always available when needed, especially in the event of unexpected outages caused by technical problems. To find the right amount of necessary secure power capacity to “back up” the variable wind-power source, the system concept of loss of load probability (LOLP) is relied upon, referring to the probability that the system cannot meet its peak load. The capacity credit of variable sources is defined as the equivalent of conventional generation that the variable generating source represents to guarantee the same overall system security or LOLP.

For instance, in the example above, if for the same system demand (or load) 1 000 MW of installed wind capacity effectively replaces 200 MW of common power plants, allowing 200 MW of dispatchable electricity to be decommissioned, then the capacity credit is said to be 20%. Equivalently, if system peak demand were to increase by 1 000 MW and 1 000 MW of wind power were installed to help meet that load increase, but 800 MW of conventional power plants is still needed for “back up” and balancing assistance, then the capacity credit would also be 20%. The capacity credit is dependent on the composition of the underlying electricity generation system, the grid structure and on the amount of wind power concerned. For low wind penetration, the capacity credit can be approximated by the capacity factor; for larger wind injections, the capacity credit decreases with increasing wind power capacity, and this decrease goes faster for small regions.

### Basic requirements on generators

Unexpected variations in electricity demand and supply and faults on power generators and transmission lines are inevitable and common events in an electrical system. The consequent variations and disturbances on the grid voltage and frequency are experienced daily by power generators and electricity end users. In order to ensure the stability of the electrical system, the TSO requires that all generating

units are able to assist the control of voltage and frequency and are able to withstand certain frequency and voltage variations. Each TSO publishes, in a document called “Grid Code”, the performances that each generating unit must meet to be connected to the system.

Generating units are required to be capable of operating at full power indefinitely in the case of limited variations of frequency and voltage (typical values are a variation of  $\pm 1\%$  in frequency and of  $\pm 5\%$  in voltage). Also, generating plants should be able to ride through certain transient events in the transmission system without tripping, such as a sudden step change in the voltage; a typical requirement is a voltage step of  $\pm 6\%$ . Other requirements exist for continued operation for a limited time, eventually at a reduced power rate, for a broader range of voltage and frequency conditions (up to  $\pm 5\%$  in frequency and  $\pm 10\%$  in voltage) that are supposed to occur only on a few occasions per year. All generating units should be able to provide a specific range on reactive power to assist control of the system voltage. Finally, it should be noted that extremes of grid voltage could occur at the same time as extremes of grid frequency (in particular low voltage together with low frequency); generating plants should be designed to meet these extremes simultaneously. Other requirements that a TSO may impose on generators are the ability to operate in a frequency regulation mode, to follow the load with a minimal ramp rate and to trip to “house load operations” for specific grid circumstances.

These requirements depend on the size and the characteristics of the electrical grid, and may also be a function of the size and the type of generating unit. For most grid systems these requirements encompass the full range of variation of grid voltage that is possible without voltage collapse (brownout). As an example, Figure 2.5 illustrates the frequency/voltage requirements on generating units set in the NORDEL grid code.

**Figure 2.5: Illustration of frequency and voltage operating limits based on NORDEL grid code**

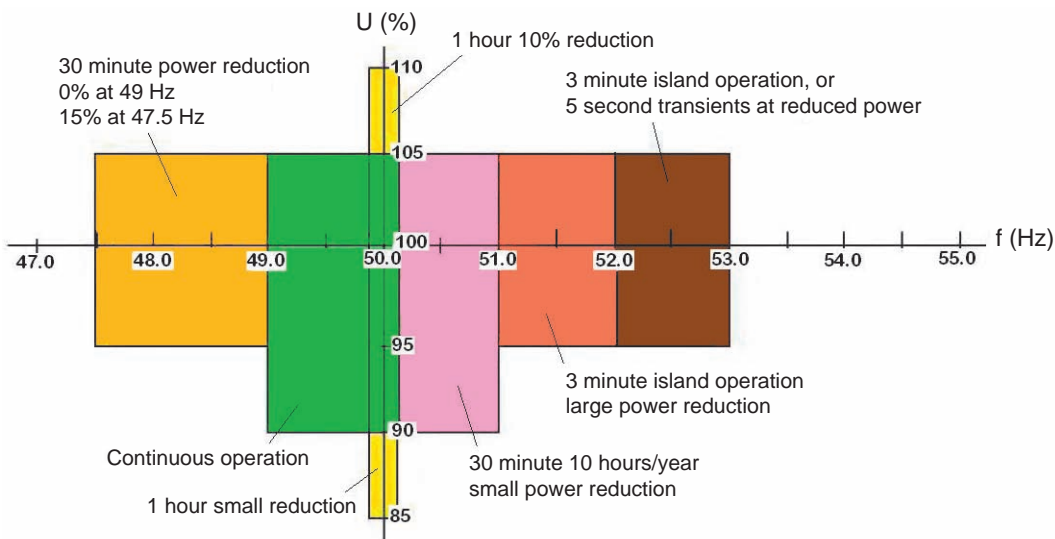

Source: NEA, 2009.

## 2.2 The siting issue<sup>9</sup>

Due to the safety concerns and potential consequences of a nuclear accident on the population and the environment, the requirements and criteria for siting a nuclear power plant are generally more stringent than those for other generating plants. First, the general requirements and criteria for siting any power plant will be analysed. Then, the technical and safety requirements specific to nuclear power plants will be described, as well as their economical effects on the nuclear plant developer and on the whole electrical system.

9. Main references for this section are IAEA (2003) and IAEA (2004a).

The location of a new large industrial facility such as a power plant is a complex task involving the plant developer, the TSO, public authorities at the national and/or regional level as well as the population residing in the vicinity of the installation. Especially in OECD countries, a strong opposition to large thermal power plants (and in particular to nuclear power plants) and the not-in-my-back-yard (NIMBY) syndrome have undermined or slowed down the planning, construction and grid connection of new generating capacity. Undoubtedly, wide public support or acceptance of the project and appropriate co-ordination with all stakeholders are key elements to its successful and timely completion. Beside this aspect, which is somehow beyond the scope of the present study, a number of technical, environmental, safety, social and economical issues must be considered and addressed in the siting process of any power plant. Most of these issues and criteria are common to all electricity generating technologies. However, each generating source has its own needs and peculiarities and some aspects might be more relevant than others. In the next paragraphs some issues that are common to any generating technologies are identified; later the aspects specific to nuclear energy will be developed.

Technical-economical criteria encompass a variety of considerations such as the size and cost of the required land, the geological characteristics of the soil, the accessibility of the site and the existence of an efficient transport infrastructure, the distance from the existing transmission grid and large load centres and, in the case of thermal power plants, the presence of an adequate cooling source.

Large thermal power plants require a large free surface, of several tens of hectares, and impose more stringent criteria in term of soil homogeneity and resistance in order to cope with the heavy loads of power plant structures. On the other hand, thermal, and particularly nuclear plants, have a very high energy density compared to other generating sources.<sup>10</sup> Thus, for the same capacity or electrical output, the land surface required is considerably smaller. An additional siting requirement for thermal power plants is the presence of a sufficient and reliable cooling source in the immediate vicinity of the installation. This need is particularly important for those units with large electricity output and lower thermal conversion efficiency, such as nuclear and coal.

The existence of an efficient transport system is also an important criterion for siting power plants. During the construction, large and heavy equipment have to be moved to the power plant site, and adequate transport capability (by train and by road) must be available. Proximity to a cheap transport system is important for fossil fuelled plants, and particularly for coal, since the cost for fuel transport and for removal of ashes and other residuals from combustion can be significant.

From a grid integration viewpoint, a power plant needs to be close to a major load centre and to appropriate existing transmission infrastructure. This reduces both connection costs and the need for costly grid reinforcements. Also, this would minimise transmission losses and reduce the complexity of the grid, which would benefit the operational efficiency and reliability of the whole electrical system. There are, however, many arguments that favour locating a power plant in more remote and less densely populated areas, including economical considerations, environmental issues and safety criteria. Therefore large power plants are rarely located in the vicinity of major load centres, which are generally densely populated.

Environmental issues include the impact that the power plant has on the surrounding areas during construction, operation and dismantling. Environmental aspects encompass the quality of air and the water as well as the impact of the power plant on the wildlife and surrounding nature. Emissions of pollutants into the atmosphere are a concern mainly for fossil-fuelled power plants. Pollutants, namely sulphur dioxide (SO<sub>2</sub>), nitrogen oxides (NO<sub>x</sub>) and particulates, are generated in the combustion process by impurities present in the fuel. The highest level of emissions comes from coal and oil-fired plants. Thermal emissions both to the air and to the cooling source are associated with any thermal power plant, fossil-fuelled or nuclear. Several OECD countries have set limits to the temperature increase of the water used for cooling, which may pose an additional constraint when siting a thermal power plant.

10. The energy density for a nuclear power plant is of about 1÷4 kW/m<sup>2</sup>, depending on the number and the size of units at the same site.

Finally, safety considerations and measures to protect public health are also important in determining the appropriate location of a power plant. The selected site should allow safe operation of the power plant and minimise the consequences of potential accidents, such as natural gas explosions, radioactive releases and chemical spills, on the plant workers and the general population. A generally accepted rule is to locate large generating units in remote areas and away from major cities in order to minimise the consequences of an accident and to ease evacuation operations.

### **Box 2.1**

#### **Location signals: trade-off between electricity and fuel transport costs in Germany.<sup>11</sup> Issues in siting power plants: fuel vs. electricity transport costs**

Since primary energy resources are usually located far from populated areas and main load centres, their exploitation requires the transmission of electricity over long distances or the equivalent transportation of primary resources. The cost of transporting primary resources depends on, among others, according to the type of resource; the transport system chosen, the distance and the infrastructure already existing as well as the amount of energy to be moved. The choice whether to locate a new power plant close to the load, thus carrying primary energy over long distances, or close to the energy source, thus transporting electricity over long distances, should take into account the total costs for the whole electricity system, as well as other externalities related to transport costs.

The liberalisation of the electricity sector, with the increase of participants in the electricity market and the effective separation between generation and transmission/distribution networks (unbundling) has created some difficulties and issues for the optimal design of the electrical system. Under traditional planning, a vertically integrated company could decide simultaneously about network expansion and location of new generating plants. This would allow, in theory, for an optimal allocation of the resources and the achievement of a cost-effective system planning. Under unbundling, the TSO and the power plant developers plan independently of each other, and in general, the plant developer is not directly exposed to the network expansion costs induced by the construction of the new power plant. Those costs are thus not taken into account in the investment decision, and the choice of the power plant location might not reflect the impact on the whole system. This could lead to a suboptimal allocation of resources if appropriate signals are not given to all market participants.

In Germany, most of the primary resources used for electricity production are imported. Hard coal is shipped to the ports in the North Sea, while natural gas is imported from the Russian Federation, the Netherlands and Norway via pipelines, entering Germany at the East and North-West borders. The electricity load is mainly concentrated in the industrial region along the Rhine and Main along the Western border of Germany and in the Munich region, in the South of Germany. In recent years, electricity generation has been concentrating in the Northern part of the country, thus increasing the congestion in the North-South electricity transmission network. This trend is the result of three different factors: i) the decommissioning of power plants in the central and southern part of the country; ii) a tendency to locate new fossil-fuelled power plants close to the primary energy sources; and iii) the development of wind energy taking advantage of favourable conditions.

A macroeconomic comparison of costs between electricity and fuel transport costs shows that, in Germany, siting gas-fuelled and nuclear power plants near the load centres allows minimising total cost for the whole electrical system. For those technologies, the transport of primary energy is, in principle, less expensive than transmitting electricity regardless of the distance considered. A similar clear-cut conclusion cannot be drawn for coal-fired power plants. Imported coal lands on international ports (Amsterdam/Rotterdam/Antwerp, Hamburg and Bremen) and is carried to the plant via ship or rail. Overall, rail transport is considerably more expensive than transport by ship, which makes the transport costs for hard coal strongly dependent on the geographical location. Hard coal transport costs range from a few euros per tonne for coastal sites close to the delivery ports in the North and Baltic Sea, to about EUR 10/tonne in the areas accessible by inland waterways, mainly along Rhine and Elbe. Coal transport by rail to inland locations is considerably more expensive, between 30 and EUR 50/tonne. New coal-fuelled power plants are almost exclusively located with access to coastal ports on the North or in the inland waterways, reflecting the above mentioned differences in hard coal transport costs. In general, coal transport along the major waterways is a cheaper option than electricity transmission. For a coal-fuelled plant sited inland, macro-economical analysis shows that coal transport is the optimal choice for long distances, while electricity transmission is preferable for shorter distances, up to 300 km. Figure 2.6 shows total transport costs for fuel and electricity in Germany, for gas (orange), coal (grey and green) and electricity.

11. Box 2.1 is based on the report commissioned by the German Federal Ministry for Economics and Technology (BMWi) from Consentec/Frontier Economics (Consentec/Frontier Economics, 2008).

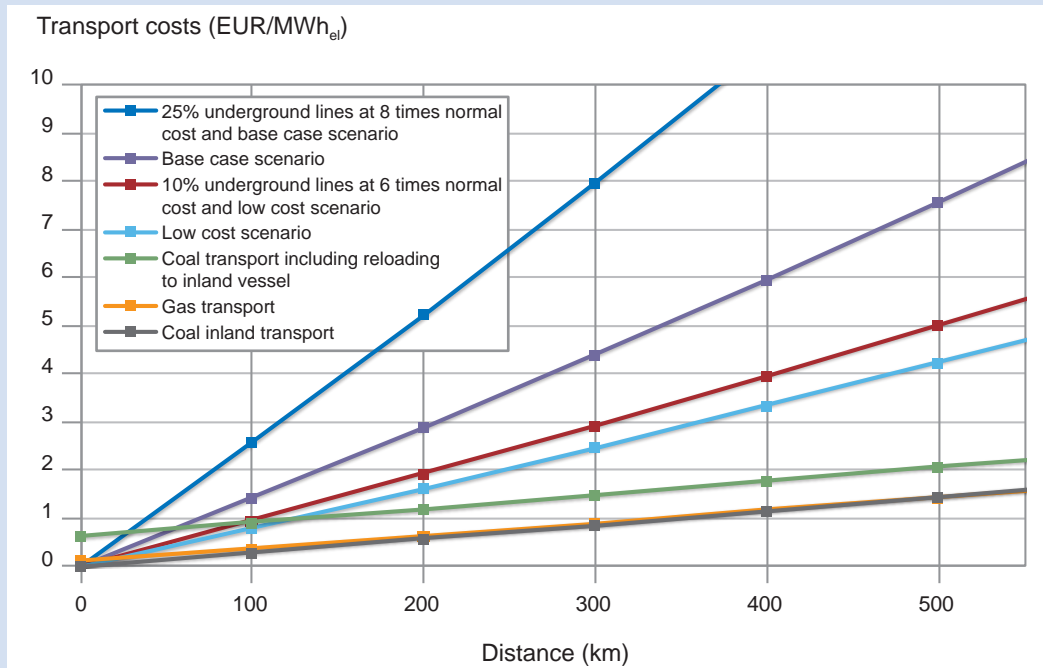
**Figure 2.6: Comparison of the total transport costs for fuel and electricity in Germany**

Source: Consentec/Frontier Economics, 2008, Figure 12, p. 42.

Presently the German electricity market does not have location generating tariffs and electricity transportation costs are fully borne by consumers. With the existing regulatory framework, power plant developers do not have incentives to consider electricity transmission costs in their investment decision and hence locate generators close to primary energy sources. In this context, plant location incentives would improve system planning and allow for a total-cost optimal site selection. This could be obtained with geographical differentiated tariffs or competitive tenders for targeted geographical locations.

### Issues in locating and siting a nuclear power plant

National nuclear safety authorities and international bodies such as the IAEA have established a set of criteria or recommendations for the choice of a nuclear site. The objective is to enhance nuclear safety by reducing the likelihood of a nuclear accident and minimising the consequences on the population. The constraints and requirements on a nuclear site are therefore more stringent than those for any power plants: this affects aspects such as the distance from largely populated areas, the resilience to extreme natural events and the presence of an adequate cooling source.

A first criterion is related to the surface requirements for a nuclear site. According to IAEA evaluations (IAEA, 2012), the standard arrangement of one nuclear unit and its auxiliary buildings covers about 40 ha, and an additional 30 ha are needed for the construction zone. About 10 ha are required for cooling towers, if the unit uses indirect or dry cooling. The same 10 ha surface is required if storage buildings for spent fuel and waste are foreseen on the layout. Finally, an area of about 10 ha is required in the vicinity of the power plant for an outdoor substation. Thus, a nuclear installation of one or two units requires a minimal area of 50-80 ha, depending on cooling method and needs for interim waste storage. The total surface required for a nuclear site with 4 units for a total of 1 450 MW has been estimated as 150 ha in France (Ithier, Brunet and Astolfi, 1998).

### *Population density and proximity to other industrial installations*

Nuclear installations are generally located in sparsely populated areas and away from large population centres. Population distribution, site topography, prevailing wind directions and evacuation possibilities are taken into account in the study evaluating public health consequences during normal operations and in case of an accident. The primary criterion for siting a nuclear power plant is to minimise the radiation dose to the population during normal operation and in the case of a nuclear accident with external release of radioactive material. Also, in the event of a nuclear accident, appropriate siting reduces the size of the population that has to be evacuated and eases the planning and implementation of evacuation measures.

The majority of countries hosting a nuclear power plant prohibit or restrict permanent settlement in a primary zone surrounding the NPP area and require that an evacuation and emergency plan is prepared for those living in outer zones. Some countries require a minimal distance from large urban centres. For example, the Finnish Radiation and Nuclear Safety Authority (STUK, 2000) identifies a zone of about 1 km outside the power plant area where permanent settlement is prohibited. In a second zone of approximately 5 km from the facility, urban development is restricted to prevent large growth in the population. In a third zone of about a 20 km radius, plans for evacuating the resident population must be prepared. Similar requirements are contained in the US Code of Federal Regulation issued by the US Nuclear Regulatory Commission (NRC, 2012): a low population zone and two emergency planning zones are defined, taking into account the potential exposure of the population in case of a postulated fission product release.

For safety reasons, several countries require a minimal distance between nuclear power plants and hazardous facilities, such as chemical industries, gas and oil pipelines, dams, refineries, mining operation zones or transportation corridors for potentially explosive materials. Furthermore, a minimal distance is required from major airport and aerial corridors in order to reduce the risk of an airplane crash into the nuclear containment.

### *Geology and extreme meteorological events*

The potential effects of earthquakes, tsunamis, flooding and other extreme meteorological events such as tornadoes, cyclones and extreme winds on the safe operation of a nuclear power plant must be carefully evaluated and integrated in the site selection process and in the design of the facilities.

Nuclear power plants are designed to withstand earthquakes of a certain magnitude (safe shutdown earthquake, SSE). Earthquakes of magnitude inferior to the SSE should not affect the capability of nuclear units to safely shut down the plant, adequately cool the nuclear fuel and maintain the integrity of the containment barriers. Most safety authorities require the nuclear developer to determine the most severe credible earthquake that could be expected for each specific site, taking into account available information on the local seismology, geological characteristics and historical data. If the most severe credible earthquake exceeds the SSE, the design of the plant and its safety-related equipment need to be adapted accordingly.

Other natural phenomena, such as tornadoes, typhoons, cyclones, flooding and tsunamis could affect the safety of a nuclear installation and must be therefore taken into account in site selection and evaluation. The NPP developer must consider the frequency and potential consequences of these natural phenomena on the safety of the nuclear installation and must adapt the plant design accordingly. Depending on the site, specific protections may be required, including minimal elevation above sea level, construction of additional protective barriers for flooding and tsunamis, and taking special protective measures for some safety-related equipment. All of these site-specific adaptations of the plant design affect the overall investment cost of the plant.

### *Proximity to adequate cooling sources*

Almost all nuclear power plants in the world are located in the vicinity of a water source which ensures adequate cooling during normal operations of the plant. Nuclear energy shares the need of a heat sink with all fossil-fuelled generating sources. However, the water source has two additional functions for nuclear power. Firstly, an adequate water reserve is needed to cool down the fuel in accidental situations. Secondly, water is used for volume control of chemical and radiological liquid wastes produced during normal operation.



The need of a heat sink is inherent with any steam-cycle system, since only a fraction of thermal energy can be converted into electricity, the remaining being discharged to the environment. Nuclear power plants currently being built have a thermal efficiency of about 34-36%,<sup>12</sup> while modern coal-fired power plants achieve almost 40% and combined cycle gas turbine (CCGT) plants reach 60% thermal efficiency. Higher thermal efficiency means not only a reduced cooling requirement but also more electricity for a given amount of fuel. As an example, according to a French government study, siting an EPR near a river reduces the electricity output by 0.9% with respect to a location near the sea. Siting the planned new Turkish nuclear project on its Black Sea rather than on its Mediterranean coast would allow for a 1% gain in electrical output since average water temperatures in the Black sea are about 5 °C lower.

Several cooling methods are possible for an NPP: once-through cooling, re-circulating wet cooling and dry cooling. Nuclear power plants sited in the vicinity of a large source of water, either a sea, lake or river, are generally cooled by running a large amount of water into the condenser and discharging it back to the original source a few degrees warmer, with little or no evaporation. This is known as once-through cooling. The water withdrawal requirements for a nuclear power plant of 1 GW employing this cooling method are about 50 m<sup>3</sup>/s, which corresponds to 1.3 billion tonnes of water per year. If the water availability is limited, heat removal is generally accomplished via evaporation in cooling towers with a re-circulating system: water passes through the condenser, is pumped to the top of the tower and is sprayed downwards to a collection basin, while being cooled by an up-draught of air. In a wet re-circulating system, about 4-5% of the water evaporates and must be replaced. The water lost by evaporation is about 1.75-2.5 litres per kWh, which corresponds to about 15 million tonnes per year for a nuclear power plant of 1 GW. Finally, dry cooling mechanisms allow for locating NPP away from abundant water sources: excess heat is transferred to the air via a forced draught through a finned structure.

Once-through cooling is the simplest and cheapest cooling method. In order to avoid disturbance to existing wildlife, national regulations impose limits on the temperature of returned water and/or on the temperature increase between inlet and outlet. The permitted temperature increase is usually in the range of 1.5-3 °C, and maximal water temperature at the outlet should be less than about 30 °C. Adverse weather conditions, such as unusually high water temperature, might require reduction of the electrical output of the NPP, due to reaching the limits of outlet water temperature. Very hot summer conditions caused the power reduction of several American, French, German and nuclear power plants during the summer of 2010. Limits on thermal dilution are less constrained if sea water is used for cooling. In addition, sea water temperature is less variable during the year, and generally a few degrees lower than that of the rivers, which allows for greater electrical efficiency. However, in this case higher grade materials must be employed to prevent corrosion, which increases investment costs for the NPP.

A study from the DOE (DOE, 2009) estimates that cooling system investment costs for re-circulating cooling are about 40% higher than those for once-through cooling. In addition, a recirculating system with cooling towers reduces the efficiency of a nuclear power plant by 2-5% relative to once-through cooling. Investment requirements and reduction of overall plant efficiency are even greater if dry cooling is adopted: the estimated cooling system investment costs of dry cooling are about 3-4 times higher than those for wet cooling.

In a nuclear power plant, a reserve of water is needed to ensure the removal of residual heat and adequate fuel cooling when the plant is shut down and in all accidental situations. For essential service water, the system must be capable of cooling the plant under the worst conditions for 30 days, with a minimal flow rate of 1 m<sup>3</sup>/s. With an open circuit, a water reserve of 3 million m<sup>3</sup> should be available.

Potential chemical releases of NPPs are mainly boric acid, lithium, hydrazine, morpholine, ethanolamine and phosphates. Other chemical waste is produced by the demineralisation plant, the laundry and cooling water treatment (monochloramine, sulfuric acid, chlorine), depending on the characteristics of the raw water. The acceptability of liquid waste releases should be considered from both a health and an environmental point of view. Thresholds of chemical releases are defined by local regulations, generally on an annual (average) or daily (peak) basis. Radiological liquid wastes of an NPP are tritium, boron, iodine and other beta and gamma emitters. French national regulations, for example, limits the

12. Thermal efficiency depends mainly on the temperature difference between the internal heat source and the external heat sink.

activity added into a river to a daily value of 100 Bq/l for tritium release. The daily limit for iodine release is set to 0.1 Bq/l, and 0.7 Bq/l is the maximum for all other isotopes. For sea water, the limit of the daily average concentration in the cooling water is defined as 800 Bq/l for tritium, 1 Bq/l for iodine and 7 Bq/l for all other isotopes, after complete dilution in the cooling water flow. The most restrictive requirement is the tritium release when the plant is cooled by a river.

Locating a nuclear power plant is a more complex and time consuming process than for any other generating technology. The specific characteristics of nuclear energy pose more stringent geological requirements to potential locations, and the procedure needed to identify, evaluate, compare and select a site is particularly complex and time consuming. Additional engineering safeguards and adaptations of the original plant design are often necessary when unfavourable physical characteristics of the site exist. Additional time and investment costs for site selection have an economical impact on the project. These extra costs, however, are almost fully borne by the nuclear power plant developer as additional investment costs and overall plant efficiency reduction. Thus these costs are mostly internalised at the plant level. Thus, as an initial estimate, the system costs related to location issues are quite limited for nuclear.

### 2.3 The importance of grid quality for nuclear power plants<sup>13</sup>

Nuclear power plants have several similarities to fossil-fuel power plants. All thermal power plants are based on the same principle (converting heat into mechanical and electrical energy) and all share similar needs for a heat sink and cooling requirements. Hence, several important components of the plants are similar, such as the steam turbine, the generator and the large power transformers. All thermal plants also require a stable supply of electric power during normal operations, to operate control and surveillance systems, start and control pumps and valves, and support operator information systems to control the plant. Electricity is also needed when the plant is shut down, to support maintenance work, operate various equipment and restart the power plant.

However, a key aspect that differentiates nuclear power plants from other thermal generators, and that ultimately makes its integration into the electrical system more delicate, is the major role that a stable electrical supply plays in the safety of the installation. Electricity is required to operate most of the safety functions of a nuclear power plant: monitoring and adjusting the reactivity, removing heat from the core, confining radioactive materials, controlling operational discharges and limiting accidental releases. In particular, a stable and reliable source of external electric power is essential for ensuring appropriate cooling of the fuel during planned shutdown or in accident and post-accident transients.<sup>14</sup> The prolonged unavailability of offsite external power and the failure of onsite emergency generators were the main contributors to the damage sustained by the three units at Fukushima Daiichi following the earthquake in 2011.

The integration of a nuclear power plant into an electrical system imposes specific constraints and more stringent requirements on the design, stability and availability of the electric grid. Some of these are solely related to the large size of the new commercial nuclear units and would be equivalent for any power plant of a comparable size. However, most are in relation to the essential role that the electrical system plays in the safety of nuclear power plants. In particular, nuclear poses additional requirements in terms of grid control, monitoring and operations. The integration of a nuclear power plant into an electrical system is therefore likely to require development, strengthening and upgrade of the electrical grid, which would require additional investments from the grid operator. Those additional investments might be significant, especially for countries that do not yet have any nuclear unit and are developing

13. This section benefited greatly from the substantial contributions by Philippe Lebreton, EDF.

14. At shutdown, the nuclear chain reaction is immediately stopped and no more energy is directly produced by fission. However, the nuclear fuel continues to generate heat due to the decay of fission products accumulated in the fuel. The amount of decay heat and its evolution with time depends on the average fuel burn-up, the type of fuel and the operating history of the plant. Immediately after shutdown, the decay heat ranges between 6.5% and 7.5% of thermal power and decreases with time following an exponential law (10 days after shutdown the residual power is less than 0.5% of the nominal value). For a 1 000 MWe plant, the decay heat ranges between 200 and 220 MW (thermal) at shutdown.

nuclear power. Countries with existing nuclear power generally have an electrical infrastructure of good quality and already adapted to nuclear needs; in those cases the required grid upgrades and associated investments tend to be more limited.

### **Aspects proper to nuclear power plants**

The major aspects that differentiate nuclear from other generating sources (size, additional connection needs, electrical grid requirements and operational characteristics) will now be discussed. The next section will analyse the potential consequences of grid disturbances on the safety and operations of nuclear plants. Estimation of costs related to the integration of nuclear power into the grid is examined in the following section.

#### *The size of a nuclear power plant and its impact on grid design*

Integrating a large power unit into an electrical system poses some challenges to the transmission system operator, regardless of the type of power plant. The TSO must ensure that the electrical system has sufficient capacity to control and limit the changes in frequency, voltage and power flow that occur following a transmission line disconnection or the trip of a generating unit. The reserve needed to ensure the stability of the electrical system depends on the size of the largest or two largest units. Also, the system must meet electricity demand and provide sufficient reserve capacity when the largest unit is disconnected from the grid during planned or unplanned outages. A generally accepted rule is that the capacity of the largest generating unit should be limited to 10% of the minimal power demand in the system. From the nuclear safety viewpoint, it is necessary that an unexpected trip of the nuclear unit would not cause an inability of the electrical system to provide “offsite” capacity for safety equipment.

These constraints can be limiting for locating new nuclear power plants, which have an electrical output of 1 000-1 600 MW, and are most likely the largest generating units in the balancing area. Siting a nuclear power plant may be particularly challenging when the power demand of a country is relatively low, as is often the case for the very first nuclear reactor in a given area. Increasing the size of interconnected areas can be an effective solution to improve the stability of the grid, therefore allowing the construction of larger generating units. Also, the possibility of automatically disconnecting some predetermined load in case of a nuclear plant trip can ease considerably the integration of a large nuclear power plant into a relatively small grid. An example is the integration of a large EPR unit (about 1 630 MW) in Olkiluoto, which is significantly larger than any other power plant in Finland (the largest being a nuclear power plant of 860 MW) and the connected Nordic system (the largest being a 1 170 MW NPP in Forsmark, Sweden). About 300-400 MW of industrial load is automatically disconnected from the grid if the reactor trips. In that way, a plant of 1 600 MW is “seen” by the grid as one of only 1 300 MW, which is not much larger than the largest plant in the whole connected Nordic system.

#### *Grid connection*

Probabilistic safety analysis has shown that the loss of offsite electrical power is one of the major initiating events that could lead to significant core damages. As seen during the Fukushima Daiichi accident, the loss of all electrical supply led to significant damage to the nuclear fuel within a few hours, and ultimately to an extensive core melt. Thus, the reliability of power supply has always been a focus of safety engineering and assessment.

Under normal conditions, the electrical supply of a nuclear power plant is guaranteed by the external electrical grid, referred as “offsite” power supply. This is the most stable and reliable source of electricity for a nuclear power plant and is therefore the preferred source during normal operations or when the nuclear unit is shut down. In case of its unavailability, a portion of the high voltage power generated by the plant’s main generator is fed back through unit auxiliary transformers to supply all normal house loads.<sup>15</sup> If both systems fail, the plant is equipped with onsite emergency back-up capacities, which constitute the third level of protection of the AC electrical system. These sources, such as diesel generators, batteries or gas turbines, can be operational within a few minutes and are designed to withstand external events considered in the design bases of the plant.

15. The full electrical load of the NPP auxiliaries typically represents 5-8% of the rated power.

The connection with the transmission grid is ensured by at least two physically independent transmission circuits in order to minimise the likelihood of their simultaneous failure. The main connection is the one used for export of power from the NPP generator to the main grid. For large nuclear units, a line of generally 400 kV connects the step-up transformers to the first power substation. The second connection provides a supply to the NPP via the station transformer if the main connection is not available. The voltage of the second line varies between 110 kV to 400 kV, depending on the short circuit power required when switching from normal to auxiliary. The connections to the generator transformer and station transformer(s) should be designed in such a manner that one fault cannot render all connections inoperable. A reliable offsite supply also requires a sufficient number of transmission circuit connections from the local substation or substations to the rest of the transmission system, and measures to ensure the substations and transmission circuits are sufficiently robust to withstand extreme events such as hurricanes, tornados, earthquakes or flooding.

### *Grid power quality and reliability*

Nuclear power plants have also stringent requirements on electrical grid availability and on voltage and frequency stability in order to minimise shutdown caused by problems with the grid system. Grid voltage and frequency instabilities can have an impact on NPP operations: transients originating in the grid lead to transients in the NPP in a chainlike fashion, the effect of which, depending upon the severity of the disturbance, may lead to a transient in the electricity output, the isolating of the NPP or even the tripping of the reactor. Conversely, a nuclear unit trip can cause a grid disturbance resulting in severe degradation of the grid voltage and frequency, or even to power grid collapse. The interactions between the grid and nuclear power plants will be discussed in greater detail in the following section.

### *Operational characteristics*

From an operational viewpoint, nuclear power plants have some specific characteristics that can contribute significantly to the quality and stability of electrical power, and are therefore extremely valuable to the TSO. Because of their large turbo generators, with substantial inertia, nuclear power plants increase significantly the overall inertia of the electrical system thus providing some insurance against sudden disturbances.<sup>16</sup> An electrical system with higher inertia will experience a slower change in frequency for a given mismatch in the demand and supply of electricity. With their high inertia, large reactive power and dynamic stability, nuclear power plants contribute significantly to grid stability for frequency, voltage and angle.

The strong predictability and high reliability of the power generation from nuclear plants are also important for the TSO. Generally, the operational schedule of an NPP is known significantly in advance by the TSO, thus easing the planning and scheduling for the whole electrical production system. Also, nuclear power plants are extremely reliable, with a very small unexpected outage rate (typically less than 0.5 trips per reactor-year in France) which reduces significantly the needs for balancing and the associated costs.

Finally, nuclear power plants are very resilient to transitory hazards affecting the electricity system. In most cases, the nuclear system is able to continue producing power at a reduced level and feed the onsite electric support system. As such, nuclear power plants are important contributors to grid restoration in the event of blackouts.

Despite good technical load following abilities, nuclear power plants often have more constrained operating schedules, which can make them less flexible to respond to TSO needs than other dispatchable generating technologies. In particular, NPPs require more time to start up and cannot vary the cycle length much. Also, in many OECD countries flexible operation of NPPs is limited or not authorised by national safety authorities; NPPs can therefore offer only limited flexibility capabilities to the TSO.

16. In general, generating plants with steam turbines have high inertia. The inertia of wind turbines is quite low, while solar PV has no inertia.

One to two days are effectively needed for starting up a nuclear power plant from a cold shutdown, slightly longer than a coal plants and considerably longer than a gas plant. Hydroelectricity, if available, is of course the most flexible resource with almost immediate availability. However only a few hours are needed to reach full power from a hot shutdown; run-up to full load can even be faster if the power plant generator remains synchronised with the grid. During a reactor start-up after a refuelling outage, there is usually a need for tests, and a rather slow increase in power over several days in order to condition the fuel. If the nuclear unit has shut down because of an unplanned trip there is likely to be an additional delay before the reactor can restart, because of requirements in the NPP's operating licence to investigate and understand the cause of the reactor trip before the reactor can be returned to power.

From a technical viewpoint, modern nuclear power plants have significant load following and frequency regulation capabilities (see Chapter 3 for a detailed discussion of the load following abilities of nuclear energy). In many OECD countries, such as France and Belgium, NPPs are currently participating in primary and secondary frequency control. Their current load following performances, in terms of ramp rates and power variations, are similar to those of other dispatchable technologies, such as coal generating units. France and Germany are OECD countries where NPPs are extensively operated in a load following mode. However, many of the nuclear power plants in operation are of older design and offer much more limited operational flexibility. If the TSO believes there is a requirement for the nuclear units to be able to operate flexibly, then the requirements should be discussed with the NPP developer very early in the design stage, so it can be considered fully in the design and safety assessment of the plant.

In each country, the permitted range and rules of operation are specified by a nuclear regulatory body when granting the licence to operate the nuclear power plant. Thus, the NPP operator is limited in its capacity to respond to TSO grid operator needs. For example, the United States nuclear regulatory authority permits load changes only under direct control of the staff. Automatic load following or frequency regulation in response to a control signal from the grid operator is therefore not possible in American nuclear power plants. In addition, for economical considerations, many utilities prefer to use nuclear power plants as pure baseload technologies, leaving load following, frequency control and other ancillary services to generating plants with higher marginal costs of operation.

### ***Safety implications of grid disturbances for an NPP***

The situations that could most significantly impact the normal operation and potentially impair the safety of a nuclear unit are the loss of load or load rejection, the loss of offsite power, or degraded grid voltage and frequency conditions. It is the duty of the TSO, the NPP operator and safety authorities to ensure that the occurrence of one of these infrequent events do not lead to any situation that could impair the safety of the nuclear installation.

#### ***Degraded grid voltage or frequency***

Several external events can cause a sharp variation in the voltage and/or frequency at the NPP connecting points. A reduction in frequency is caused by insufficient available generation with respect to demand while a circuit fault or a large generator trip could provoke large drops in frequency. Conversely, sudden disconnection of a large electrical load or to sharp increase of power generation could originate a sharp rise in frequency. A large number of reasons might cause voltage variations on the grid: disconnection of transmission lines, loss of large loads or generation units, or external events on the overhead lines, such as lightning strikes or contact with a third-party live conductor.

Any change in grid frequency affects nuclear power plant operations by changing the speed of the turbo-generator as well as that of the cooling pumps. As a first approximation, the speed of pumps is directly proportional to the frequency of the electric power supply.

Following a grid frequency drop, the output flow of the pumps is proportionally reduced, which leads to less efficient core cooling. This would change the void distribution in a boiling water reactor (BWR) and increase the average coolant temperature in a pressurised water reactor (PWR). All of these effects directly impact the core's reactivity. A rise in frequency results in a reduction of the overall turbine power and thus to a mismatch between reactor power and turbine power, which would cause overpressure in

both BWRs and PWRs. Excess steam would be dumped to the condenser or to the atmosphere and the operator would have to reduce the reactor power in order to match that of the turbine.

In case of extreme frequency variation or prolonged off-nominal frequency conditions, the NPP is isolated from the grid (“system islanding”) in order to maintain the proper frequency and avoiding damages to the turbine and other electrical equipment. The nuclear power plant can also be shut down if the frequency transient is too fast or for frequency variations of  $\pm 7\%$  of nominal values. From the perspective of the TSO, the disconnection of an NPP from the grid and the consequent loss of generating power would further aggravate the power imbalance in the rest of the grid.

Degraded voltage conditions are potentially dangerous for electrical and electronic nuclear equipment. Situations of low voltage lead to abnormally high current in the motors, which could cause overheating and possible opening of protective breakers. These situations could potentially impair the motors’ and stand-by pumps’ ability to start properly. Motors and transformers are generally resilient to over-voltage exposure for short period of time. However, electronic equipment is more sensitive to high-voltage situations and often build-in protections shut down the equipment.

#### *Load rejection and complete loss of load*

A load rejection is a sudden reduction in the electric power demanded by the grid. Such a reduction might be caused by the sudden opening of an interconnection with another part of the grid that was carrying a large load. Load rejections are accommodated by a combination of several actions: rapidly running back the steam turbine to the new lower demand level, diverting the excess steam from the turbine to the main steam condenser unit or to the atmosphere if this is permitted by licensing regulations, and reducing reactor power via insertion of control rods without tripping the reactor. NPP designs are capable of withstanding load rejections of up to 40-50% without tripping the reactor.

In case of a complete loss of load, it may still be possible to “island” the NPP so that it powers only its own auxiliary systems. During this “house-load” operating mode, the reactor operates at a reduced power level that is still sufficient to produce enough electricity for its own needs, typically 5-8% of full power. Once the grid disturbance has been eliminated, the NPP can be re-synchronised to the grid, and its production quickly re-established to full power.

#### *Loss of offsite power (LOOP)*

Any loss of offsite power would be caused by external events beyond the NPP’s switchyard, including transmission line faults and weather effects such as lightning strikes, ice storms and hurricanes. A loss of offsite power interrupts power to all in-plant loads such as pumps and motors, and to the NPP’s safety systems. Typically, a LOOP event results in an automatic scram of the reactor: as a protective action, safety systems will trigger multiple commands for protective trips (e.g. turbine and generator trip, low coolant flow trip, and loss of feed-water flow trip). The reactor protection system will also attempt to switch to an alternate offsite power source to remove residual heat from the reactor core. If this fails, in-plant electrical loads must be temporarily powered by batteries and stand-by diesel generators until offsite power is restored.

## **2.4 Costs for a nuclear power plant**

The costs of integrating the nuclear power plant into the electrical grid arise from connection to the high-voltage grid, reinforcement of the transmission grid to dispatch the bulk power, balancing, and some specific services provided by the TSO to NPP operators to fulfil nuclear safety requirements.

Connection cost accounts for the electrical infrastructure needed to connect the nuclear power plant to the grid, from the step-up and station transformers to the main grid substation. Those costs are proportional to the distance between the power plant and the closest medium-high voltage line and are therefore influenced by the development of the electrical infrastructure in a country as well as the plant location. In France, connection costs are estimated at EUR 2-5 million per kilometre.

Grid reinforcement costs are related to the construction or reinforcement of the high-voltage grid and the creation or upgrade of power substations. An estimate of these costs for France is in the order of EUR 1 million per kilometre of transmission line. Building a new power substation would cost tens of millions of euros and even upgrading an old one would cost at least several million euros. Grid reinforcement costs are strongly dependent on the existing electrical infrastructure and whether the TSO has anticipated or scheduled the integration of the power plant into the power systems. The integration of a new nuclear power plant in a small country which already uses nuclear plants and has a well-developed grid would thus require a few million euros of investment, while integrating the same plant in a large, newcomer country with centres of production and consumption far apart would involve the costs for many new electrical lines and several large substations.

Balancing costs are all of the extra costs that a TSO has to bear in order to ensure short-term supply/demand balancing and the stability and reliability of the electricity supply. In the case of a dispatchable technology such as nuclear, balancing costs reflect only the creation of supplemental reserves of power to cover the frequency drop in the case of a trip of an NPP, but only if the size of the nuclear power plant is bigger than the maximum infeed loss used for the electrical system. The cost depends on the volume (MW) based on the forecasted situation of the power system at the time the NPP will be on line, and on the marginal price of electricity at this time. Finally, the costs of specific services provided by TSOs for NPP operators (grid reliability, data collection, development of emergency restoration procedures, etc.) are estimated in France at several thousand euros/year.

## 2.5 Conclusion

Like all generating technologies in the context of an integrated electricity system, nuclear power poses some constraints and has specific requirements, which generate additional costs to the whole system. On the other hand, nuclear energy has some specific characteristics benefiting the stability and functioning of the electrical grid that should be correctly taken into account when evaluating the system effects of nuclear power.

Nuclear power plants have strong requirements in terms of grid availability and frequency and voltage stability, and these may require improvements in the transmission grid which could be significant in countries that do not yet have nuclear power. Also, nuclear power plants are likely to be the largest generating units in the electrical system, and thus increase the amount of spinning reserves needed to ensure grid stability. Their high load may also require upgrading the grid connection to at least 300 kV, and up to 400 kV for a new European pressurised reactor (EPR). Finally, the necessity of locating nuclear plants close to water sources for cooling purposes may require additional investments in the extension of the existing grid.

On the other hand, due to large inertia of their turbo-generators, large reactive power and dynamic stability, nuclear power plants contribute significantly to the stability of the electrical system in term of frequency, voltage and angle. From an operational viewpoint, TSOs benefit from the very good predictability and reliability of nuclear power, with a small frequency of unexpected outages and a production schedule known well in advance.

## References

- Capgemini (2010), *European Energy Markets Observatory*, 13<sup>th</sup> Edition, November, available at [www.capgemini.com/m/en/doc/0811\\_EEMO10\\_FullReportEN\\_corrections.pdf](http://www.capgemini.com/m/en/doc/0811_EEMO10_FullReportEN_corrections.pdf).
- Consentec/Frontier Economics (2008), *Notwendigkeit und Ausgestaltung geeigneter Anreize für eine verbrauchsnahe und bedarfsgerechte Errichtung neuer Kraftwerke*, Consentec/Frontier Economics report for the German Federal Ministry of Economy and Technology (BMWi), November, Figure 12, p. 42, available at [www.consentec.de/wp-content/uploads/2011/12/anreize-errichtung-neuer-kraftwerke-abschlussbericht.pdf](http://www.consentec.de/wp-content/uploads/2011/12/anreize-errichtung-neuer-kraftwerke-abschlussbericht.pdf).
- Denholm, P., E. Ela, B. Kirby and M. Milligan (2010), *The Role of Energy Storage with Renewable Electricity generation*, National Renewable Energy Laboratory Technical Report NREL/TP-6A2-47187, January 2010.
- D'haeseleer, W. (2011), *Nuclear Energy as Part of the Electricity Generation System – Balancing and the Grids*, TME Working Paper – Energy and Environment, February 2011, KUL Leuven, Belgium, available at [www.mech.kuleuven.be/tme/research/](http://www.mech.kuleuven.be/tme/research/).
- DOE (2009), *Water Requirements for Existing and Emerging Thermoelectric Plant Technologies*, Ph. DiPietro, DOE/NETL-402/08010, April 2009 revision, Washington, D.C., United States.
- EASAC (2009), *Transforming Europe's Electricity Supply – An infrastructure Strategy for a Reliable, Renewable and Secure Power System*, European Academies Scientific Advisory Council (EASAC), Policy Report 11, May 2009, London, United Kingdom, available at [www.easac.eu/fileadmin/PDF\\_s/reports\\_statements/Transforming.pdf](http://www.easac.eu/fileadmin/PDF_s/reports_statements/Transforming.pdf).
- ENTSO-E (2009), *UCTE System Adequacy Retrospect 2008*, European Network of Transmission System Operators for Electricity, Brussels, Belgium, available at [www.entsoe.eu/resources/publications/former-associations/ucte/system-adequacy/](http://www.entsoe.eu/resources/publications/former-associations/ucte/system-adequacy/).
- ENTSO-E (2009a), *UCTE System Adequacy Forecast 2009-2020*, European Network of Transmission System Operators for Electricity, 5<sup>th</sup> January 2009, Brussels, Belgium, available at [www.entsoe.eu/resources/publications/former-associations/ucte/system-adequacy/](http://www.entsoe.eu/resources/publications/former-associations/ucte/system-adequacy/).
- ENTSO-E (2009b), *UCTE System Adequacy Methodology*, European Network of Transmission System Operators for Electricity, 30<sup>th</sup> January 2009, Brussels, Belgium, available at [www.entsoe.eu/fileadmin/user\\_upload/\\_library/publications/ce/UCTE\\_System\\_Adequacy\\_Methodology.pdf](http://www.entsoe.eu/fileadmin/user_upload/_library/publications/ce/UCTE_System_Adequacy_Methodology.pdf).
- EURELECTRIC (2004), *Ancillary Services – Unbundling Electricity Products – An Emerging Market*, Union of the Electricity Industry – EURELECTRIC, Brussels, Belgium.
- Hirvonen, R. (2000), Material for course S-18.113 Sähköenergiäjärjestelmät, Power Systems Laboratory, Helsinki University of Technology, Helsinki University of Technology, Finland.
- IAEA (1983), *Interaction of Grid Characteristics with Design and Performance of Nuclear Power Plants. A Guidebook*, IAEA Technical Reports Series 224, Vienna, Austria.
- IAEA (1984), *Expansion Planning for Electrical Generating Systems. A guidebook*, IAEA Technical Reports Series 241, Vienna, Austria.
- IAEA (2003), *Site Evaluation for Nuclear Installations – Safety Requirements*, IAEA Safety Standard Series N° NS-R-3, November 2003, Vienna, Austria.
- IAEA (2004a), *Format and Content of the Safety Analysis Report for Nuclear Power Plants – Safety Guide*, Safety Standard Series N° GS-G-4.1, May 2004, Vienna, Austria.
- IAEA (2004b), *Design of Emergency Power Systems for Nuclear Power Plants – Safety Guide*, Safety Standard Series N° NS-G-1.8, August 2004, Vienna, Austria.
- IAEA (2009), *Interfacing Nuclear Power Plants with the Electric Grid: the Need for Reliability amid Complexity*, Attachment 5 of IAEA Nuclear Technology Review 2009, Vienna, Austria, available at [www.iaea.org/About/Policy/GC/GC53/GC53InfDocuments/English/gc53inf-3-att5\\_en.pdf](http://www.iaea.org/About/Policy/GC/GC53/GC53InfDocuments/English/gc53inf-3-att5_en.pdf).



- IAEA (2012), “Electric Grid Reliability and Interface with Nuclear Power Plants”, IAEA Nuclear Energy Series, N° NG-T-3.8, March 2012, Vienna, Austria.
- Ithier, J.-C., P. Brunet and J.-F. Astolfi (1998), “Choix des sites des centrales nucléaires”, *Techniques de l’Ingénieur*, 10 April 1998.
- Kirby (2004), *Frequency Regulation Basics and Trends*, document prepared by Oak ridge National Laboratory for the US Department of Energy, ORNL/TM-2004/291, December 2004.
- Kirby et al. (2007), *Nuclear Generating Stations and Transmission Grid Reliability*, 39<sup>th</sup> North American Power Symposium, 30 sept-2 Oct 2007, Las Cruces, New Mexico, United States.
- NEA (2009), *Defence in Depth of Electrical Systems and Grid Interaction. Final DIDEYSYS Task Group Report*, NEA/CSNI/R(2009)10, Nuclear Energy Agency, OECD, Paris, France.
- NRC (2012), *Part 100 – Reactor Site criteria*, United States Nuclear Regulatory Commission, NRC Regulation (10 CFR), Washington, D.C., United States, available at [www.nrc.gov/reading-rm/doc-collections/cfr/part100/full-text.html](http://www.nrc.gov/reading-rm/doc-collections/cfr/part100/full-text.html).
- RTE (2009), “*Contribution des utilisateurs aux performances du RPT. Article 4.1 – Réglage Fréquence/Puissance*”, RTE, Technical Documentation of Reference, Chapter 4.
- STUK (2000), *Safety Criteria for Siting a Nuclear Power Plant*, STUK – Radiation and Nuclear Safety Authority of Finland, Guide YVL 1.10, Helsinki 11 July 2000, Finland.
- UCTE (2006), *Geographical Distribution of Reserves*, UCTE technical document, available at [www.entsoe.eu/resources/publications/former-associations/ucte/other-reports/](http://www.entsoe.eu/resources/publications/former-associations/ucte/other-reports/).
- UCTE (2009), “*Policy 1 Load-Frequency Control and Performance*” and “*Appendix 1 Load-Frequency Control and Performance*”, *UCTE Operation Handbook*, available at [www.entsoe.eu/resources/publications/system-operations/operation-handbook/](http://www.entsoe.eu/resources/publications/system-operations/operation-handbook/).
- WNA (n.d.), *Is the Cooling of Power Plants a Constraint on the Future of Nuclear Power?*, World Nuclear Association Position Statement, London, United Kingdom, available at <http://world-nuclear.org/uploadedFiles/org/reference/pdf/PS-cooling.pdf>.



### Chapter 3

## The contribution of nuclear power to the minimisation of system effects in the short and long run

In integrated electricity systems, each individual power plant has impacts on the total costs of the electricity system beyond the usually measured plant-level costs. This holds for all technologies, and nuclear power is no exception, although the system effects created by variable renewables are frequently of a different magnitude than those created by dispatchable technologies. However, in evaluating the contribution of different technologies to the smooth working of the electricity system it is not only important which system effects they generate but also to which extent they are capable of dealing with the system effects generated by other technologies.

Of key importance in this context is the flexibility a technology possesses to adjust its load in reaction to changes in demand as well as the variable supply of non-dispatchable technologies. Due to the absence of widely available and economically feasible storage, each electricity system has to maintain a constant balance between supply and demand by adapting the generating power. Load also needs to be adapted to forecasted and unforecasted changes in supply and demand as well as to unexpected faults in the system, such as the unscheduled shutdown of a generating unit or transmission line. Such load following allows the alignment of the overall system supply with daily, weekly and seasonal demand variations.

In recent years, the integration of a large share of variable renewable into the electricity system has increased the complexity of the balancing challenge by adding an additional source of variability and unpredictability from the supply side. Variable renewable production fluctuated upwards and downwards according to the availability of the resource (wind, waves, tide, cloud cover, rain, etc.) and those fluctuations are considerably less regular and predictable than those of demand. As can be seen in Figure 3.1, the integration of variable renewable increases the aggregate variability and unpredictability of the residual demand (the blue line, which corresponds to electricity demand minus the variable renewable production) as seen by the power system.

The main source of flexibility is constituted by dispatchable power plants. Traditionally, this role was limited to peaking power plants during periods of high demand, which include primarily hydropower, gas- and oil-fuelled plants. However, as the share of renewables increases, baseload plants such as coal-fired and nuclear power plants are increasingly called upon to contribute to the flexibility of the electrical system: this trend will continue in the future. Nuclear and coal units are already participating in frequency control in many countries and, to a lesser extent, in secondary control and load following.<sup>1</sup>

---

1. Energy storage, demand side management and improved interconnections can also provide flexibility to align demand and supply in the face of fluctuating supply from variable renewables such as wind. However these options are frequently still more expensive than traditional back-up by dispatchable power plants. Chapter 5 discusses how these various options can be combined in order to arrive at a least-cost provision of flexibility.

While coal- and gas-fired power plants are also capable of load following, nuclear energy is the only low-carbon technology not limited in supply that is capable of doing so. This chapter will thus focus on the ability of nuclear energy to provide in a flexible manner reliable and dispatchable low-carbon electricity both in the short run and the long run. The short-run provision of flexible electricity supply concerns primarily the balancing challenge that was briefly presented in Chapter 1, when the variable supply of renewables such as solar and wind, needs to be quickly balanced according to changing weather conditions. A key parameter in this context is the “ramp rate” of a technology, i.e. the speed with which a power plant can modulate its output. The first part of this chapter provides an extensive discussion of the technical ability conditions of nuclear to engage in load following in the short run.

**Figure 3.1: Variability of demand and wind generation**

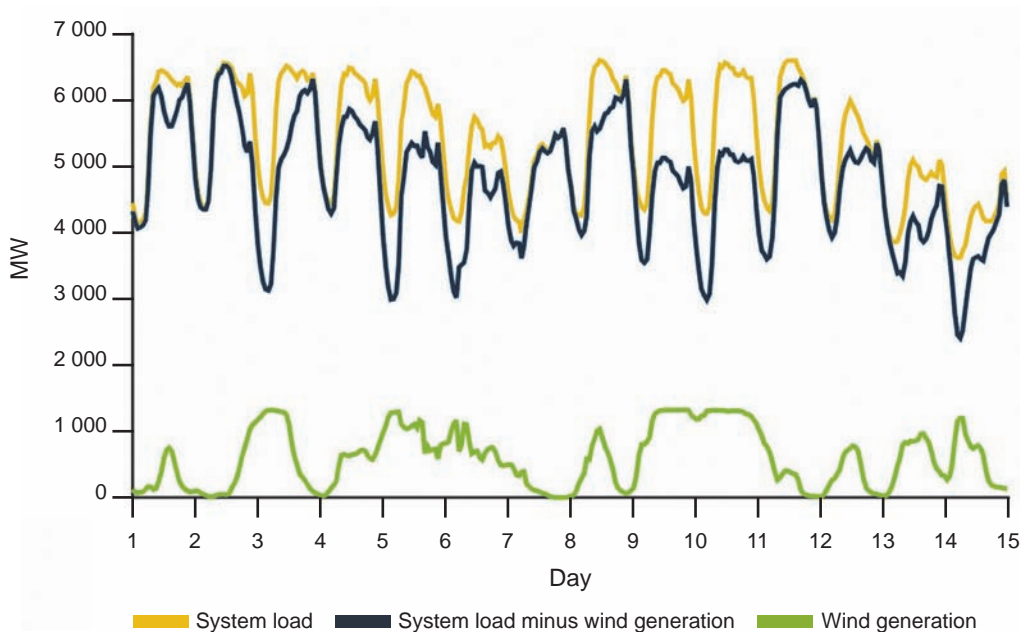

Source: DOE, 2008.

The second part of this chapter will assess how the management of nuclear fleets can optimise the contribution of nuclear power to the available dispatchable capacity as well as the annual output of the electricity system over the fuelling cycle by co-ordinating the fuelling cycles with seasonal demand fluctuations. This constitutes as much a minimisation of the system costs of nuclear power itself (since its effective availability is less than 100% of rated capacity) as a contribution to ensuring the adequacy of the electricity system at all times even in the presence of significant amounts of variable renewables. It will be shown that optimised nuclear fleet management can have significant economic impacts via the reduction of both the maximal residual electricity demand and the need for more expensive non-nuclear electricity.

### 3.1 The flexibility potential of nuclear power plants in the short run

This section analyses load following capabilities and flexibility performances of nuclear power plants. Following a brief introduction, several examples of load following in France and Germany will be presented. While for reasons of operational ease and economic efficiency nuclear power plants in most OECD countries are operated in a baseload mode, France and Germany, due to different causes, have significant experience with operating their current reactors, both PWRs and BWRs in a load following mode. The presentation of this experience will be complemented by a discussion of the technical aspects of load following with nuclear power plants which includes a description of the physical phenomena intervening in the reactor core and a summary of the operating modes currently employed in modern nuclear plants. The technical section concludes with an analysis of the impact of flexible operation on the operational performance of a nuclear unit and its lifetime. In a second part, some economical aspects of load following are analysed in greater detail: the increase in production cost due to load following and the potential economical benefits of flexible operation.

The terms “power plant flexibility” or “load following capacity” are commonly used to express the ability of a power plant to change electrical output in response to external inputs. Those terms, however, encompass a large range of grid request and power plant operating modes: the extent of the power change, its speed (ramping rate) and the predictability of the request are important aspects to be considered. In order to avoid confusion, we group different power plant operating modes into four categories.

*Baseload operation:* Baseload power plants operate at a constant power (usually at the maximum rated power) during the whole cycle. Operation at the design power allows achievement of the maximal efficiency of the plant. Start-up, shutdown and load changes are very infrequent, dictated by maintenance and refuelling needs or by unplanned/incidental external circumstances. Baseload plants are generally characterised by low operating and high investment costs. Among conventional source of energy, nuclear and coal-fired plants are generally operated in a baseload mode. Biomass, biogas, geothermal and river-hydroelectric plants are typical renewable baseload plants.

*Frequency control:* Power plants participating in frequency control have the obligation of reducing or increasing their operating power by a predefined amount that can be called upon by the grid. These plants operate at a reduced output level  $P_0$  and their load varies in the  $[P_0 - P_r, P_0 + P_r]$ , where  $P_r$  is the margin that can be called by the grid.

Power plants participating in the primary frequency control automatically reduce or increase their power output in response to the system’s frequency increase or decrease; in France, the primary frequency control margin is of 2% of nominal power. A critical issue on primary frequency control is the time needed for varying the power output: in large interconnected systems, such as the United States and continental Europe, the critical time is between 15 and 30 seconds. In smaller and more isolated networks the critical time is considerably shorter, 5 and 10 seconds in Ireland and the United Kingdom, respectively.

Power plants participating in secondary frequency control reduce or increase their output power in response to an automatic signal sent by the grid operator; secondary frequency response must be activated in a time frame ranging from 30 seconds to 15 minutes. In France, the secondary control margin for nuclear plants is 5% of nominal power. Some nuclear power plants participate in both primary and secondary frequency control; their power level is thus reduced by 7% with respect to a unit that would operate in a baseload mode. The activation of tertiary reserves is performed by the power plant operator within a much longer time frame.

*Daily or weekly planned load following:* These generating plants follow a planned and predefined load cycle that aims to adapt the electricity supply curve to the cyclical variations in demand. Typically, these plants operate at full power during the whole day, gradually ramp down power in the late evening and gradually return back to full power in the early morning. In some cases, the plant schedule differs between working and non-working days; in the latter, the plant usually operates at low power for extended periods or, eventually, during the whole day.

*Reacting flexibly to electricity price changes:* By “price reactivity” we mean the ability to increase/reduce the power output or to start up/shut down a generating unit in response to a price variation in the electricity market. Oil- and gas-fuelled power plants and reservoir-based hydro plants, used for peak load, have this “price-flexibility” capacity. As will be shown below the increasing volatility of European wholesale electricity prices, which includes recurrent instances of negative prices, has also provided substantive incentives for load following of nuclear plants.

The majority of nuclear power plants have been operated in a baseload mode and only a few countries have required some flexibility from nuclear units. This is essentially due to economic reasons. Since nuclear energy has the lowest marginal (and the highest capital) costs among large conventional generating technologies, nuclear power plants should be operated at nominal power as much as possible in order to maximise the energy produced and recuperate the large investment costs. For an electrical utility with a diversified portfolio of generating plants, it is thus economically more attractive to require some flexibility from a coal, a gas-fuelled or a hydro-electrical power plant than from a nuclear unit. However, in some countries the share of nuclear energy in the electricity mix has become so important that the utilities have had to implement or improve the manoeuvring capabilities of the nuclear plants. This is the case of France (78% of nuclear electricity production) as well as Belgium and the Slovak Republic (both more than 50% of nuclear electricity production). Another motivation for load following with nuclear power plants is the large-scale deployment of variable energy sources in some countries, like Germany. In the following, we provide some examples of load following operations by French and German nuclear power plants and how nuclear energy contributes effectively in balancing the fluctuations of total power generation.

Beside technical and economical considerations, another limiting factor to nuclear plants flexibility is the attitude of nuclear safety and regulatory authorities. The American NRC, for instance, does not allow any automatic load following; nuclear units therefore cannot provide primary and secondary frequency control services. On the contrary, Belgian, French and German regulators allow for automatic load following and other forms of flexibility.

In France, for instance, nuclear units effectively ensure part of the 650 MW reserves required for primary frequency control and several units participate actively in secondary frequency control. Also, some units are operated in a daily (or weekly) load following mode. The operating parameters for the three reactor types used in France are summarised in Table 3.1.<sup>2</sup>

**Table 3.1: NPP regulation margins in France**

Start-up time	Amplitude	900	1 300	N4
Reactor reference power		900 MW	1 300 MW	1 500 MW
Primary frequency control	± 2%	± 18 MW	± 26 MW	± 30 MW
Secondary frequency control	± 5%	± 45 MW	± 65 MW	-

Source: EC JRC, 2010.

Daily load following in France is done according to different load patterns. The most common is the so-called 12-3-6-3, with 12 hours at full power and 6 hours at low level power. The ramping rates are quite slow, with 3 hours time for the upward and downward power transients. Other load patterns commonly used are 16-8, and 12-12, also with low ramping rates. A special load pattern described in (Kerkar and Paulin, 2008), referred to as 18-6, is characterised by 18 hours at full power, followed by a fast transition to a low power stage, with ramping rates of 2-5%/min. Under this mode the reactor is able to quickly go back to the nominal power, with a fast ramp rate of 5%/min. According to Coppolani *et al.* (2004), power transients in French nuclear power plants are generally very slow, below 0.5%/min of nominal power, exceeding 1.5%/min of nominal power in only 2.5% of all cases. Minimal power is also kept within the 50%-75% range in 90% of the cases.

2. N4-type reactors are not operated as secondary frequency control.

Figure 3.2 provides an interesting snapshot of the dispatching of different power plants in a two-week time interval in November 2010. Total generation and load are represented by the black and red lines; the imbalance between electricity generation and load is covered by exchanges with neighbouring countries. While hydroelectric power (the light green line) ensures the majority of load variation, gas and coal-fuelled power plants operate in a load following mode, reducing output at night and during the week-end. It also appears clearly that nuclear units provide daily and weekly load following: on two week-end nights, total nuclear production decreased by about 7 GW in a few hours and returned to previous values the following morning.

**Figure 3.2: Example of the electricity generation in France during 2 weeks in November 2010**

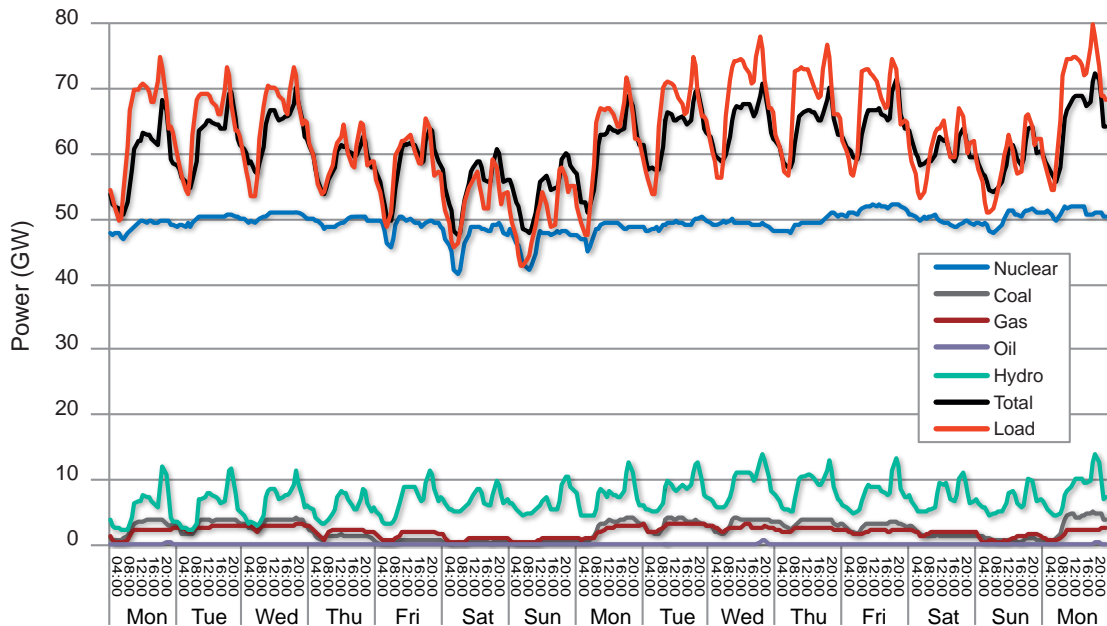

Source: Based on RTE data – Réseau de Transport d'Électricité, France.

Figure 3.3 shows the power history of a nuclear power plant during a whole cycle, from start-up to shutdown for fuel reloading; the lower plot shows a shorter 10-day period (around Christmas time in 2008) in greater resolution. The extent and frequency of load modulation can clearly be seen. In the first two thirds of the irradiation cycle, the load fluctuates continuously within 85% to 100% of full power in response to grid needs; daily load following can also be observed, with load reduction down to 30-40% of nominal power. In the last third of the irradiation cycle, the plant is operated in a baseload regime and only a few load variations are observed.

Since the mid-1970s, German nuclear power plants were designed specifically for a flexible load and have been successfully operated in such a manner over the last 30 years. The rationale behind this choice was the forecast of a larger proportion of nuclear energy, and the presence of small grids. Today, however, it is the large share of variable renewable which requires flexibility from all dispatchable electricity sources, including nuclear energy. The amount of recent load following that has been undertaken in Germany by nuclear power plants is quite remarkable. Figure 3.4 shows the daily variation in the nuclear energy output showing clearly the extent of the load following capacity of the nuclear park in Germany.

**Figure 3.3: Example of the power history of a French PWR reactor engaged in load following**

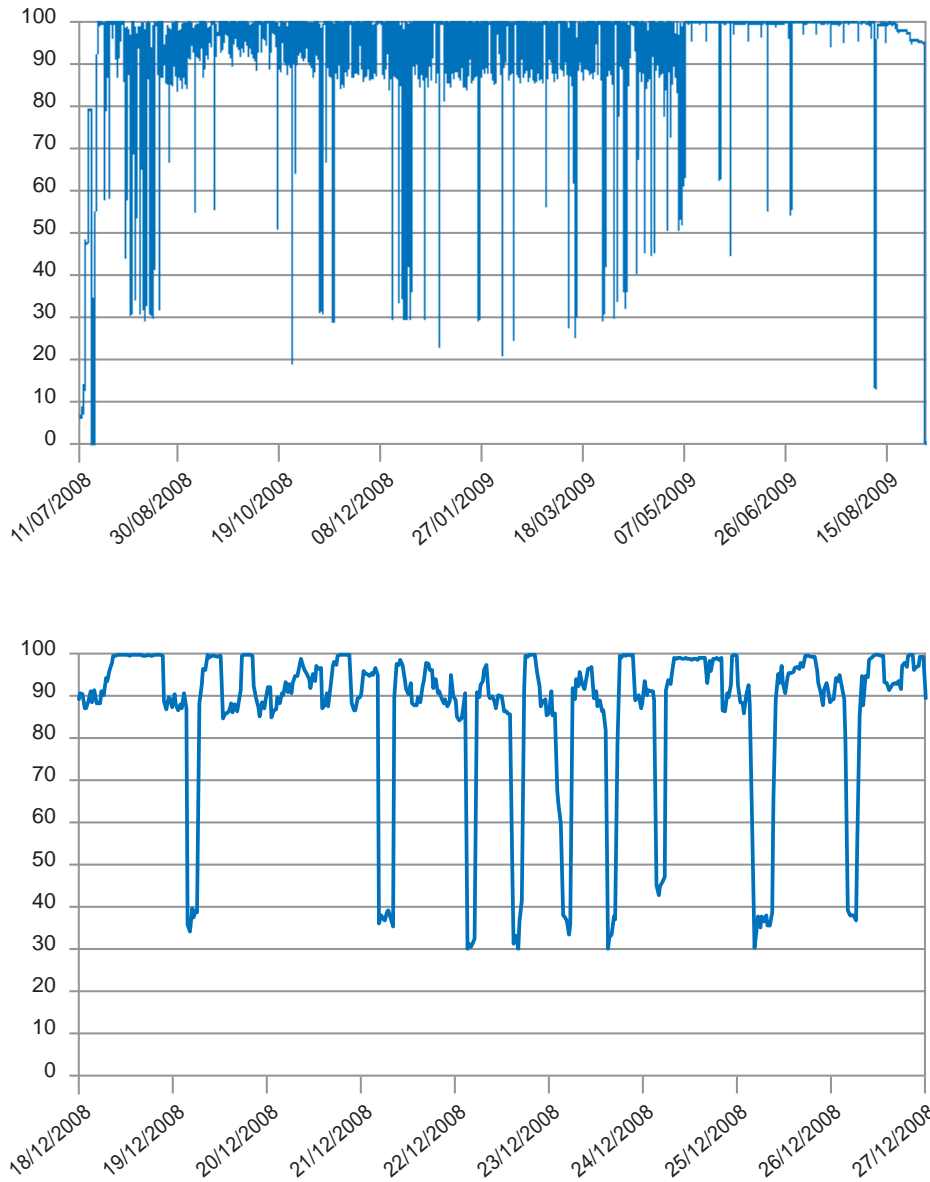

Source: Courtesy of EDF, France.

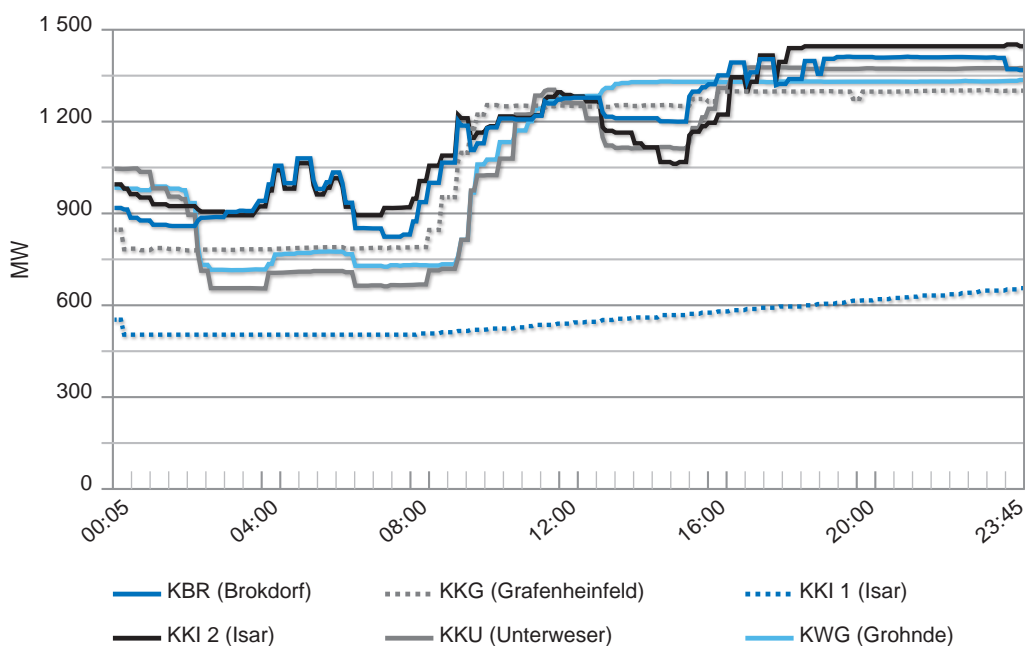

**Figure 3.4: Load following operations of E.On nuclear units in Germany**

Source: Courtesy of E.ON Kernkraft, Germany.

### **The technical ability of nuclear power plants to engage in load following**

As mentioned in the previous section, only a few countries have the economic incentive or the operational necessity to run nuclear power plants in a flexible way; there is therefore limited operating experience and information on this subject. The contents of this section are mainly drawn from the experience of load following in France, Germany and the Russian Federation.

Any variation of reactor power in a nuclear power plant has both immediate and long-term consequences on the reactivity, stability and manoeuvrability of the reactor. Following the power variation, there is a modification of physical conditions in the core, such as fuel temperature, and coolant temperature and density. These changes have a feedback effect, via neutron counter-reactions, on the core reactivity as well as on the neutron flux and power distribution across the core. These effects play an important role in the safety of a nuclear plant and in the nuclear reactor manoeuvrability. The main short-term counter-reactions in light water reactors (LWRs) are due to the fuel temperature change (Doppler effect), the coolant density and temperature changes (coolant effect) and the change in power distribution. On a longer time frame (several hours after the power change), accumulation of some fission products (xenon and samarium) may have an important effect on core reactivity and power distribution. A rise in reactor power leads to an immediate increase of average fuel temperature and to a change in the spatial distribution of temperature within the fuel pin. Higher power levels result also in higher average coolant temperature in the core.

At higher fuel temperatures, there are more neutron captures and fissions from heavy nuclides in the resonance energy region, due to the Doppler effect. In all commercial reactors the overall effect is a reactivity reduction, due to a large fraction of  $^{238}\text{U}$  in the fuel. The Doppler effect has an important stabilising effect in nuclear power plants.

A change in reactor power has also a significant impact on coolant average temperature and density: a power increase reduces the total amount of water (and boron) in the core. This leads to less parasitic neutron absorption and thus to a slight reactivity increase. On the other hand, the neutron spectrum becomes faster, which results in a less effective neutron balance. Operational LWRs are designed in such a way that any increase in the coolant temperature results in a reactivity reduction, which decreases the reactor power (and the coolant temperature); thus the moderator effect also has an important stabilising effect in a nuclear core. A power level variation also changes the axial temperature distribution of coolant in the core: a power increase leads to a larger temperature gradient between the bottom and the top of the core. The neutron flux and the power distribution are pushed further into the lower part of the core. This effect is particularly relevant in boiling water reactors, in which the water changes state in the core.

Xenon is responsible for the most important long-term effect on reactivity, known as the xenon effect. Xenon 135 is an extremely strong neutron absorber and thus is of a great importance in the core neutron balance.  $^{135}\text{Xe}$  is a radioactive isotope with a half life of 9.17 hours; it is created in a nuclear reactor by radioactive decay from  $^{135}\text{I}$  (with a half-life of 6.6 hours), produced directly by fission. At the beginning of irradiation,  $^{135}\text{Xe}$  is not present in the reactor and slowly builds up with time. After a few days of operation at a stable power,  $^{135}\text{I}$  and  $^{135}\text{Xe}$  achieve their equilibrium level, which is almost directly proportional to the power level: at equilibrium the neutron absorption by  $^{135}\text{Xe}$  is compensated for by the decay from  $^{135}\text{I}$ .

If power is increased, the  $^{135}\text{I}$  concentration grows exponentially to reach a new equilibrium at a higher concentration level. The  $^{135}\text{Xe}$ , generated by  $^{135}\text{I}$  already accumulated in the core, is consumed at a higher pace, proportional to the new power. Hence, the  $^{135}\text{Xe}$  concentration in the core drops and reaches a minimum after about 3 hours; then the  $^{135}\text{Xe}$  concentration increases until reaching a new equilibrium at a higher level. The decrease of the xenon level, with respect to the equilibrium value for that power level, results in a reactivity increase that must be compensated for by the operator. A similar but opposite trend can be observed if power is reduced: the  $^{135}\text{I}$  concentration decreases to a new equilibrium value while the  $^{135}\text{Xe}$  concentration increases, attains a maximum after about 7-8 hours, and finally decreases to reach a new equilibrium level. The excess of  $^{135}\text{Xe}$  with respect to the equilibrium value leads to a reactivity decrease.

The xenon reactivity effect depends on the power level before and after variation and on the time after the variation. Since the xenon effect is shifted in time with respect to the reactor power variation, it represents a significant challenge to the manoeuvrability of the plant. Under certain circumstances, the xenon effect on core reactivity is so substantial that the reactor cannot be restarted for a certain time after shutdown. Also, if control rods are used for power variations, they can deform the axial power distribution and thus create an axial imbalance in  $^{135}\text{Xe}$  distribution. Management of these axial power imbalances and oscillations is an additional challenge for operations in load following mode, especially in the case of large power variations.

Finally, fuel burn-up has a long-term effect on core reactivity and an indirect influence on reactor manoeuvrability. In conventional LWRs, fuel reactivity decreases with burn-up: absorbing fission products accumulate in the fuel and fissile nuclides tend to disappear at a faster rate than that of breeding fissile isotopes from fertile heavy nuclides. Thus, core reactivity is at a maximum value at the beginning of the cycle and decreases to zero by the end of the cycle. The excess reactivity during the cycle is compensated for with neutron absorbers, such as control rod insertion, boric acid or other burnable poisons. At the end of the irradiation campaign, core reactivity is close to zero, boron concentration is also almost zero and control rods are fully extracted from the core, thus reducing operator manoeuvrability. Reactivity variation with fuel burn-up is much slower than the phenomena described in the preceding paragraph and has no direct impact on reactor dynamics during and after load following operations. However, fuel-burn-up has an influence on the load following ability of a nuclear power plant: after a certain point in the cycle, there is not enough reactivity reserve margin in order to allow load following power transients.

### *Main reactivity control mechanisms*

In nuclear reactors there are two main methods of compensating for reactivity changes: dilution of boric acid in the coolant and insertion of control rods.

Boron-10 is a very strong neutron absorber that is diluted in the coolant in order to regulate core reactivity. An increase of boron concentration in the coolant increases the parasitic neutron captures thus reducing overall core reactivity; on the contrary a boron concentration decrease results in lower neutron captures and thus in a reactivity increase. The increase in the boron concentration is obtained by adding boric acid to the coolant: the maximal rate of boron increase in the coolant is about 25 ppm/min. On the other hand, reducing the concentration of boron in the coolant is done by diluting the coolant with fresh, non-borated water; the time needed for halving the boron concentration is about five hours. The rate of decrease in boron concentration hence depends on the initial boron level and is particularly slow at low concentrations, which makes this method less efficient at the end of the fuel cycle. In addition, coolant dilution with fresh water generates a large amount of effluents that must be treated and disposed of by the chemical volume control system.

The main advantage of using boric acid as a reactivity control method is that boron is uniformly distributed in the core and therefore does not affect the axial and radial power distribution. On the other hand, the low rates of boron concentration increase and decrease and the generation of large quantities of effluent limit considerably the effectiveness of this method for compensating short-term reactivity variations, especially at the end of the fuel cycle.

Control rods constitute of stainless steel tubes filled with highly neutron absorbing materials such as boron carbide, Ag-In-Cd or hafnium alloys, which are inserted within the fuel assembly in special guide tubes. The presence of such large thermal absorbers reduces significantly the local thermal flux and power, as well as the overall reactivity. As an example, the insertion of a black control rod would reduce power by 50% within the fuel assembly. Less absorbent control rods, known as “grey” rods, have recently been developed and used in nuclear reactors, with the objective of reducing the perturbations on local flux and power distribution. The use of grey rods allows for a finer reactivity control and effectively reduces the power distribution distortion within the reactor core.

Control rods are an efficient method for adjusting the reactivity in the short term, but their utilisation presents some disadvantages due to the modification of axial and radial power distribution within the reactor core. A control rod insertion causes a large power drop in the surrounding assemblies but can lead to a power increase in some other elements in the core, resulting in additional thermal stress in the assemblies. Also, the rapid insertion/extraction of a control rod might cause axial oscillations of power due to the xenon effect. In addition, the long-term insertion of a control rod in the fuel might cause an uneven depletion of the fuel assembly, a less efficient fuel utilisation and a power imbalance between the upper and the lower part of the core. Finally, the lifetime of a control rod is limited by the burn-up of the absorbing isotopes and by the swelling of the material in the neutron flux that can cause deformation of the control rod. Frequent use of control rods for reactivity variation can therefore shorten their lifetime.

### *Operations with pressurised water reactors*

Pressurised water reactors constitute the majority of industrial nuclear power plants in the world. Cooling and neutron moderation is ensured by demineralised light water, circulating at high pressure in the primary circuit (see Figure 3.5). The water is pumped into the bottom part of the vessel and flows through the core, ensuring the cooling of the nuclear fuel while increasing its temperature. The coolant is then transferred to a steam generator where heat is transferred to the secondary circuit.<sup>3</sup> The coolant is then pumped back to the reactor to continue the process. Each primary loop has a pressuriser that maintains the reactor primary pressure within the operating margins and limits pressure variations during power transients. In the secondary circuit, the steam produced in the steam generator goes into the turbine where thermal energy is converted into mechanical energy. The resulting exhaust steam is then condensed and pumped back into the steam generator.

3. The cooling system in a PWR generally consists of three or four independent loops.

Figure 3.5: General scheme of a PWR

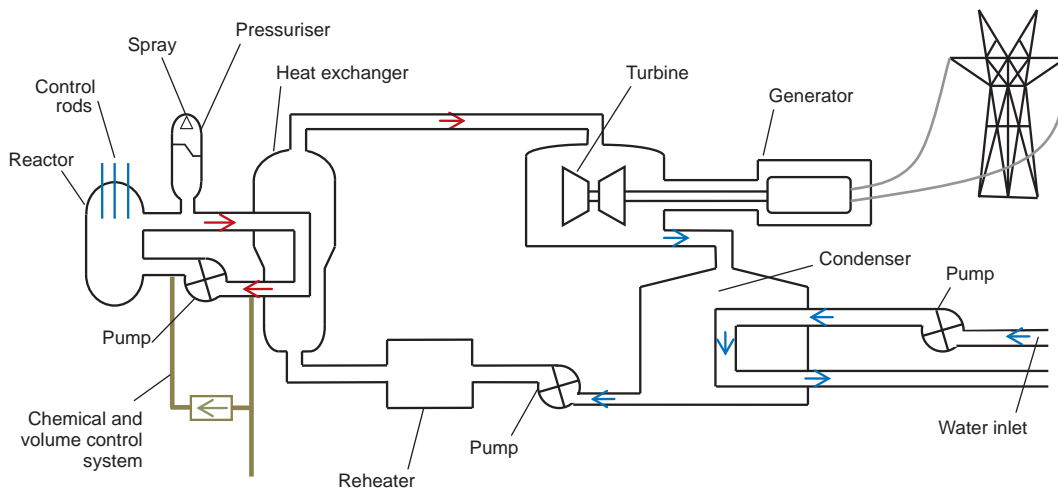

Source: NEA, 2011a.

Power regulation in a PWR is achieved by inserting control rods from the top of the core or by varying the concentration of boric acid in the coolant. Control rods have different purposes for PWR operations: some groups are used for emergency shutdown of the reactor (scram), while others are used to modify the overall reactor power and to correct radial and axial power imbalances. Still other groups allow for a fine tuning of reactivity and temperature. Due to the long delay between injection into the system and the effect in the core (15 minutes approximately), boron cannot be used for load following operations; its use is limited for compensating the reactivity decrease with burn-up and the xenon effect.

The temperature of the coolant in the primary and secondary loops varies with power level according to two main options, as shown in Figure 3.6. The first option, adopted by the majority of French nuclear units, keeps the pressure in the secondary loop constant with the power level. This choice allows for a lower pressure in the secondary circuit and for a higher thermodynamic efficiency of the energy conversion. On the other hand, the average coolant temperature in the primary loop (and hence its volume) increases with power. This increases the size of the pressuriser and the mechanical constraints that it undergoes during a power transient. Also, the reactivity variations with a power change are more pronounced, which implies a larger use of control rods.

The second solution, adopted by German nuclear power plants and by the EPR, keeps the average temperature in the primary circuit constant for power levels superior to 40-60% of nominal power. In that way, the volume of water in the primary circuit remains constant. This option reduces constraints on the pressuriser and minimises the reactivity swings associated with power variations, thus easing the use of control rods during load following transients. On the other hand, the pressure in the secondary circuit varies with the power level, which creates additional constraints on the turbine.

### Operations with boiling water reactors

The design of boiling water reactors has considerably evolved over time in comparison to pressurised water reactors. However, the most general difference between the two reactors is that in the boiling water reactor (a schematic view is given in Figure 3.7) there is a single circuit and no steam generator or pressuriser. The light water (used as coolant and moderator) boils directly in the core. The steam produced is separated and dried in the upper part of the pressure vessel, and then directly transferred to the turbine. The steam is then condensed, re-heated and re-injected into the bottom part of the core.

**Figure 3.6: Typical temperatures for a French 1300 PWR (left) and a German PWR (right) as a function of the power level**

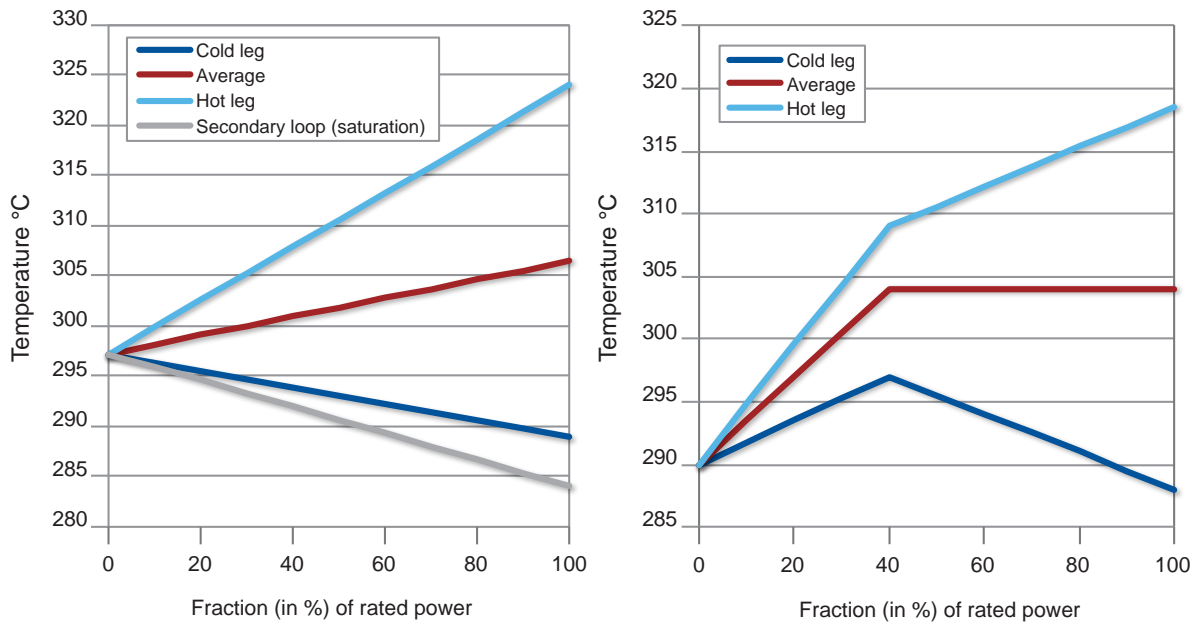

Source: NEA, 2011a.

**Figure 3.7: General scheme of a conventional BWR**

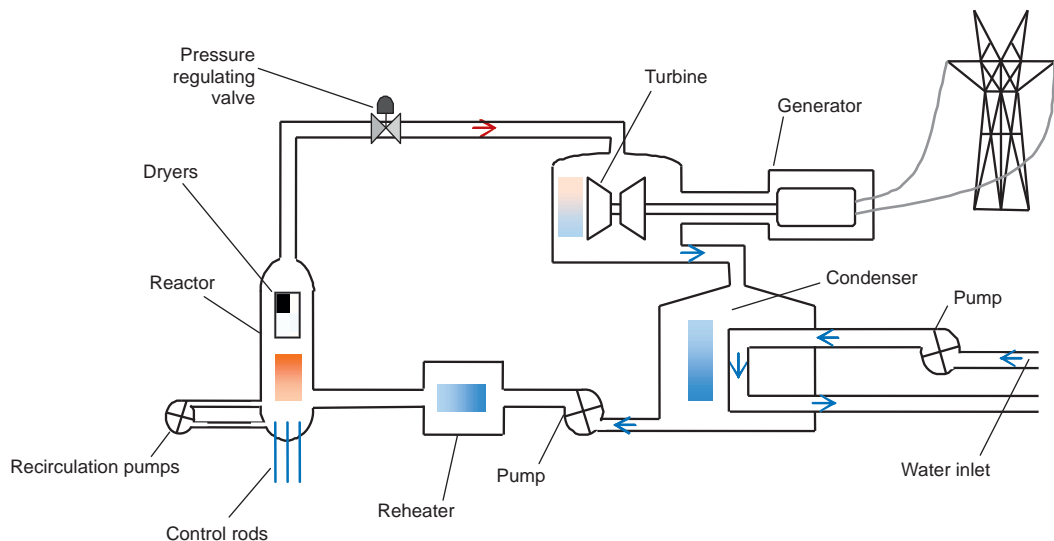

Source: NEA, 2011a.

The conventional and some advanced BWR designs are equipped with re-circulating pumps that change the coolant flow within the core: reactor power regulation and reactivity control is done by changing the coolant flow rate (using the recirculation pumps) and via control rods. Unlike in PWRs, in BWRs the control rods are inserted from the bottom of the core. Some early designs and some advanced BWRs (such as the ESBWR, economic simplified boiling water reactor) only use natural circulation in the vessel; reactivity control and power transients are managed with control rods. Regulation with boric acid is not performed in a BWR, as water changes phase in the core.

Power regulation by changing the coolant flow rate profits from the negative coolant temperature coefficient of reactivity. Increasing the recirculation pump speed and thus the coolant flow, results in lower coolant temperatures in the core. Thus the coolant density increases and, more importantly, the void fraction decreases; neutron moderation then becomes more efficient with a positive effect on the overall core reactivity. Conversely, a speed reduction of the recirculation pump would decrease the coolant flow, thus increasing coolant temperature and the core void fraction. The overall result is a decrease in core reactivity.

The recirculation for controlling power is particularly suitable for load following in the power interval of 60 to 100%  $P_r$ . The main advantage of this method is that the power distribution in the core is not changed, contrary to the case of regulation with control rods. Also, this method allows rapid power variations, with ramps of up to 10%  $P_r$  per minute (Ludwig, 2010). Operation below 60%  $P_r$  typically requires the use of control rods.

Modern advanced boiling water reactor (ABWRs) can reach 100%  $P_r$  in less than 5 hours from a hot condition and in less than 25 hours from a cold shutdown condition. The direct and strong interrelationship between reactor thermal power and steam flow rate gives significant flexibility advantages to an advanced BWR. In the 65%-100% power range, an ABWR can change power automatically via recirculating pumps in response to the turbine request, with ramping rates of up to 1%/sec. Below 65%, the ramping rate is approximately 2.5% per minute, using control rod adjustment (GE, 2006).

#### *Additional needs in term of instrumentation requirements*

Operating a nuclear power plant in a load following mode increases the requirements with regards to reactor regulation and control as well as in-core and out-core monitoring. In the last decades, however, considerable progress has been made in these areas, with the progressive automatisisation of regulation and control operations and significant improvements in data acquisition and processing techniques. This has significantly increased the performance of nuclear power plants during load cycling, and has also had a beneficial effect on overall plant availability.

A prompt and accurate in-core measurement system, coupled with analytical software, is essential to measure and reconstruct neutron flux and power distributions across the core, and local power densities. The timely flow of reliable in-core measurements, together with an automatic and efficient operational control system, allows for a quicker detection of deviations and for the prompt restoration of normal values. In addition, in-core measurement reduces considerably the uncertainties on the power and power density distribution associated with load cycling transients, thus reducing the safety margins that must be taken.

A recent publication on load following capabilities of German nuclear power plants, relates that considerable experience on advanced in-core instrumentation and operational control has been accrued in Germany in recent decades (Ludwig, 2010). Improvements in this area have permitted for greater operation margins and faster transients in load cycling operations. Also, the overall availability of the plants has increased.

### **Flexibility performance of nuclear power plants in theory and practice**

#### *Current industry requirements for new reactor designs*

At the end of the 1980s, utilities from the United States, Europe and Asia united their efforts in preparing a set of requirements for advanced light water reactors. In 1990, the first edition of the Utility Requirements Document (URD) for the advanced light water reactor (ALWR) was issued by the Electric Power Research Institute (EPRI) in the United States.<sup>4</sup> In 1991, five European utilities prepared the European Utilities' Requirements (EUR) with the objective of harmonising the design and guiding the development

4. The current version of the ALWR URD is available at <http://urd.epri.com/>.

of future power plant to be built in Europe (EUR, 2001).<sup>5</sup> The EUR cover a broad range of conditions for a nuclear power plant to operate efficiently and safely; they include areas such as plant layout and specifications, systems, materials, components, probabilistic safety assessment methodology and availability assessment. The EUR explicitly state that modern reactors should implement significant manoeuvrability capability and, in particular, be able to operate in load following mode. The following points summarise the EUR concerning load following and operability of nuclear power plants. Similar requirements are established in the Advanced Light Water Reactor Utility Requirements Documents from EPRI.

*Primary frequency control:* Nuclear units should be able to take part in the primary frequency control of the grid. The primary control range should be  $\pm 2\%$  of the nominal power but higher values, up to  $\pm 5\%$ , should be achievable. The primary frequency control reserves shall be activated within 30 seconds and maintained for at least 15 minutes.

*Secondary frequency control:* Nuclear units should be able to take part in the secondary frequency control of the grid. The secondary control range should be at least  $\pm 10\%$  of the nominal power and should be activated with a minimal speed of 1%/min. Higher ramping rates shall be achieved, with a maximum speed of 5%/min.

*Manoeuvring capabilities:* The nuclear unit should be capable of continuous operations between 50% and 100% of the rated power. The nuclear reactor designer may provide a design that could be operated even at a lower level (usually 20% of the rated power) with the ability to return back to full power without shutting down the plant.

*Load following capabilities:* The nuclear unit should be able to implement a scheduled load following operation during 90% of the whole fuel cycle, with a minimal ramping rate of 3%/min. Daily load following operations should be achieved without adjusting the boron concentration in PWR and by adjusting re-circulation flow control in BWR, with a minimal control rod adjustment. The nuclear unit should be able to go through the following number of load variations: 2 per day, 5 per week and 200 per year.

The modern and advanced water reactors that will be deployed in OECD countries satisfy the utilities' requirements defined by the EUR or the EPRI documentation for the ALWR. Thus, all these designs satisfy the minimum manoeuvrability requirements described above. For illustrative purposes, the description of the manoeuvrability capabilities implemented in the EPR is given below.

The EPR is designed to provide daily load following capabilities in a power range going from 25% to 100% of the nominal power for 80% of the fuel cycle. A maximal ramping rate of 5%/min is allowed in the power range of 60%-100% of  $P_r$  ("light" load following). In the case of deep load following (in a power range between 25% and 60%) the maximal ramping rate is reduced to 2.5%/min. Maximal ramping rates have not yet been defined for higher burn-up.

Primary and secondary frequency control are authorised in combination with daily load following. The margin for primary frequency control is  $\pm 2.5\% P_r$ , with a maximal ramping rate of 1%/sec. A reserve margin of  $\pm 10\% P_r$  can be deployed at a maximal rate of 2%/min for secondary frequency control in the power range between 60% and 100%. If the reactor is operating at a reduced power (between the minimal rated power and 60%), the margin for secondary control and the maximal speed are reduced to  $\pm 10\% P_r$  and 2%/min, respectively. Higher rates of up to 5%/min are acceptable in the case of major disturbances.

### *Load following operability and licensing issues*

The Utilities Requirements Document in the United States and the European Utilities' Requirements are industry standards that result from a form of self-regulation. As such they have no immediate impact on the emission of operating licenses by regulators. The latter are free to set their own criteria, although there is, of course, an ongoing dialogue on these issues between industry and regulators. In each country operating nuclear power plants, a regulatory authority defines the responsibility of the plant operator and the safety and operational limits that have to be fulfilled in all operating conditions. During the licensing process, the mode of NPPs' operation is defined, and all types of authorised transients are analysed.

5. Presently, EUR promoters include British Energy, EDF, Fortum, Iberdrola, NRG, Rosenergoatom, Sogin, SwissNuclear, Tractabel, VTO, Vattenfall and VGB PowerTech.

In both France and Germany, load cycling is explicitly defined in the operating handbook of the NPPs. In France, for example, the possibility of load following is taken into account in the operating manual through a certain number of specific margins associated with operating in a manoeuvring regime. To define these margins, a certain number of load patterns are selected and analysed [for example 18 hours at full rated power ( $P_r$ ), 5 hours at 30%  $P_r$  and two ramps of 30 minutes at about 2.3%  $P_r$ /min, up to 85% of the fuel cycle length]. The regulator obtains appropriate safety margins through multidisciplinary safety studies over all possible load transients. Before a generic licence can be issued, experiments are performed on one selected unit in order to analyse the operating experience and validate the safety margins. Once the safety margins are established and the operating licence is issued, the utility takes an engagement to operate within these margins. The operating license determines the maximum total number of load cycles, based on the original design and the type of transient (magnitude and rate of power variation, etc.).

In addition to the general license, some supplementary conditions on the fuel and state of equipment (e.g. steam generators) must be fulfilled by the plants to obtain authorisation for manoeuvring. In some situations the regulator can ask to suspend manoeuvring, for example if the physic-chemical characteristics of the core indicate a leak of a fuel element or another malfunction.

The situation in Germany is similar. Load following operation is implicitly permitted by the licenses, and has been practised since many years, in fact from the beginning of operation. License conditions describe the permitted rates of power change, the maximum frequency of power variation and further operational details. Requirements due to “conditions of safe operation” give additional constraints on load following operation, i.e. conditions arising from measures on fatigue safety. Those additional constraints may indirectly influence load following operation.

In other countries, such as the United States, regulators instead explicitly limit load following operations, in particular automatic load following through electronic signalling from the network operator. The Code of Federal Regulations in the United States thus states that *the licensee may not permit the manipulation of the controls of any facility by anyone who is not a licensed operator and apparatus and mechanisms other than controls, the operation of which may affect the reactivity or power level of a reactor shall be manipulated only with the knowledge and consent of an operator or senior operator licensed pursuant to part 55 of this chapter present at the controls* (10 CFR Part 50). Although this does not prohibit power load variations controlled by the operator, manoeuvring in an automatic regime is not authorised by current regulations in the United States.

### Summary of load following capabilities of nuclear power plants

In contrast to gas- or coal-fuelled power plants that have load following capabilities throughout their entire lifetime, the manoeuvrability of nuclear power plants varies strongly with the fuel irradiation. Manoeuvrability is maximal in the first two thirds of the irradiation cycle, and then decreases almost linearly to reach zero at 85-90% of the fuel cycle. Nuclear units cannot be used in a load following mode during the last 5-20% of the fuel cycle, depending on the reactor type.

In France, nuclear power plants do not operate in load following mode during the first 2 weeks after start-up and during the last 15% of the fuel cycle. In this last stage they only take part in frequency regulation, and essentially no power variation is allowed unless necessary for safety. At the very end of the cycle and during stretching, nuclear power plants are operated at steady power output and do not regulate or load follow until the next refuelling outage. There are other specific conditions in which cycling or regulation operation are not authorised or not commonly realised; for example, it is general practice not to carry-out load following on a large scale if fuel rod failures have occurred or if some leakages have been detected in the steam generator. Also, the in-core measuring equipment must be recalibrated at regular intervals, usually every 60-90 days: measurement equipment calibration requires that the nuclear unit had been operated at a stable power for at least 48 hours. During those periods, power cycling is clearly not possible.

The long time needed to reach full load is an argument often advocated to undermine the potential of nuclear reactors for load following. It is often underlined that at least one to two days are necessary to start up a nuclear power plant and reach full power. In reality this depends on the conditions of the



plant at start-up. For instance, one to two days are effectively needed for starting up a nuclear power plant after a refuelling or a long-term outage. However, it is worthwhile to note that it takes just about two hours to reach nearly full load starting from the hot stand-by state. This time requirement further decreases if the unit is kept running at house load, namely if the power demand of the power plant is provided by its own generator and the generator remains synchronised with the grid. Run-up to full load is then possible in less than an hour.

Finally, it is interesting to compare the main manoeuvrability parameters of gas-, coal-fuelled and nuclear power plants used for load following operations. Data from the EC and NEA previous studies are reported in Table 3.2.

**Table 3.2: The load following ability of dispatchable power plants in comparison**

	Start-up time	Maximal change in 30 sec	Maximum ramp rate (%/min)
Open cycle gas turbine (OCGT)	10-20 min	20-30%	20%/min
Combined cycle gas turbine (CCGT)	30-60 min	10-20%	5-10%/min
Coal plant	1-10 hours	5-10%	1-5%/min
Nuclear power plant	2 hours - 2 days	up to 5%	1-5%/min

Source: EC JRC, 2010 and NEA, 2011a.

### *Influence of flexibility on plant performance and lifetime*

Operating electricity production plants in a load cycling mode has an impact on the strength of some large components, on the wear and tear of plant equipment and on the constraints for the fuel element. Also, load cycling may impose additional operation and maintenance costs since it requires more frequent inspections and replacement of equipment, as well as greater needs for labours.

However, many of the effects related to load cycling may only become apparent with several years of delay and are also caused by other factors, such as the normal ageing of the plant and equipment. Also, the accrued load following operational experience is still limited, especially for nuclear units, and there are insufficient data for a statistically significant analysis. It is therefore difficult to quantify the portion of the effects observed on nuclear plants that are attributable to load following as opposed to other factors.

### *Effect on large components*

Operating in a cycling or load following mode leads to periodic variations in the coolant temperature and thus in the temperature and pressure of several components of the plant. These periodic thermal transients lead to cyclical changes in the mechanical load in some parts of the equipment, thus reducing the mechanical strength of metallic materials (fatigue). If the temperature gradient exceeds a certain level, fatigue could induce localised structural damage causing some components to creep and crack.

A recent study on the Russian AES-2006 project based on the VVER-1200 design (Mokhov and Podshibiakin, 2010) has identified the reactor components and piping elements most affected by load cycling, as shown in Figure 3.8:

- the spray line (pressuriser) and the branch pipe of the spray line;
- nozzle of the spray line to the cold leg;
- surge line;
- nozzles of the surge line (to the pressuriser and the primary loop);
- steam generator feed water inlet.

The study concludes that many load cycling regimes (specifically, frequency control operation in a  $\pm 5\% P_r$  band with ramps of  $1\% P_r$  per second and power level variations of  $10\% P_r$  with the speed of  $5\% P_r$  per minute) have no impact on the strength of components. More pronounced load variations, such as steep changes of reactor power level (up to  $\pm 20\% P_r$  with the speed of  $10\% P_r$  per minute) or load following in the power range between  $50\% P_r$  to  $100\% P_r$  (with ramping rates of less than  $5\% P_r$  per minute) are limited to 20 000 cycles in the reactor lifetime.

**Figure 3.8: VVER-1200 layout and the elements critical for the load following (red arrows)**

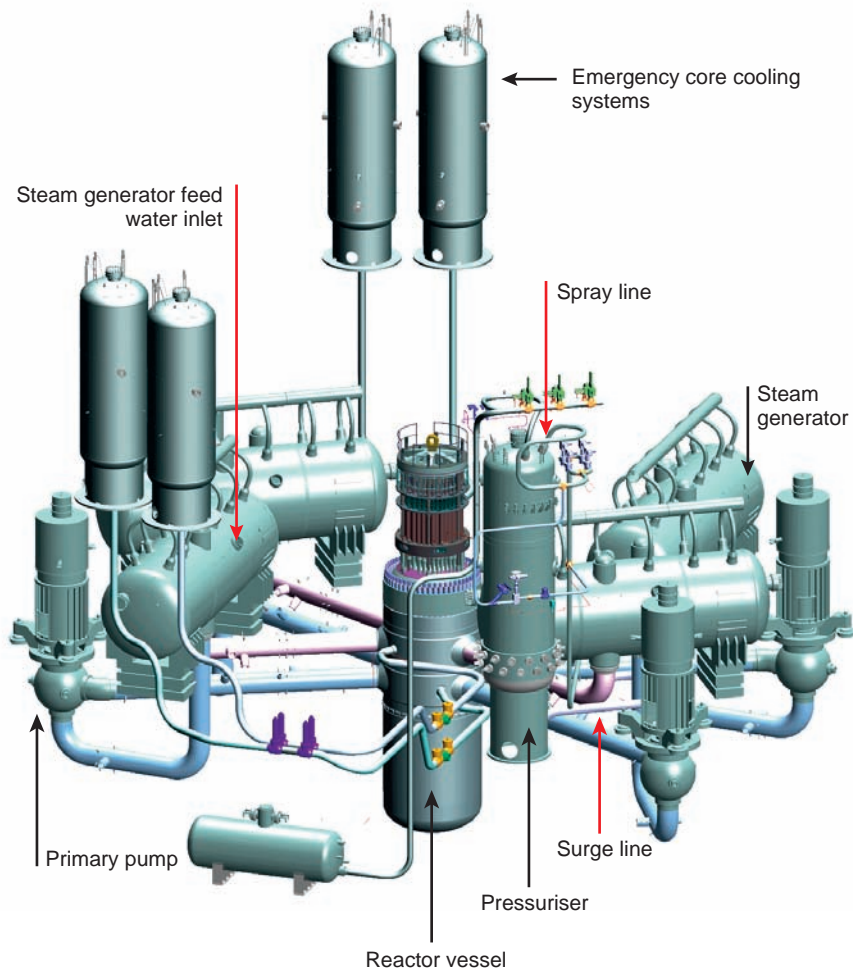

Source: NEA, 2011a; Mokhov and Podshibiakin, 2010.

The already mentioned paper by Ludwig *et al.* (2010) underlines that German nuclear power plants were already designed to withstand significant load cycling through their entire lifetime and the most sensitive equipment has been sized and designed accordingly. In addition, preventive measures, such as the automatisisation of operation control, have already been taken in order to mitigate the impact of load following on material fatigue. Continuous monitoring of equipment fatigue (temperature measurements, non-destructive material tests) is routinely performed, especially on safety-related components.

#### *Fuel performance in load following mode*

One of the most important requirements for nuclear reactor manoeuvrability is the sufficient reliability of the fuel element. Power transients induce a significant thermal and mechanical stress on the fuel pellet and on the cladding that could impair the mechanical reliability and integrity of the fuel element.

Presently, prevention against fuel rod cladding failures is one of the most important limiting factors to the frequency and extent of power variations during following operations.

According to a recent review on fuel failures in LWRs reactors (IAEA, 2010a), the major causes of cladding failure are (1) grid to rod and debris fretting, (2) corrosion, (3) pellet-cladding interaction (PCI) and (4) stress corrosion cracking (SCC). The two latter mechanisms are particularly relevant in regards to the effects of load cycling.

At full power, the temperature difference between the centre and the edge of the fuel pellet is often superior to 450/500 °C; the radial temperature gradient in the fuel pellet can exceed 100 °C/mm, which induces large internal mechanical stresses. During the first power increase to the rated power level the pellets usually fracture into several large fragments (4-8 radial sectors and 3-5 axial fragments), as shown in Figure 3.9 (a) and (b). The number of fragments is roughly proportional to the linear heat generation rate. Fuel pellet cracking significantly increases the release of corrosive fission gases into the gap between the pellet and the cladding, thus resulting in higher internal pressure and corrosion. Cladding undergoes a substantial mechanical stress during the irradiation: at the beginning of irradiation the clad is subject to a large pressure differential (coolant pressure minus internal pressure) and creeps in compression due to this load. Progressively with irradiation, the pellet-clad gap closes due to cladding creep and pellet swelling (resulting from fission product accumulation). With irradiation, the fuel pellets get progressively in contact with the cladding (PCI).

Load following operations, and more generally rapid power transients, can increase the mechanical stress on the cladding and might lead to PCI failures. The physical phenomena at the origin of PCI failure results from the different thermal dilatation between fuel pellet and clad: during power variation the pellet dilates and retracts much more quickly than the cladding. In particular, in the case of a large power increase the pellet fragments can push strongly on the cladding. The resulting excessive mechanical constraint combined with the enhanced release of highly corrosive fission gases can initiate cracks in the cladding, and lead to stress corrosion cracking (see Figure 3.9) and failure of the fuel cladding. There is a certain limit of the linear heat generating rate below which power variations are safe for the PCI, because the deviation between clad creep and pellet swelling remains within the permitted frame, and thus the fuel and cladding can adapt to the new power level (IAEA, 2010a).

Improvements in LWR fuel manufacturing and adoption of advanced operational modes that limit local power transients have considerably reduced fuel failures related to PCI. According to the last survey made by IAEA, only a limited number of PCI-related failures have been observed recently in PWR fuel, while PCI is still the second cause of cladding failures for BWR fuel (IAEA, 2010a).

Fuel manufacturing companies have developed and tested advanced fuel which has proven to be more resistant to PCI and corrosion: in particular, the development of cladding constituting of several layers of different materials (with an internal zirconium liner) has considerably reduced the rate of PCI failures. An additional mitigation method currently under development is the adoption of advanced fuel with a reduced release rate of fission products with burn-up. A change in the design of BWR fuel has lowered the linear heat rate in the rod, thus reducing the potential risk of PCI failure. In CANDU reactors, the adoption of a fuel coated with either graphite or siloxine (CANLUB fuel) has increased the fuel failure thresholds.

The newer operation modes adopted in PWR, in particular the use of boron and grey control banks for power regulation has significantly reduced the impact of power variation on local neutron flux and power distribution. Boron regulation does not affect power distribution within the core, while the “grey” control rods do not significantly perturb it.<sup>6</sup> In BWR boron cannot be used for power regulation and control rods are used for compensating the reactivity variations due to burn-up and some power variations. Fast movements of the control rods could lead to significant changes of the linear heat generation rates, especially in the fuel assembly close to the control rod. Thus, load following with the BWRs is preferably done using the recirculation pumps, which has a very limited impact on the power distribution in the core.

6. The efficiency of a black control rod is about twice that of a grey one. The introduction of grey rods thus reduces the local thermal flux and power by 25%, compared with a value of 50% for black rods.

According to reported French experience, daily load cycling and extended reduced power operation, together with the associated control rods movements, do not affect the rate of fuel failures (Provost and Debes, 2006; IAEA, 2010a). A similar statement was made for German NPPs (Ludwig *et al.*, 2010).

In the case of isolated fuel failures, the coolant purification system is designed to remove radioactive material from the primary circuit, without requiring a shutdown of the plant; this device has effectively limited the impact on personnel and on the environment to acceptable levels. It is general practice to not carry out load cycling operations if fuel rod failures have occurred.

**Figure 3.9: Cracking of some PWR fuel pellets**

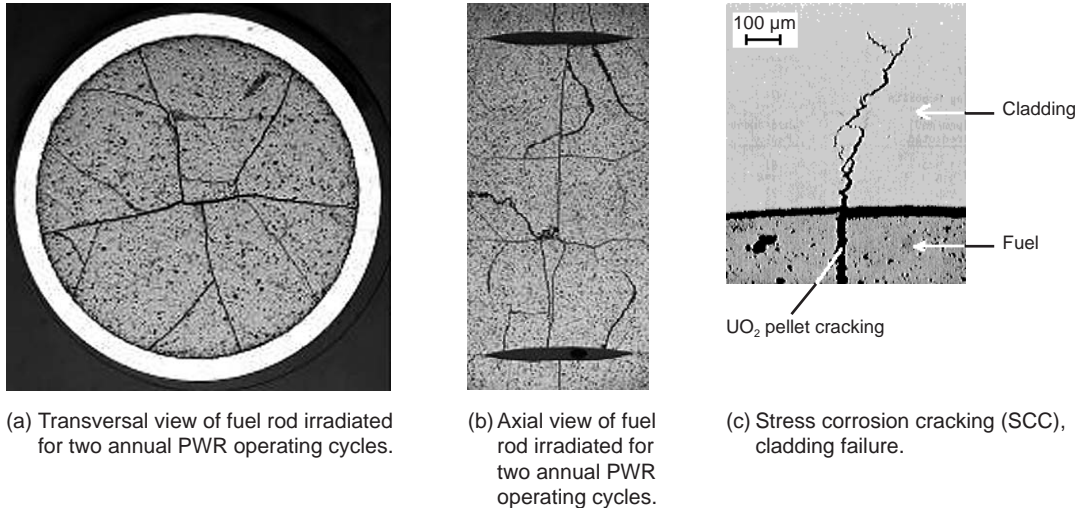

Source: Brochard *et al.*, 2001.

### Impact on operation and maintenance

Cycling operations require more frequent use of some active components (control rods, valves, pumps, chemical and volume control system, etc.) that are subject to accelerated corrosion and wear and tear. Generally, these are not safety-related equipment and are monitored and easily replaced during standard maintenance operations. Safety-related systems that are not easily replaceable such as control rods are designed to withstand increased use due to cycling operations.

EDF recently conducted a study aiming to quantify the loss of production due to additional outages that could be related to load following operations (EC JRC, 2010). Ten nuclear power plants operated in a load following mode are compared with ten others that have been operated in a baseload mode, allowing only primary frequency control. The statistical analysis performed over several years of operating experience showed that load cycling reduced the availability factor of those plants by 1.8%. The reduction in availability factor was related to extended maintenance required by the chemical and volume control system. Other sources quantified the loss of availability factor in French nuclear power plants due to load following at 1.2%; similar values have been reported in Pouret and Nuttall (2007).

The European Commission has performed a detailed statistical analysis (EC JRC, 2010) on the relationship between availability and load following operations for nuclear plants operated in 27 countries of the European Union and Switzerland, based on the publicly available IAEA Power Reactors Information System (PRIS) database. Nuclear units with a very low participation in load following have, on average, a lower amount of equipment outage. In particular, a correlation has been observed for the outages related to the three systems that could be impacted by load cycling operations: safety systems reactor instrumentation, control system and auxiliary system. No correlation has been observed between cycling operations and outages related to other systems. The study concludes that the increased outage need due to load following can be estimated as 20 hours per year for each of the 3 systems involved

(with a 100% standard deviation). The amount of hours lost due to extended maintenance is therefore between 60 and 120 hours, which represents a loss of 0.7-1.4% of the availability factor. Additional studies performed by EPRI and a Slovakian operator concluded that load cycling should have an impact on O&M, but no statistically significant effects were observed.

### **Economic aspects of load following**

Load following allows operators to adapt to periods of low demand and to avoid supply exceeding demand with the consequence of precipitous price declines. The economic aspects of load following have received increased interest due to the extreme price volatility induced by variable renewables (including negative prices) in countries with large shares of renewables, such as Germany.

However, there are, of course, costs as well as benefits related to load following. The cost increase due to load following operation is related to several factors: (a) additional and more stringent requirements for the plant design, the monitoring system and the fuel element design; (b) increased operation and maintenance expenses since the plant's components need more frequent inspections and repairs; and (c) income losses due to the reduction of the plant's load and availability factor.

According to current utility requirements, new nuclear power plants should already have implemented in their design strong manoeuvrability capabilities, including operation in a load following mode. The load following option is therefore already "built-in" in the reactor design and it does not cause additional investment costs. Also, a number of older nuclear units have already been designed for significant manoeuvring capabilities or have already been upgraded to improve their operating flexibility; no investment or limited investment are thus required to exploit those units in a load following mode. Thus if one considers only new or modern nuclear units, it seems reasonable not to consider additional investment costs for load following capabilities, since they can be considered sunk costs, regardless of the choice of operating mode. Similar reasoning can be applied to fuel elements: the additional requirements for fuel design are already priced into the fuel cost, regardless of the operational mode of the reactor.

A different aspect is the accelerated ageing of the plant and a potential reduction of its lifetime. According to AREVA, EDF and the French regulatory authority, there is today no clear evidence that load following will accelerate the ageing of NPPs, and only a very small number of pieces of equipment could be adversely affected (Pouret and Nuttall, 2007). If load variations are performed within design specifications (in terms of extent and frequency of load modulations) the operational lifetime of the power plant should not be affected.

Estimating the increase in operation and maintenance cost associated with load following is extremely difficult and controversial, and not only for nuclear power plants. As reported in (EC JRC, 2010) several EPRI studies attempted to assess the impact of load cycling on conventional (coal, oil and gas) power plants in the United States. Those studies determined some correlation between operations at variable load and an increase in O&M needs, but were unable to quantify the associated cost. For nuclear power plants, the major economic impact of load following operations is certainly the decrease of the availability rate, due to longer outages for maintenance. As seen in the previous section, a reduction on the availability factor of 0.7-1.4% could be attributed to load cycling operations in the French nuclear park.

In the French and German experience, daily load cycling and extended reduced power operation, together with the associated control rod movements, do not affect the rate of fuel failures and therefore do not represent an additional cost to the operator. It is sometimes mentioned that the adoption of flexible operations could cause a suboptimal utilisation of nuclear fuel and a consequent increase in fuel costs. However, more advanced operational modes can smooth the variations in the neutron flux that is associated with load following and therefore limit the impact on fuel burn-up. In addition, a small degradation of the average fuel burn-up has only a limited impact on the overall cost of electricity production, owing to the low share of fuel costs for nuclear energy.

From an economical viewpoint, lost production hours represent the larger cost associated with load following, either due to primary and secondary regulations or to daily and weekly load following. The plants involved in primary and secondary regulation must reduce their operating power by the margin that may be called upon by the grid (in France, this is 2% for primary frequency control and 5% for

secondary frequency control); this translates directly into a reduced load factor. A nuclear plant ensuring both primary and secondary frequency control would have a load factor about 7% lower than one working in normal baseload conditions. Daily and weekly load following also causes a significant reduction in electricity generated: the adoption of a 12-3-6-3 load pattern over the whole cycle would reduce the load factor by more than 18%. Similar load factor reductions (between 12% and 18%) are observed for other widely used load patterns.<sup>7</sup> In practice, however, only a fraction of a nuclear fleet participates simultaneously in load cycling; the overall load factor decrease is much lower if averaged over the entire nuclear park. In France, the amount of lost hours due to load following for the 57 French nuclear plants is 62 hours per year, on average (EC JRC, 2010). This corresponds to a reduction of load and availability factors of 0.7%.

The electricity wholesale market price in 2012 on the Europe EEX for a one-year forward contract was EUR 57/MWh for baseload, EUR 71/MWh for peak-load and EUR 50/MWh at off-peak.<sup>8</sup> If one considers a nuclear power plant of 1 400 MW, the electricity production lost due to primary and secondary frequency control implies a gross cost of about EUR 135 000 per day.<sup>9</sup> The total value of the electricity lost due to daily load following (including economically motivated load following to avoid prices below marginal costs) can be estimated as high as EUR 250 000 per day. In addition to these direct costs, one should also consider the decrease of the availability of the nuclear power plant that is attributable to load cycling operations: the associated cost can be estimated in the range of EUR 5 to 10 million per year.

Finally, it is useful to quantify the impact of load following on the LCOE for the four major generating technologies; results are based on the joint IEA/NEA study *Projected Costs of Generating Electricity* (IEA/NEA, 2010).<sup>10</sup> Table 3.3 summarises the LCOE increase for the most commonly used load following options: primary frequency control with a 2% margin, secondary frequency control with a 5% margin, a combination of both primary and secondary frequency control and a typical daily load following pattern, with a 15% reduction of the load factor.

As expected, the impact of reduced load factor on generating prices is more significant for capital intensive technologies such as nuclear than for coal or gas.

**Table 3.3: Production cost increase due to load following**

	LCOE increase (%)					
	5% interest rate			10% interest rate		
	Nuclear	Coal	Gas	Nuclear	Coal	Gas
Primary regulation	1.7	0.7	0.3	1.8	1.0	0.5
Secondary regulation	4.4	1.9	0.9	4.8	2.5	1.2
Primary and secondary regulation	6.3	2.7	1.2	6.8	3.6	1.7
Daily load following	14.8	6.2	2.9	16.0	8.3	3.9

Source: IEA/NEA, 2010.

7. It is interesting to note here that, if frequency control and daily load following both reduce load factor, those reductions have a different economical impact for the electricity producer. Frequency control implies an electrical output reduction during the whole day, at peak hours when the electricity is valuable and at night-time, when the demand for electricity is low. On the other hand daily and weekly load following reduces the electrical output only at low-demand periods, when electricity value is low.

8. These figures are obtained as average of electricity Phelix futures in August and September 2011.

9. Net costs may be lower due to country-specific arrangement with the network operator for the provision of a certain number of network services.

10. See Section 3.2 for additional information on the LCOE methodology. For consistency, direct and indirect O&M cost increase was not accounted for.

### *The economic value of price-induced load following*

The purpose of the present analysis is to assess the economic value of price-induced load following, i.e. the ability of a power plant to cease electricity production when market prices falls below the production cost and to resume production when economically profitable. Peak-power plants such as reservoir-hydro, oil- and gas-fuelled thermal plants are regularly exploited in this mode, operating only when electricity prices are sufficiently high. However, the recent increase in price volatility and the extent of periods with very low (and even negative) electricity prices has raised the question whether technologies traditionally considered as baseload could also have an economical interest in this operational mode, especially since the increasing share of variable renewable sources is expected to exacerbate the volatility in the near future.

As shown in previous studies (NEA, 2011b) the value of load flexibility increases significantly with the production costs: generating technologies with higher variable costs are more likely to defer production in response to low electricity prices, thus avoiding long periods with negative margins. This is the case for gas-fired power plants that can operate profitably even with average annual prices lower than variable costs. The likelihood that more capital intensive technologies such as nuclear with lower variable costs could see market prices lower than their variable costs and hence modulate load as a function of prices is therefore more limited. Nevertheless, recent evidence, in particular from Germany, suggests that this is increasingly the case.

While electricity price volatility and the marginal cost of production are the key drivers for the profitability of price load following, the ramping rate, the minimal power level achievable and the cost associated with load transients also play an important role. The present analysis is based on daily market data from EEX, the largest European electricity exchange operator. The available data cover the period between first January 2005 and the end of July 2010. An initial simplified case evaluates the potential benefits of load following of an ideal electricity generator that has no technical or economical constraints. The second analysis introduces additional operational constraints such as a minimum load level and limits on the speed of the power ramp rates. Of course, this exercise only applies to the highly volatile day-ahead spot price. Prices in the electricity forward markets, in which a substantial share of electricity is traded, include some measure of capital costs, display much more stable price curves and do not offer any scope for economic load following.

**Figure 3.10: Daily electricity prices on the EEX during 2005-2010**

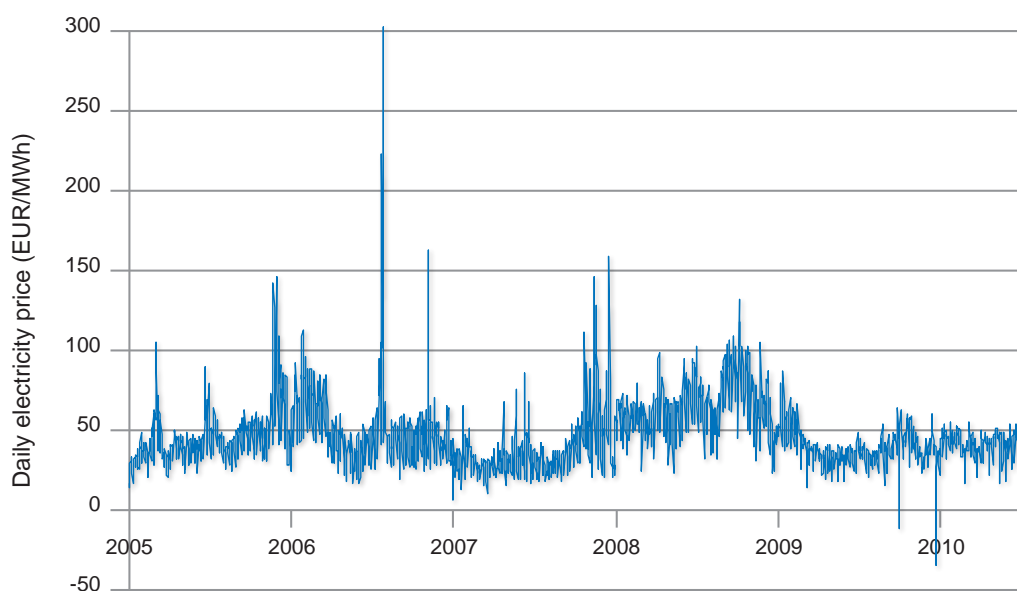

Source: Based on EEX data.

The trend of daily electricity prices on the EEX is presented in Figure 3.10 for the 2005-2010 period. The principal market data, maximum, minimum and yearly average prices, hourly volatility as well as hours with negative prices are reported in Table 3.4. The period analysed has been characterised by a large variability in electricity prices, driven by large changes in the raw material prices, the introduction in Europe of a carbon pricing mechanism and by large variations in the demand curve due to the economical crisis of 2008-2009. As expected, hourly intraday prices show even higher volatility, with prices that exceeded EUR 1 000/MWh and negative prices as low as EUR -500/MWh. While overall volatility has been reduced in recent years, since 2008 electricity has been traded at negative price, for a significant time (about 0.8% in 2009).

**Table 3.4: Summary of hourly prices in the EEX day-ahead market<sup>11</sup>**

	2005	2006	2007	2008	2009	2010*
Average electricity price (EUR/MWh)	46.0	50.9	38.0	65.8	38.9	42.0
Maximum price (EUR/MWh)	500.0	2 436.6	821.9	494.3	182.1	88.1
Minimum price (EUR/MWh)	0.0	0.0	0.0	-101.5	-500.0	-18.1
Standard deviation (EUR/MWh)	27.2	49.5	30.4	28.7	19.4	12.8
Hours with negative prices	0.0	0.0	0.0	15.0	71.0	10.0

\* Data for 2010 are available only until 30<sup>st</sup> July.

As previously mentioned, we initially evaluated the potential benefit of load following for an “ideal” electricity generator that could immediately cease electricity production in response to a spot price signal inferior to its production cost, and go back instantaneously to full power when selling electricity becomes profitable. In other words, the “ideal” generator has a minimal power plant load of 0 and an infinite ramping rate. No additional cost is associated with load following operations.

For each year, we calculated the operating profit for a power plant operating steadily at full power with an availability factor of 85%; this is representative of a typical baseload power plant with no load following capabilities. Operating profit for this plant is simply the difference between average yearly price and the marginal cost of production. Operating profit has also been calculated as a function of the production cost for an “ideal” generator which could cease production when it is economically not attractive produce electricity. The economical value of load flexibility is simply the difference between the above figures. Finally, we estimated the operating profit increase due to load following, as a function of the production cost. Results are summarised in Table 3.5 and illustrated in Figure 3.11.

Technologies with high variable costs (such as gas-fuelled power plants) benefit the most from load following. In addition, lowering the load factor does not significantly impair profitability, due to low fixed capital costs. For a unit with a production cost of EUR 40/MWh, load modulation would have increased the operating profit by 76% in comparison to a unit operated in a baseload mode. Load modulation allows those plants to be profitable even when average electricity prices fall below their production cost.

In the case of capital intensive technologies, the increase of operating profitability due to load flexibility is rather limited: for a generator with a production cost of EUR 10/MWh, load flexibility would increase the operating profit by 0.5% on average over the 2005-2010 period. The corresponding figure for a variable production cost of EUR 15/MWh is approximately 1%. Of course, this underestimates the true financial benefit of economic load following both to the operator itself as well as to the industry as a whole. Every time a nuclear plant stops because its variable costs are higher than price, prices will have a tendency towards stabilisation which will benefit all participants.

11. The EEX day-ahead market has since been transferred to the Franco-German EPEX SPOT market.

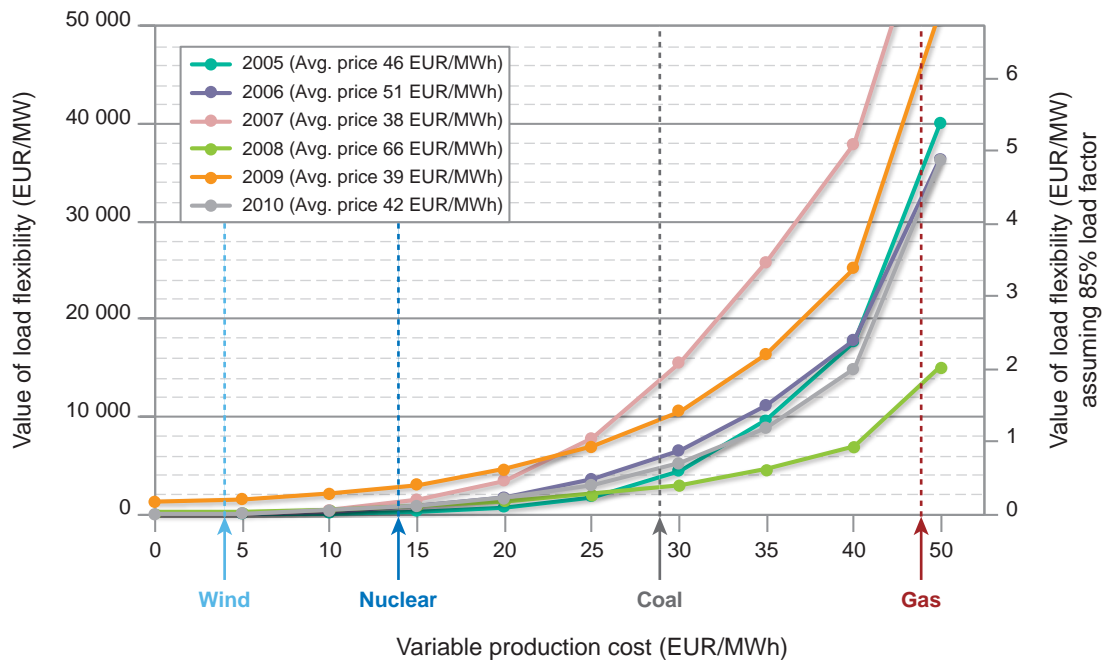

**Table 3.5: The benefits of economic load following as a function of different variable costs**

		Variable production cost (EUR/MWh)									
		0	5	10	15	20	25	30	35	40	50
2005	Hours with prices below variable production cost	0	28	69	133	332	817	1 828	3 117	4 312	6 160
	Operating profit for baseload operations (EUR/MW)	342 335	305 105	267 875	230 645	193 415	156 185	118 955	81 725	44 495	-29 965
	Operating profit with load following (ideal) (EUR/MW)	342 335	305 162	268 126	231 300	194 935	159 916	128 190	101 487	80 189	50 698
	Value of load flexibility (ideal) (EUR/MW)	0	57	251	655	1 520	3 731	9 235	19 762	35 694	80 663
	Operating profit increase	0.0%	0.0%	0.1%	0.3%	0.8%	2.4%	7.8%	24.2%	80.2%	n.a.
2006	Hours with prices below variable production cost	0	66	180	354	612	1 107	1 757	2 680	3 615	5 150
	Operating profit for baseload operations (EUR/MW)	378 151	340 921	303 691	266 461	229 231	192 001	154 771	117 541	80 311	5 851
	Operating profit with load following (ideal) (EUR/MW)	378 151	341 080	304 370	268 272	233 055	199 504	168 223	140 374	116 615	79 463
	Value of load flexibility (ideal) (EUR/MW)	0	160	679	1 811	3 824	7 504	13 452	22 833	36 304	73 612
	Operating profit increase	0.0%	0.0%	0.2%	0.7%	1.7%	3.9%	8.7%	19.4%	45.2%	125.2%
2007	Hours with prices below variable production cost	0	123	293	656	1 319	2 901	4 309	5 310	5 998	7 037
	Operating profit for baseload operations (EUR/MW)	282 829	245 599	208 369	171 139	133 909	96 679	59 449	22 219	-15 011	-89 471
	Operating profit with load following (ideal) (EUR/MW)	282 829	245 897	209 519	174 358	141 144	112 603	91 033	74 348	61 328	42 776
	Value of load flexibility (ideal) (EUR/MW)	0	297	1 150	3 219	7 234	15 924	31 583	52 129	76 338	132 247
	Operating profit increase	0.0%	0.1%	0.6%	1.9%	5.4%	16.5%	53.1%	234.6%	n.a.	n.a.
2008	Hours with prices below variable production cost	15	103	145	198	267	375	608	913	1 358	2 540
	Operating profit for baseload operations (EUR/MW)	490 960	453 628	416 296	378 964	341 632	304 300	266 968	229 636	192 304	117 640
	Operating profit with load following (ideal) (EUR/MW)	491 325	454 315	417 522	380 923	344 576	308 615	273 322	239 244	206 693	148 470
	Value of load flexibility (ideal) (EUR/MW)	365	687	1 226	1 959	2 943	4 315	6 354	9 608	14 389	30 829
	Operating profit increase	0.1%	0.2%	0.3%	0.5%	0.9%	1.4%	2.4%	4.2%	7.5%	26.2%
2009	Hours with prices below variable production cost	71	199	361	577	845	1 392	2 219	3 377	4 927	7 083
	Operating profit for baseload operations (EUR/MW)	289 292	252 062	214 832	177 602	140 372	103 142	65 912	28 682	-8 548	-83 008
	Operating profit with load following (ideal) (EUR/MW)	291 953	255 346	219 256	184 029	149 796	117 281	87 580	61 948	42 468	20 622
	Value of load flexibility (ideal) (EUR/MW)	2 661	3 284	4 424	6 428	9 424	14 140	21 668	33 266	51 016	103 630
	Operating profit increase	0.9%	1.3%	2.1%	3.6%	6.7%	13.7%	32.9%	116.0%	n.a.	n.a.
2010*	Hours with prices below variable production cost	10	49	100	166	286	489	764	1 286	2 043	3 778
	Operating profit for baseload operations (EUR/MW)	180 591	159 069	137 547	116 025	94 503	72 981	51 459	29 937	8 415	-34 629
	Operating profit with load following (ideal) (EUR/MW)	180 620	159 244	138 032	117 090	96 471	76 579	57 657	40 415	25 855	7 553
	Value of load flexibility (ideal) (EUR/MW)	29	175	485	1 065	1 968	3 598	6 198	10 479	17 440	42 183
	Operating profit increase	0.0%	0.1%	0.4%	0.9%	2.1%	4.9%	12.0%	35.0%	207.3%	n.a.
2005-2010 average	Hours with prices below variable production cost	16	95	191	347	610	1 180	1 914	2 781	3 709	5 291
	Operating profit for baseload operations (EUR/MW)	327 360	292 731	258 102	223 473	188 844	154 215	119 586	84 957	50 328	-18 930
	Operating profit with load following (ideal) (EUR/MW)	327 869	293 507	259 471	225 995	193 329	162 416	134 334	109 636	88 858	58 264
	Value of load flexibility (ideal) (EUR/MW)	509	777	1 369	2 523	4 486	8 202	14 748	24 679	38 530	77 194
	Operating profit increase	0.2%	0.3%	0.5%	1.1%	2.4%	5.3%	12.3%	29.0%	76.6%	n.a.

\* Data for 2010 are available only until 30<sup>st</sup> July.

Figure 3.11: Value of load flexibility



#### Price-induced load following with minimum load requirements and ramp cost

In addition to the unconstrained case discussed above, the study analyses a case that takes into account two operational limitations to load modulation, namely the minimal plant load and the speed at which the load can be changed (ramp rate). A parametric study was realised for the year 2009 considering different levels of minimal plant load (0%, i.e. the ideal case, 25%, 50% and 75%). In addition, five different ramping rates were considered: 1%, 3%, 5%, 10% and the aforementioned ideal case with an infinite ramping rate. Results are shown in Figure 3.12.

The more important factor affecting the economical profitability of load modulation is the minimal power level that a generator can reach; the economic value of load modulation is nearly proportional to the difference between maximal and minimal load. The economic incidence of the ramping rate is marginal: doubling the ramping rate from 5% to 10% would lead to a 2.5% increase in the load flexibility value.

The economical incentive of implementing a flexible load in response to market-price signals is rather limited for a technology with low production cost, such as nuclear energy. If one assumes a nuclear unit of 1 000 MW that could reduce the power output by 50% in response to an electricity price inferior to EUR 15/MWh the increase in operating profit over the 2005-2010 period would have been approximately EUR 7 million. However, the net economical benefit should include also additional costs due to load following operations: costs due to the increase in outage rate can be estimated in a range of EUR 3 to 5 million.

While these conclusions refer to the 2005-2010 period, the expansion of generating capacity with variable renewable is likely to increase the volatility of electricity prices and thus boost the economic value of price-induced load following. On the other hand, larger and more interconnected markets, and the adoption of more flexible operations in generating power plants would reduce the need for, and thus the economic benefit of, load following. Nevertheless, one should not forget that increasing load following to mitigate the pecuniary system effects induced by variable renewable is not neutral with respect to prices; rather it has a stabilising effect on prices and dampens volatility. Empirical evidence shows how the flexibility of all conventional technologies (gas, coal and nuclear) buffers the price effects of intermittency, stabilising revenues for all concerned. Short-term load following is part of providing back-up sources. The chapter thus also underlines the need for better defining the notions of flexibility

and back-up in electricity markets. In the future, OECD countries will also need to define rules for allocating costs between those that create the intermittency, the private providers who are affected by it, and the general public, who will have to weigh the short-term benefits in terms of average prices against the long-term risks of declining conventional capacity and electricity supply interruptions.

**Figure 3.12: Value of load flexibility in 2009 for a production cost of EUR 15/MWh**

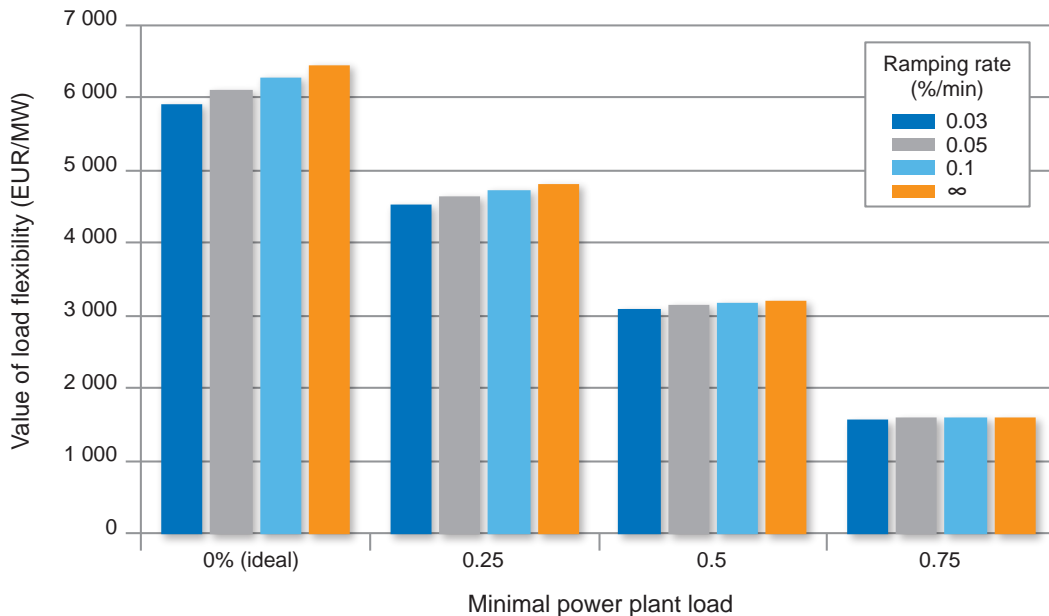

### 3.2 Long-term management of nuclear power plant fleets to minimise system costs

The regular shutdown of nuclear power plants for re-fuelling and maintenance imposes externalities (grid-level system effects) on the electricity system and other operators in the form of added adequacy costs. Good management of planned nuclear outages and co-ordination between the grid operator and electricity producers can substantially reduce these grid-level system effects and facilitate the integration of nuclear power into the grid. In this respect, the presence of a large nuclear fleet adds operational constraints and complexity but also allows for additional flexibility.

#### Outages of nuclear power plants

Operational nuclear power plants must regularly shut down for refuelling needs, normal maintenance and routine reviews of plant operation. Special safety reviews are also scheduled following major operational events. These routine and reactive safety reviews are generally focused reviews and do not consider changes in safety standards and operating practices, the cumulative effects of plant ageing, plant modifications, feedback of operating experience and developments in science and technology. In order to address these potential impacts on plant safety, the safety authorities of many countries require a comprehensive, integrated safety review, commonly referred to as a periodic safety review (PSR), to be conducted every ten years.<sup>12</sup>

12. Refuelling, routine, special and periodic safety reviews can generally be anticipated and planned several weeks/months in advance, leaving the plant operator some margin for co-ordination with energy authorities and technical-economical optimisation. IAEA defines planned outages as those that can be anticipated and planned at least four weeks in advance. Unplanned outages are all unanticipated events that cause or prolong the disconnection of the nuclear plant to the grid: major causes of unplanned outages are plant equipment problems or failures, human-related fault and unanticipated requirements from safety authorities. Extension of planned outages, i.e. the increase of outage duration beyond the planned time, is also an important contributor to unplanned outages.

During these operations, the nuclear power plant is shut down and disconnected from the grid: significant resources are spent at the plant, and replacement power must be provided to meet the utility's supply obligations. Planning, organisation and management of a nuclear fleet is a complex task which encompasses different factors such as technical and engineering constraints, safety and regulatory requirements, co-ordination of available resources, forecast of electricity market needs as well as other financial considerations. Reducing the duration and optimising the schedule of planned outages and minimising the unplanned shutdowns are key factors for nuclear power plant profitability.

### *Planned outages in an NPP*

The majority of reactors actually in operation have a pressure vessel enclosing the reactor core, which requires plants to be shut down during refuelling.<sup>13</sup> At each refuelling it is therefore necessary to shut down the nuclear plant in order to open the vessel, access the fuel elements and replace the most irradiated with fresh ones. During the refuelling process, all assemblies are moved into a new location in the core according to a well-established "load pattern".

Two approaches are commonly used to transition the fuel from the old configuration to the new configuration. The "full core offload/reload" approach consists of emptying the core entirely of all fuel bundles. Once the core has been emptied, maintenance work can take place within the core internals. Following completion of maintenance work, all fuel bundles are loaded back into the core in the new configuration and the vessel head is re-attached. The "fuel shuffle" approach consists of keeping the bulk of the fuel bundles within the core while moving them to their new core locations in preparation for the next cycle of operation. In this strategy, the shuffle is broken into two phases, where the first phase is used to remove fuel bundles from the core in order to open up "holes" that are needed to support the maintenance work, and the second phase is used to complete the fuel bundle relocation process.

Depending on the size of the core, the type of containment building and the total number of assemblies, the "fuel shuffle" strategy can reduce the length of an outage by as much as a week, relative to the time needed to perform a "full core offload/reload". For instance BWR, whose cores contain as many as 800 fuel bundles, routinely perform "fuel shuffles" while the majority of PWR, whose cores typically contain fewer than 200 fuel assemblies, routinely perform "full core offloads/reloads".

The length of an outage for a simple refuelling varies significantly among nuclear power plants and operators, but normally can be completed within the range of 1 and 3-4 weeks. However, in order to minimise the global outage of the plant, the majority of nuclear operators combine refuelling with routine, extended or special maintenance operations.

*Routine reviews* of NPP provide for testing of equipment that cannot be monitored during operation and for inspection of different components, structures and safety devices. For example, performance testing on transformers is usually done at each outage, while periodic inspection of the turbine and generator are scheduled every five or more years. During routine reviews, preventive and corrective maintenance work is carried out by replacing some equipment that needs to be updated or exchanged.

*Special safety reviews* are conducted following major events of significance to safety and are usually self-initiated by the licensee or may be requested by the authorities. These reviews may include refurbishment or plant back-fitting as well as some major modifications, such as the replacement of the steam generator. Duration of outages for refuelling and standard or special maintenance varies significantly depending on the amount of work required and on national regulations. The outage length ranges from 2-3 weeks to several months, with an average range of approximately 50-60 days.

The periodic safety review is a comprehensive, integrated assessment which provides a complete picture of the plant safety status at a fixed point in time, taking into account the cumulative effects of plant modifications and ageing as well as changes in safety standards and technology. PSRs are considered an effective way to obtain a precise picture of the condition of the reactors and an overall

13. CANDU and RBMK type reactors have pressure tubes that can be disconnected individually, which therefore allows for refuelling under load.

view of actual plant safety. This information can then be used to determine reasonable and practical modifications that should be made in order to maintain a high level of safety, and to improve the safety of older nuclear power plants to a level approaching that of modern plants.

### *Unplanned outages in an NPP*

Major causes of unplanned outages are plant equipment problems or failures, human-related fault and unanticipated requirements from the safety authorities. Extension of planned outages, i.e. the increase of outage duration beyond the planned time, is also an important contributor to unplanned outages. Finally, unplanned outages could be due to causes beyond plant management's control, mainly because of grid failure or unavailability, unfavourable environmental conditions or problems with the electricity market. These outages are referred to as "external".

Outage extension has a negative effect as it not only reduces energy output but also requires additional manpower and increases total outage cost. Finally, outage extension may result in the production of additional radioactive waste and hence increase the collective dose exposure. With the increase of NPP operating experience, the frequency and the length of outage extensions has been significantly reduced.

Figure 3.13 shows the distribution of energy losses in NPP between 2006 and 2010. Two thirds of the production losses in nuclear power plants were due to planned outages for refuelling and maintenance. About one fourth was due to unplanned outages, mainly as a result of problems or failures of plant equipment. About one third of these unplanned outages derive from outage extension, while human related failures accounts for less than 5% of total unplanned outages. Finally, about 6% of the production losses were due to factors external to the plant and therefore beyond plant management control, such as grid problems and failures or adverse atmospheric conditions.

**Figure 3.13: Energy loss distribution in NPP (2006-2010)**

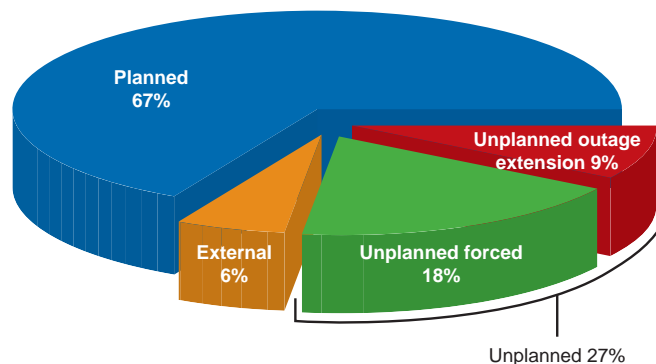

Source: WNA, 2012.

### *Operating performances of NPPs*

In the last 20 years, the electricity produced globally by nuclear power plants has increased by more than 1.6% per year, from 1 890 TWh produced in 1990 to 2 630 TWh in 2010. This implies that with essentially similar capacity nuclear has provided a greater contribution to the adequacy of the electricity supply. This increase is the result of both an increase in nuclear capacity and improvements in operational performances of nuclear power plants. Overall installed nuclear capacity rose from 318 GW in 1990 to 375 GW in 2010, with an average annual increase of 0.8%. Connection of new power plants to the grid accounts for more than 82% of that increase, while the remaining 18% of added capacity is due to power uprates of existing power plants. In absolute terms, improved operating performances correspond to an additional capacity of 10 GW. Figure 3.14 illustrates these trends.

Operating performances of nuclear power plants have steadily increased over recent decades; in the last 20 years, availability and load factors<sup>14</sup> of existing power plants have increased on average by 12% and 16%. Improvements in the conception and design of new plants and adoption of advanced and on-line maintenance operations have reduced the frequency and length of unplanned outages. Also, adoption of longer fuel cycles, and improvements in management of refuelling and standard maintenance operations have shortened refuelling operations. Currently, the average availability factor is about 81%, and is superior to 85% in more than half of all nuclear power plants.

**Figure 3.14: Historic trend of nuclear capacity and electricity production**

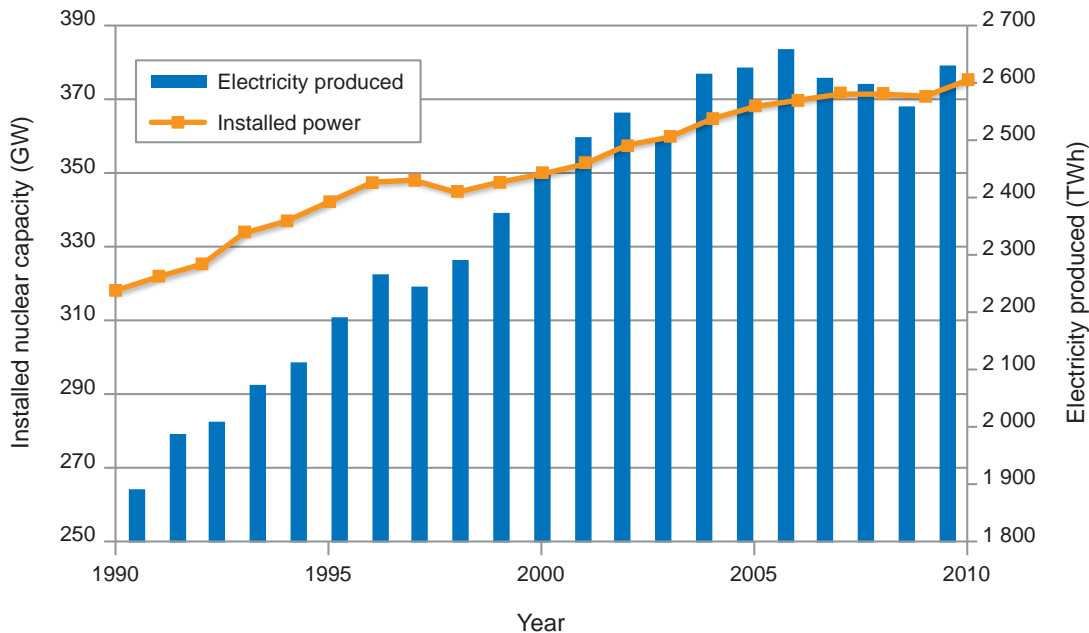

Source: Based on IAEA Power Reactors Information System (PRIS) database.

However, after a substantial growth from the 1980s to the beginning of this century, operating performance has levelled off in the last decade (details are shown in Figure 3.15). This may be partially explained by a series of external events that caused several nuclear units to enter long-term shutdown in recent years.<sup>15</sup> Also, at the current high operating factors, each incremental improvement becomes more difficult and expensive to achieve, thus limiting the potentials for further improvements in load and availability factors. If only the top 10% performing nuclear units are considered, the average availability factor reached 94% in the 2000-2010 period. This value can be considered as a limit for modern nuclear power plants.

14. Load factor is simply the electricity effectively produced by a power plant in a given reference period divided by the electricity that would have been generated if the plant operated continuously at the reference power during the entire reference period. Available energy factor takes into account not only the electricity effectively produced by the plant but also that which has not been produced due to limitations in demand (load following, for example) or to problems in the electrical grid. For a baseload electricity supplier such as nuclear, the value of the load factor and the availability factor are usually close.

15. In Japan, 17 nuclear units of TEPCO had a long term shutdown in 2003 and 2004. In July 2007, the earthquake at Kashiwasaki Kariwa caused the shutdown of seven power plants, BWR and ABWR; two units resumed operations in 2009 and two in 2010. Also, in March 2011, the earthquake and tsunami caused the permanent shutdown of four units at the nuclear site of Fukushima Daiichi and the temporary shutdown of several nuclear power plants in Japan. In Europe, two BWRs were shut down in Germany in 2008 and 2009. More recently, following the Fukushima Daiichi accident, eight units have been permanently shut down in Germany.

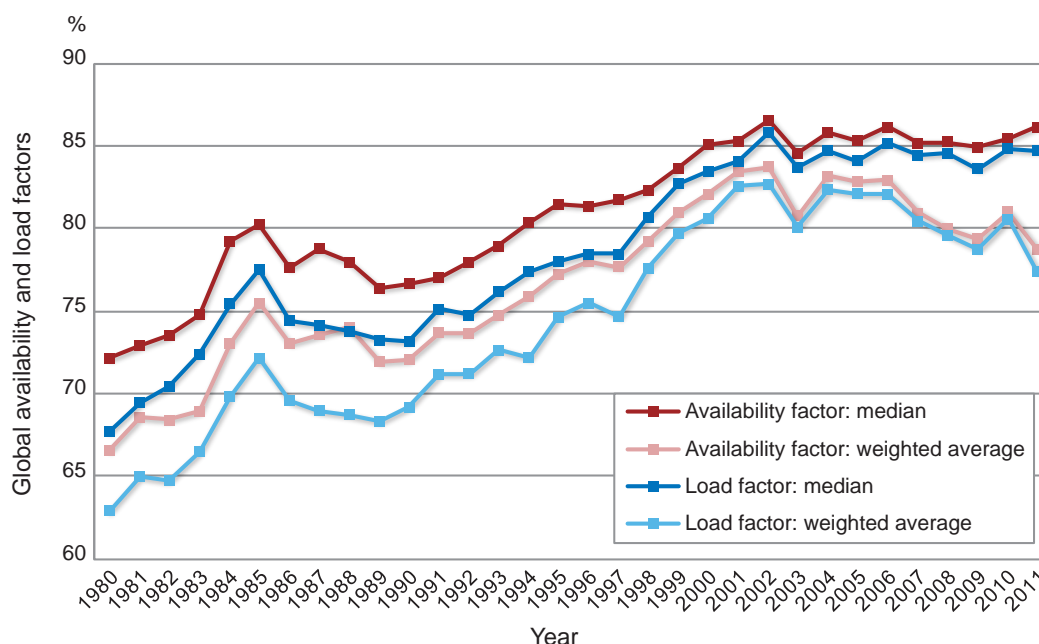
**Figure 3.15: Evolution of load and availability factors in the 1980-2011 period**

Source: Based on IAEA Power Reactors Information System (PRIS) database.

From an economical viewpoint, the load factor has a significant impact on the economics of power generation, as it defines the amount of electricity that will generate revenues to cover investment costs as well as fixed and variable operational costs. High load factors are particularly important for capital-intensive technologies such as nuclear, coal with carbon capture and storage (CCS) and most renewables.

A simple and widely used indicator of electricity generation cost is LCOE, which calculates the unit electricity production cost of different technologies over their economic lifetime. LCOEs for different technologies were evaluated in the joint IEA/NEA study *Projected costs of Generating Electricity* (IEA/NEA, 2010) for many OECD and some non-OECD countries. The following analysis is based on the “median” case, as defined in the IEA/NEA report: median data are used for investment costs, fuel prices, operations and maintenance (O&M) and decommissioning costs and a CO<sub>2</sub> price of USD 30/tonne is assumed. Figure 3.16 shows the cost structure for the main baseload technologies as well as wind.

Total investment costs represent between 60% and 75% of the total cost for nuclear production, while variable cost accounts for only 10-16% (in the case of nuclear, O&M costs are essentially fixed). An even more pronounced trend is observed for variable generating technologies such as wind, where investment costs represent an even higher share of total costs and there is no fuel cost. As a result, the marginal cost of nuclear and wind is very low, which places those technologies at the bottom of the merit order. Conversely, variable costs represent the major share of production cost in gas-fired and coal power plants: 75-80% and 60-70%, respectively.

The influence of load factor on electricity generation cost is shown in Figure 3.17; results support the intuition that load factor is more important for technologies with higher fixed costs. An increase of load factor from the reference value of 85% to 90% would reduce the generation cost for nuclear power plants by as much as 3.4%; the same variation would have a lesser effect on a gas-fuelled plant, leading to a 0.6% decrease in electricity production cost. Conversely, a reduction of the load factor from 85% to 75% would impact much more severely a nuclear than a gas electricity producer: the respective production cost increases would be 7.8% and 1.5%. Similar and even more pronounced figures are obtained if a discount rate of 10% is chosen.

**Figure 3.16: Electricity generation cost for baseload and wind power plants**

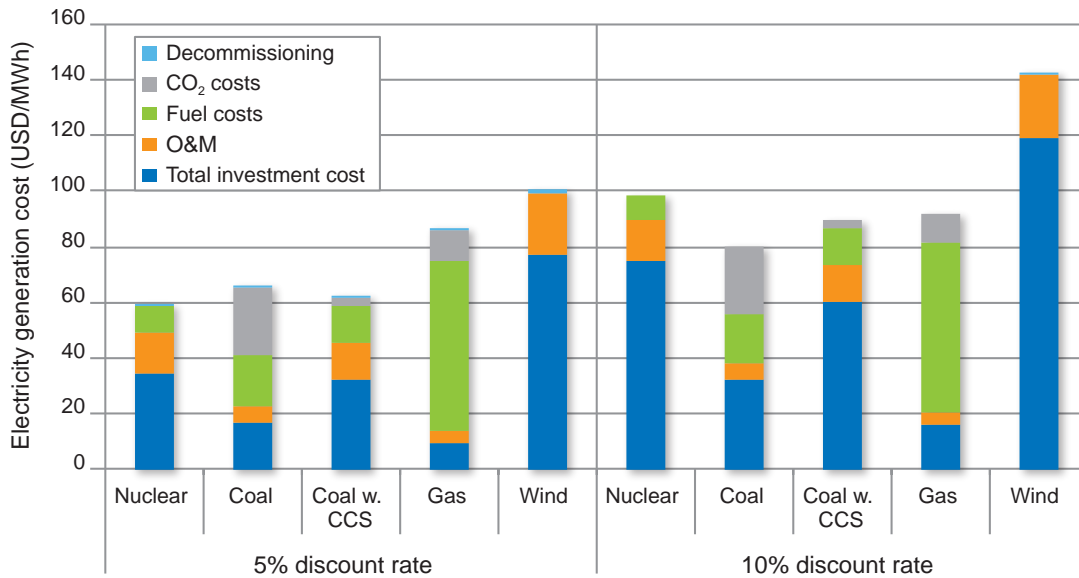

Source: IEA/NEA, 2010.

**Figure 3.17: LCOE variation as a function of the load factor (at 5% discount rate)**

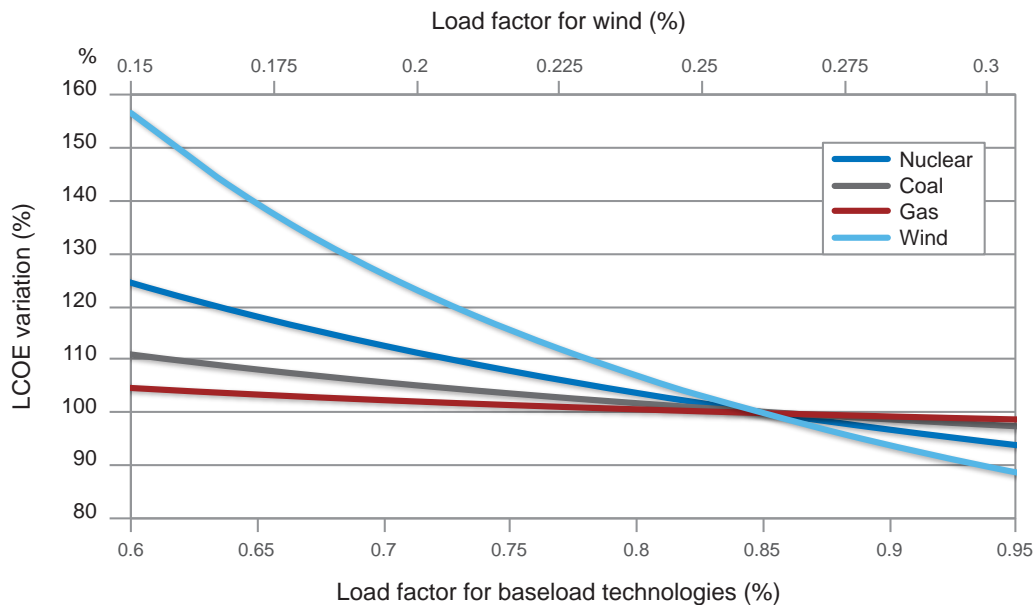

Note: The average load factor used in the IEA/NEA report is 26% for wind.

Source: IEA/NEA, 2010.



An increase in the availability and load factor of nuclear power plants would have important benefits for both the nuclear industry and the global electricity market. On one hand this would reduce the production cost of nuclear proportionally more than that of other generating sources, thus making nuclear energy more competitive. On the other hand, this would bring additional “free” capacity and electricity into the market, with a beneficial effect on customer prices and supply security. It can be estimated that an increase in the load factor of nuclear power plants from present values to 94% (which is achieved by the best 10% of nuclear power plants), would increase electrical capacity by 63 GW and yearly electricity production by 440 TWh, relative to 2010 data. This represents the equivalent of 40 new large nuclear reactors.

From an economic viewpoint, the load factor has a significant impact on the economics of power generation, in particular for capital-intensive technologies such as nuclear, coal with CCS and most of the renewables. Increasing the load factor and the electricity output offers the possibility to recover more rapidly the capital and the fixed operational costs.

Higher availability and load factors from conventional power plants do not only have important economical significance for the plant owner, but also provide positive externalities for the whole electrical system. A conventional power plant with a higher capacity factor has the ability to provide back-up capacity for variable renewables as well as ancillary services to the electricity grid.

### **Management of nuclear fleets to reduce system costs**

This analysis will show the significant economic benefits from optimising nuclear fleet management with respect to seasonal variations of electricity demand. Primarily, fleet management reduces the maximal residual demand imbalance of the power system and thus the need for building additional generation capacity. In addition, fleet management reduces the average energy production cost by improving the use of different electricity production capacities.

The management of a nuclear power plant campaign attempts to optimise some major operational parameters, such as cycle length, operational plant flexibility, vessel irradiation and overall fuel cost, given specific safety-related, technical and economical constraints. Those constraints set a limit on fuel enrichment, average and maximal burn-up, power peaking factor and boron concentration during operation. Safety concerns require negative fuel and coolant coefficients and a minimal anti-reactivity margin throughout reactor operation.

The major elements of fuel management optimisation are the fuel enrichment and average burn-up, the cycle length and the core reload fraction.<sup>16</sup> In modern power plants, only a fraction of the assemblies is discharged and replaced at each reload. For example, in a 3-batch strategy only 1/3 of the assemblies are replaced at each refuelling; thus each fuel assembly stays in the core for 3 cycles.

All other things being equal, increasing the initial fuel enrichment allows for higher average burn-up and a longer fuel cycle; the fuel utilisation and the power plant load factor are thus improved. On the other hand, a higher enrichment results in a burden on the fuel fabrication plant, higher fabrication cost and additional technical-economic constraints for fuel transport and storage. Nowadays the uranium oxide fuel enrichment is limited to 5% in a standard LWR.

Fractioning the core allows for a lower enrichment and/or a higher burn-up, which results in better fuel utilisation. Needs for fuel fabrication, transport, reprocessing and long-term storage are thus reduced, as well as their associated costs. The neutronic characteristics of the core are also improved by a reduced reactivity swing during the campaign and a flatter flux and power distribution across the core. The excess of reactivity to be compensated at the beginning of the cycle is thus reduced, which results in a lower initial boron concentration. On the other hand, more frequent fuel reload reduces the cycle length, since the power plant has to be shut down more often. A shorter cycle length represents an important economical penalty since it degrades the plant’s availability and load factor. Also, more frequent reload increases operational cost, as well as the radiation dose to plant workers.

16. The fuel length is defined as the number of days operated at full power and therefore is related only to the thermal energy produced from the plant. The actual calendar duration of a campaign depends also on the global load factor.

Another essential parameter for nuclear power plant management and fuel cycle optimisation is the load variability, i.e. the possibility to go beyond (or to reduce) the natural cycle length in response to economical requirements. The more recent operating strategies allow for replacing few assemblies more (or less) than those required in a standard recharge. However, safety and operational concerns set a limit to the load variability: in France the load variability is limited to  $\pm 4$  up to  $\pm 8$  assemblies, depending on the reactor type and the fuel management option. This variability allows for an increase of the natural cycle length if more new assemblies are charged in the reactor or for its reduction, if fewer assemblies than normal are substituted. In France, variability can prolong or reduce the overall cycle length by as much as 60 days.<sup>17</sup>

Presently, the majority of light water reactors (LWRs) operate with a 3 fuel batch and the length of a campaign ranges from 12 to 18 months; however, some power plants achieve a 24-month cycle length. The fuel enrichment varies generally from 3% and 5%, while average burn-up ranges from 33 to 50  $\text{GW}_d/\text{t}_{\text{HM}}$  ( $\text{GW}_d$  days per tonne of heavy metal).

### *Nuclear fleet management – basic considerations*

With the liberalisation of energy markets, the economical optimisation of the nuclear fleet depends more and more on the capacity of adjusting to seasonal and daily changes in the production/demand curve and of quickly responding to grid needs. The flexibility is already a fundamental requirement for the nuclear industry, and will become increasingly important in the future.

The rationale for the management of any baseload technology is that the energy supply should follow as closely as possible the residual demand, defined as the difference between electricity demand and the supply from other technologies with lower marginal cost. In the case of nuclear, the residual demand can be calculated as the total electricity demand minus the hydro-electrical production<sup>18</sup> and the average seasonal production from renewables. All nuclear operators try to schedule planned outages in the period with lower residual demand, in order to have maximal power plant availability during the peak season.

France is a very good example of fleet management, given the presence of a single operator (EDF operates 58 units) and a large and well-integrated electricity market. The high share of nuclear in the French energy mix poses strong requirements for a seasonal adjustment of nuclear energy production but the size of the fleet also allows for a large amount of internal co-ordination. A large nuclear fleet gives more flexibility but imposes also additional constraints on the operator. For instance, it is necessary to allow for a minimal interval between refuelling outages at different units on the same site. Also, there is a limit on manpower that can be deployed during outages, which limits the number of outages that can be planned at the same time.

Presently EDF operates its nuclear fleet in the following way:

- 6 units of 900 MW (CP0) with a 3-batch strategy and a 15-month refuelling interval;
- 28 units of 900 MW (CPY) with a 4-batch strategy and a yearly refuelling interval;
- 20 units of 1 300 MW (1300) with a 3-batch strategy and an 18-month refuelling interval;
- 2 units of 1 450 MW (N4) with a 3-batch strategy and a yearly refuelling interval;
- 2 units of 1 450 MW (N4) with a 3-batch strategy and an 18 month refuelling interval.

Outages are scheduled in spring and in autumn for the units that follow an 18-month cycle, while the units that operate in a 12-month cycle tend to distribute their outages between spring and autumn.

17. Boiling water reactors (BWRs) offer additional flexibility in plant management, allowing for extended operation beyond the natural cycle length. Increasing the speed of internal re-circulation pumps reduces the average coolant temperature and the core void fraction, thus bringing in extra reactivity; this extra reactivity allows for operating the reactor at full power for a certain time beyond the natural cycle length. Reducing progressively the reactor power (up to 85% of the nominal power) and the temperature of feed-water allows for some extra reactivity, thus extending operations further. Pressurised water reactors (PWRs) also offer the possibility of increasing operation beyond the natural cycle length by taking advantage of the power and coolant temperature reactivity coefficients. A decrease of reactor power and coolant temperature allows for a 30-60 equivalent full power days (efpd) extension beyond natural fuel cycle length.

18. Only non-storable hydro-electrical capacity should be considered here.

### *Evolution of the French fuel management strategy*

The flexibility of the nuclear industry in adapting the fuel management strategy in response to external economic market conditions has been clearly demonstrated in France during the 1990s. In the mid-1980s economic forecasts were calling for a moderate increase in energy demand for the coming years and for a substantial overcapacity of the French nuclear park. The nuclear energy was supposed to be the marginal for about 7 000 hours, i.e. for more than 80% of the year. Given these assumptions, starting from 1988 EDF decided to implement a 4-batch strategy with a cycle length reduced to 275 equivalent full power days (efpd) with respect to the former 3-batch and 330 efpd strategy. This change allowed for a 12% reduction in the overall fuel cycle cost and for a better fuel utilisation. However, a few years later, the forecast turned out to be inaccurate, with energy demand rising unexpectedly and the nuclear park being at margins only for 2 000 hours per year. The demand increase, in conjunction with an extension of the refuelling outages, justified a change in the fuel management strategy, with the adoption of a 3-batch strategy, at least for part of the nuclear fleet, and a progressive lengthening of the cycle.

The future trend for fleet management calls for longer campaigns with both a burn-up and initial enrichment increase. In particular, the 28 CPY units and the 2 N4 reactors should achieve a 15-month and an 18-month cycle length, respectively.

### *The economic value of fleet management in France*

This section shows how EDF manages its nuclear park in response to seasonal fluctuations of electricity demand. This analysis is made initially considering only internal demand and, in a second step, also taking into account electricity exchanges with neighbouring countries. Finally the economical benefit of seasonal load following for the operator is estimated.

Figure 3.18 shows the weekly medium- long-term forecast of electricity demand and nuclear supply in France; these data are provided by RTE, the French electric grid operator, and cover the interval between August 2009 and December 2011. The demand curve (in red on the figure) is the weekly average demand in France from Monday to Friday between 8:00 and 20:00. The corresponding residual demand is plotted in pink, while the planned outages of nuclear plants and residual nuclear capacity are plotted in blue, as dotted and solid lines (respectively).

The operator's ability to plan the outages during the year in order to follow the seasonal demand curve is clearly visible on the figure: nuclear fleet availability is maximal during winter along with residual demand.

In order to estimate the benefits of seasonal load following, the residual electricity demand, deducting the hydro-electrical and nuclear contribution from the 2009-2011 demand forecast by RTE, was calculated. This "real" data take into account the seasonal load following of the nuclear fleet. This "real" curve was compared with the one that would result if nuclear outages could not be planned and were uniformly distributed over the whole year; these data are labelled as "outages averaged" in Figure 3.19.<sup>19</sup>

Seasonal nuclear fleet management contributes significantly to stabilise residual electricity demand in France. The volatility of residual demand, as well as the maximal power imbalances (both negative and positive) seen by the electrical grid, has been significantly reduced. Both of these aspects have important beneficial consequences for the whole electrical system.

The maximum of residual demand sets the maximal power that the electricity system has to provide with other more expensive energy sources or, eventually, with electricity imports. By lowering this maximal imbalance, one reduces the additional residual capacity needed in the system to balance demand. In France, seasonal fleet management reduces the maximal residual demand by 6.4 GW, from 17.6 to 11.2 GW. Based on EURELECTRIC/VGB data (IEA/NEA, 2010), in France the overnight investment cost of an additional capacity of 6 GW can be estimated at USD 11.7 billion if coal plants are built coal, and at USD 7.2 billion for gas-fuelled units. If normalised to the electricity produced by the nuclear park, the yearly benefits of seasonal management of nuclear plants can thus be estimated to be EUR 0.62/MWh for gas and at EUR 0.95/MWh for coal.

19. These figures take into account also the forecast import/export electricity balance with neighbouring countries, calculated as the average of the previous three years.

**Figure 3.18: Seasonal evolution of electricity demand and nuclear supply in France**

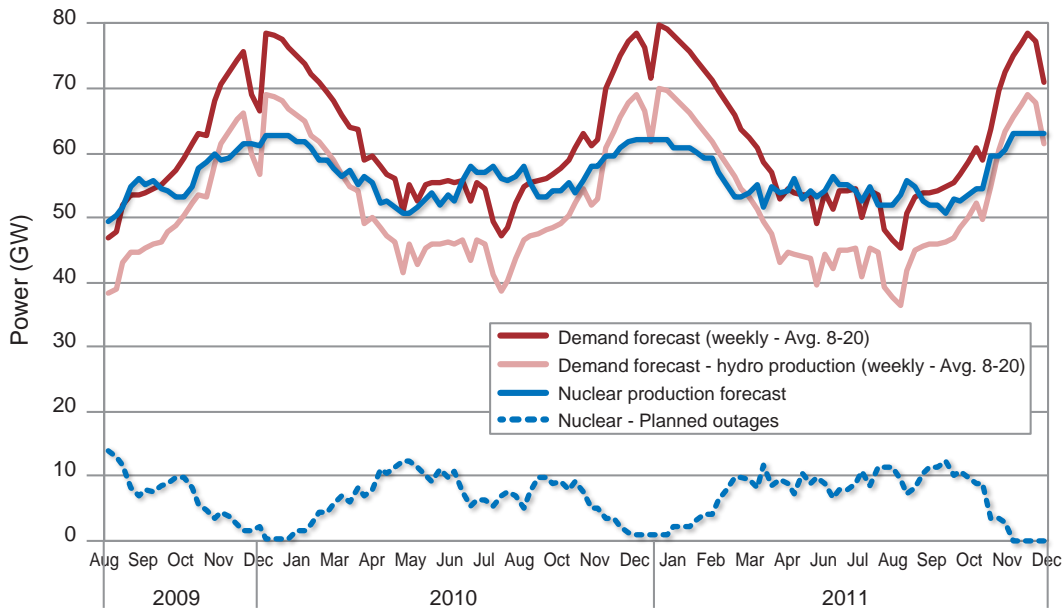

Note: Demand prevision and nuclear planned outages in France from mid-2009 to 2011.

Source: Based on RTE data.

**Figure 3.19: Effect of seasonal management on the residual demand (including import/export)**

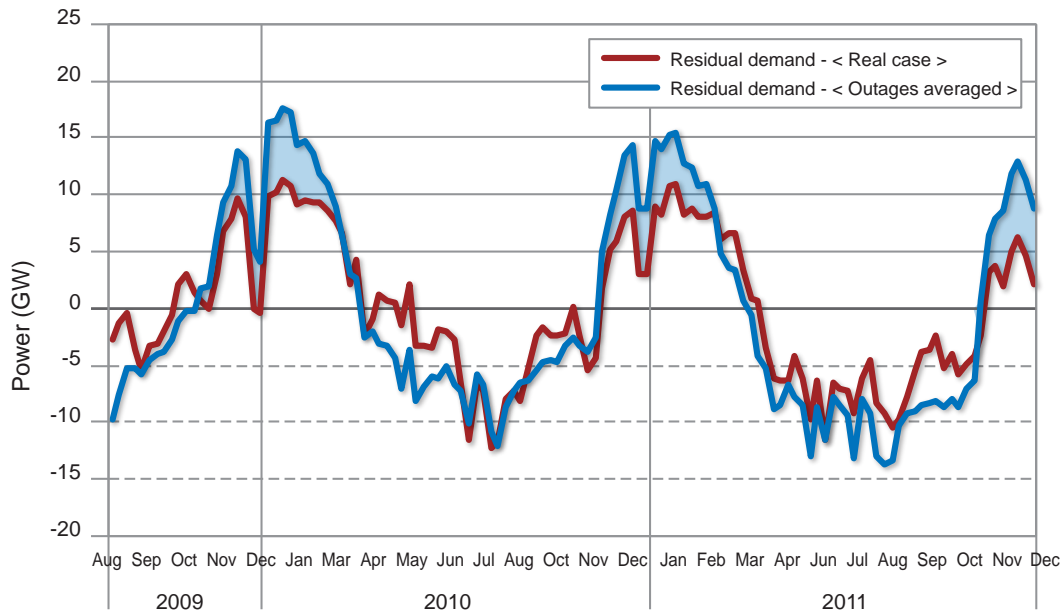

Note: Residual demand in France including export/import balance – “real” case vs. “unplanned”.

Source: Based on RTE data.

The second benefit arising from seasonal fleet management is the reduction of the overall quantity of electricity that has to be provided by more expensive non-nuclear technologies. In France, seasonal load following reduces the residual electricity need for the two years 2010 and 2011 to 16.8 TWh from the 25.1 TWh that would be needed if no seasonal load following were adopted. The economical benefit resulting from the reduction of variable cost can be estimated at EUR 72 million if nuclear production were replaced by coal, and EUR 245 million if replaced by gas.<sup>20</sup> This corresponds to a yearly benefit of EUR 0.07 and EUR 0.25/MWh, respectively. However, this last consideration applies only to a situation in which nuclear energy is often at margins and is therefore peculiar to countries with a large share of nuclear power.

If both averted investments in new capacity and reduction of variable cost are considered, the economical benefit of nuclear fleet can be estimated at EUR 0.9-1.0/MWh of electricity produced by nuclear power plants in France.

An alternative and complementary way to assess the economical benefit of nuclear fleet management in France is to compare the value of the electricity that has been generated in the “real” case with the value of what would have been produced if outages were uniformly distributed over the whole year. Table 3.6 summarises the results for the 2007-2009 period. The first column shows, for each month, the difference between the forecasted nuclear capacity (“the real case”) with the one resulting if no fleet management was possible. By construction, the sum over each year is equal to zero. The second column gives the monthly forward price of electricity on the EEX market, averaged over the volumes. Finally, the third column is simply the product over the 2 first columns; for consistency each month is assumed to have the same number of hours. Under those assumptions, the economic value of nuclear fleet management in France can be quantified as EUR 235 million in 2007, EUR 150 million in 2008 and EUR 256 million in 2009.

If related to the whole energy produced with nuclear reactors during those three years, the economical value of fleet management in France corresponds to about EUR 0.44/MWh, or, in other terms to about 1% of the levelised cost of nuclear electricity production (based on IEA/NEA, 2010).

**Table 3.6: Estimation of seasonal management value**

	2007			2008			2009		
	Excess capacity GW	Forward price EUR/MWh	Value M EUR	Excess capacity GW	Forward price EUR/MWh	Value M EUR	Excess capacity GW	Forward price EUR/MWh	Value M EUR
January	4.24	63.7	197.3	5.76	68.6	288.5	5.45	65.1	259.1
February	1.87	53.8	73.4	3.17	66.7	154.3	5.40	60.6	238.7
March	-2.31	43.0	-72.5	-0.95	57.8	-40.3	0.43	48.2	15.2
April	-4.08	30.3	-90.1	-4.10	58.5	-175.1	-4.33	38.2	-120.8
May	-3.83	29.4	-82.3	-4.48	55.6	-182.0	-3.67	34.3	-91.8
June	-1.92	39.4	-55.1	-3.49	63.3	-161.2	-1.95	36.9	-52.6
July	-1.00	45.8	-33.5	-1.37	73.3	-73.2	-2.82	37.6	-77.3
August	-0.64	38.1	-17.7	-0.59	70.9	-30.4	-3.86	33.2	-93.7
September	-0.87	37.1	-23.7	-2.95	77.5	-167.2	-1.39	38.3	-38.8
October	0.66	38.9	18.8	-1.74	82.1	-104.5	-1.56	42.6	-48.6
November	2.36	52.7	90.8	4.67	89.5	304.9	3.09	47.8	107.8
December	5.52	57.0	229.6	6.07	75.8	336.0	5.21	41.8	158.8
<b>Total for the year</b>	0.00		<b>234.9</b>	0.00		<b>149.9</b>	0.00		<b>256.0</b>

20. Based on EURELECTRIC/VG fuel and O&M cost data in IEA/NEA (2010). No carbon cost is considered here.

### 3.3 Conclusion

Nuclear energy thus contributes both to short-run balancing and long-run adequacy through load following and appropriate fleet management for regular refuelling. Based on the experience in France and Germany, this study finds that in terms of short-run load following, the technical capabilities of nuclear energy are comparable to those of large coal-fired units, are only slightly below those of combined cycle gas plants, but remain inferior to those of open cycle gas or oil turbines. Such short-run load following may constitute not only an essential contribution at the system-level but also an economically useful tool at the level of the plant and the electricity market. As prices in the day-ahead market become increasingly volatile, drop more frequently below the variable costs of nuclear power production and occasionally turn negative, the ability to stop production at constant levels becomes a vital part of an operator's financial viability.

In the long run, intelligent management of a reactor fleet's regular outages minimises the system costs of nuclear, which otherwise would require larger amounts of back-up, and contributes considerably to an electricity system's capacity and power production. While other dispatchable technologies such as coal- and gas-fired power plants can provide similar services at the system level, none of them is able to do so without emitting substantial amounts of carbon. The resources of the only remaining alternative, hydroelectric power, are in most OECD countries mainly exhausted. In other words, it is hard to imagine future low-carbon electricity systems with substantive amounts of variable renewables without the contribution of nuclear power to balancing and adequacy.

## References

- Aminov, R.Z. et al. (1990), *АЭС с ВВЭР: Режимы, Характеристики, Эффективность* (NPP with VVER: Regimes, Characteristics, Efficiency, in Russian), Energoatomizdat, Moscow, Russian Federation.
- AREVA (2010), “Load Follow: Nuclear Power Compatibility with the Deployment of Intermittent Renewables”, AREVA Position Paper, 15 December 2010. Available at [www.areva.com/fieldreport](http://www.areva.com/fieldreport).
- Brochard, J. et al. (2001), *Modelling of Pellet Cladding Interaction in PWR Fuel*, SMiRT 16, Washington, D.C., United States. Available at [www.iasmirt.org/smirt/16](http://www.iasmirt.org/smirt/16).
- Coppolani, P. et al. (2004), *La chaudière des réacteurs à eau sous pression*, EDP Sciences, Les Ulis, France.
- DOE (2008), *20% Wind Energy by 2030. Increasing Wind Energy’s Contribution to U.S. Electricity Supply*; US Department of Energy, Energy efficiency and Renewable Energy, June 2008. Available at [www.osti.gov/bridge](http://www.osti.gov/bridge).
- EC JRC (2010), *Load-following Operating Mode at Nuclear Power Plants (NPPs) and Incidence on Operation and Maintenance (O&M) Costs. Compatibility with Wind Power Variability*, C. Bruynooghe, A. Eriksson, G. Fulli, European Commission, JRC Scientific and Technical Reports, Brussels, Belgium.
- EUR (2001), *The European Utility Requirement (EUR) document*, Volume 2, Revision C, April 2001.
- GE (2006), *ABWR Plant General Description – December 2006*, General Electric Company, Nuclear Energy. Available at [www.fornuclear.org/images/stories/recursos/zona-descarga/Descripcion\\_general\\_ABWR\\_GE.pdf](http://www.fornuclear.org/images/stories/recursos/zona-descarga/Descripcion_general_ABWR_GE.pdf).
- IAEA (2002), *Nuclear Power Plant Outage Optimisation Strategy*, IAEA TECDOC 1315, Vienna, Austria.
- IAEA (2003a), *Guidance for Optimizing Nuclear Power Plant Maintenance Programmes*, IAEA TECDOC 1383, Vienna, Austria.
- IAEA (2003b), *Periodic Safety Review of Nuclear Power Plants*, IAEA Safety Standards Series No. NS-G-2.10, Vienna, Austria.
- IAEA (2006), *Indicators for Management of Planned Outages in Nuclear Power Plants*, IAEA TECDOC 1490, Vienna, Austria.
- IAEA (2010a), *Periodic Safety Review of Nuclear Power Plants: Experience of Member States*, IAEA TECDOC 1643, Vienna, Austria.
- IAEA (2010b), *Review of Fuel Failures in Water Cooled Reactors*, Nuclear Energy Series, NF-T-2.1, Vienna, Austria.
- IEA (2011a), *Harnessing Variable Renewables: A Guide to the Balancing Challenge*, International Energy Agency, OECD, Paris, France.
- IEA (2011b), *Electricity Security*, International Energy Agency, OECD, Paris, France.
- IEA/NEA (2010), *Projected Costs of Generating Electricity – 2010 Edition*, International Energy Agency and Nuclear Energy Agency, OECD, Paris, France.
- Kerkar, N. and P. Paulin (2008), *Exploitation des cœurs REP*, Éditeur EDP Sciences, Institut national des sciences et techniques nucléaires, collection Génie Atomique, Les Ulis, France.
- Knott, D. and C. Oyarzun, *MARLA: Software for Planning Fuel Shuffles and Dry Cask Storage Campaigns*. Studsvik reference publication. Available at [www.studsvikscandpower.com/products/marla/resources](http://www.studsvikscandpower.com/products/marla/resources).
- Ludwig, H. et al. (2010), “Load Cycling Capabilities of German Nuclear Power Plants”, Vol. 55, No. 8, August/September 2010, *International Journal for Nuclear Power*. Available at: [http://en.kernenergie.de/kernenergie/documentpool/Aug-Sept/atw2010\\_09\\_waas\\_lastwechselfaehigkeiten\\_kkw\\_en.pdf](http://en.kernenergie.de/kernenergie/documentpool/Aug-Sept/atw2010_09_waas_lastwechselfaehigkeiten_kkw_en.pdf).
- Mokhov, V.A and M.A. Podshibiakin (2010), “Обоснование проектов реакторных установок ВВЭР 1000/1200 при работе АЭС в маневренных режимах” (Study of the NPP with VVER-1000/1200 reactors operation in manoeuvrable mode), Proceedings of the Energia-2010 Conference (in Russian), pp. 103-106, 1-3 June 2010, Moscow, Russian Federation. Available at: [www.energy2010.mpei.ru/\\_Files/Proceedings1.pdf](http://www.energy2010.mpei.ru/_Files/Proceedings1.pdf).

NEA (2011a), *Technical and Economic Aspects of Load Following with Nuclear Power Plants*, Nuclear Energy Agency, OECD, Paris, France. Available at [www.oecd-nea.org/ndd/reports/2011/load-following-npp.pdf](http://www.oecd-nea.org/ndd/reports/2011/load-following-npp.pdf).

NEA (2011b), *Carbon Pricing, Power Markets and the Competitiveness of Nuclear Power*, Nuclear Energy Agency, OECD, Paris, France. Available at [www.oecdbookshop.org/oecd/display.asp?lang=EN&sf1=identifiers&st1=978-92-64-11887-4](http://www.oecdbookshop.org/oecd/display.asp?lang=EN&sf1=identifiers&st1=978-92-64-11887-4).

Pouret, L. and W. Nuttall (2007), *Can Nuclear Power Be Flexible?*, Electricity Policy Research Group, Working Papers, No. 07/10, University of Cambridge, Cambridge, United Kingdom.

Provost, L. and M. Debes (2006), “EDF PWR Fuels Operating Experience and High Burn Performances”, Proceedings of TopFuel-2006, Salamanca.

WNA (2012), *Optimized Capacity: Global Trend and Issues*, A Report by World Nuclear Association, Capacity Optimization Working Group, London, United Kingdom. Available at [www.world-nuclear.org/uploadedFiles/REPORT\\_OptimizCapacity.pdf](http://www.world-nuclear.org/uploadedFiles/REPORT_OptimizCapacity.pdf).



## Chapter 4

# Determining and measuring the system costs of power generation

The preceding chapters presented the grid effects of nuclear power as well as the latter's ability to respond to the intermittency of renewables such as wind and solar in the decarbonising electricity systems. The present chapter broadens and deepens the treatment of system effects. Section 4.1 provides an overview of system effects or externalities in the power sector with the help of the comprehensive system cost matrix. It will also characterise more specifically the system effects at the grid-level, such as additional investments in the grid transport infrastructure, short-term balancing and long-term back-up capacity. It thus prepares the quantitative estimation of these grid effects in Section 4.2 with the help of a specific model developed for the estimation of system costs. Section 4.3 will determine the long-term optimal configuration of dispatchable back-up capacity for large amounts of variable renewables as a consequence of reduced load factors ("compression effect") and assess in particular the implications for the future construction of new nuclear plants. The results in Sections 4.2 and 4.3 are based on two models developed by the OECD Nuclear Energy Agency that were designed to help decision-makers to develop a perspective of power generation choices that goes beyond plant-level costs as well as to develop appropriate response strategies for the system effects of variable renewables.

### 4.1 System costs in the electricity sector: the system cost matrix

In Chapter 1 system costs were defined as *the total costs above plant-level costs to supply electricity at a given load and given level of security of supply*. At that moment it was emphasised that the system costs this study was concerned with were primarily grid-level costs, i.e. the subset of system costs mediated by the physical grid. Here, we take a step back to provide a broader overview of the total system effects of power generation. This includes externalities that are difficult to quantify, such as the contribution of a given technology to the security of energy supply or its impacts on the environment. The different dimensions of system costs are presented together in the form of a matrix of system costs. Negative and positive impacts are indicated with a simple qualitative scoring system, designed to stimulate discussions rather than to provide definite answers. The system cost matrix constitutes a qualitative summary of discussions about different parameters of system costs based on previous work of the OECD Nuclear Energy Agency such as NEA (2010) and NEA (2011) as well as relevant publications by other institutions.

The relationship between plant-level costs, grid-level costs and overall system costs is synthesised in Figure 4.1. Progressing from plant-level costs to total system costs means including a progressively larger array of cost items at ever higher levels of interaction of a given technology first with the electrical transmission system and then with the wider natural, economic, social and political environment. As outlined in Chapter 1, total system costs are equivalent to the sum of the external effects of power generation. However, this implies progressing from well-codified and widely accepted systems for cost accounting to more tentative cost estimates heavily driven by ad hoc assumptions. The broken line around the zone labelled "total system costs" indicates that it becomes increasingly more difficult to define with precision the perimeter of the cost elements entering the respective calculations.

This does not imply that preparing and providing such estimates is without value, quite to the contrary. Explorative attempts at quantification are frequently the first step in generating the societal discussion processes that lead with time to more widely accepted systems for cost accounting (one need but think of accounting for CO<sub>2</sub> emissions) and subsequently to better forms of internalisation.

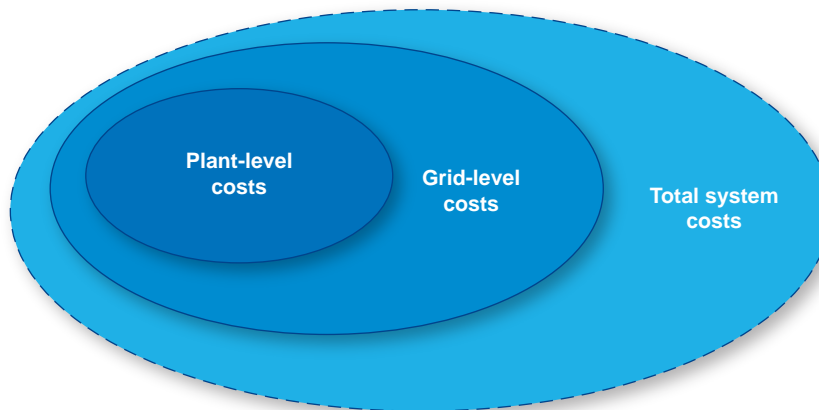
**Figure 4.1: Plant-level, grid-level and total system costs**

In the discussion of the different elements of the system cost matrix below, one needs to be mindful of these *caveats*. A good conceptual understanding is the essential condition for any attempt at quantification. This is why the following discussion of the different items of the system cost matrix distinguishes clearly between “grid-level system costs”, which are the subset of system costs which can be usefully quantified in the context of this study, and “total system costs” which include external effects, where quantification and monetisation in the present context would not add any value.

In order to understand the last point, one but needs to look at the *ExternE – Externalities of Energy* assessment of environmental externalities by the European Commission, whose ten volumes were published between 1995 and 1999, the eight-volume study by Oak Ridge National Laboratory in the United States, as well as the more recent NEEDS-project.<sup>1</sup> All three involved ultimately hundreds of researchers at various levels but covered only two of the ten categories of system costs listed in the system cost matrix “greenhouse gas emissions” and “local and regional environmental impacts”. Many of their results are also highly dependent on modelling assumptions concerning the dispersion modelling of airborne pollutants that depend on local circumstances.

The extraordinary effort necessary to monetise externalities is no coincidence. By definition, externalities are difficult to quantify, which is precisely the reason why they are “external” to traditional cost accounting conventions, which for good reason apply to the perimeter of the enterprise. This should not discourage researchers or decision-makers in pursuing both the quantitative assessment of system costs and their internalisation through appropriate policy measures. Two points in this context are worth remembering. First, the fact that external effects or system costs are difficult to quantify in an explicit manner does not mean that they do not exist. Second, the fact that externalities are not quantified does not imply that they cannot be internalised in an implicit manner.<sup>2</sup> Appropriately defined legal liabilities, joint ownership or even just better information and transparency can be powerful tools to force the generators of system effects to take them into account without ever passing through explicit monetisation of system effects. For instance, imputing additional costs for network extension or reinforcement to the generators who cause them would clearly go some way towards minimising the joint costs of generation and transportation rather than have generators choose sites with no regards for transportation costs.

1. EC (1995), ORNL (1992-1998) and the web-based NEEDS-project ([www.needs-project.org](http://www.needs-project.org)).

2. An externality-sceptic might legitimately ask whether internalisation can proceed at transaction costs that are lower than the negative welfare impacts of the externality itself. The denial of this proposition implied the famous “externalities-should-be-left-alone” position of Ronald Coase and his fellow economists from the University of Chicago. However, the Chicago School argument hinges on the assumption that technologies, institutions, knowledge and preferences remain static forever. This is clearly untenable since one of the principal characteristics of externalities is their “newness” and hence the technological and institutional change they provoke in response to better information and clearer understanding of impacts and preferences (see Keppler, 2010).

The focus of the present chapter, however, is the issue of grid-level costs which is introduced in this section and for which quantitative estimates are provided in Section 4.2. While this section discusses all the different elements of the system cost matrix (Table 4.1), only grid-level costs, in particular, the grid-level costs of variable renewables, are now, after considerable amounts of preliminary research, beginning to be sufficiently well understood to allow the provision of estimates based on empirical data.

**Table 4.1: The system cost matrix**

**Part A. Grid costs with quantitative estimates in Section 4.2**

	Grid connection	Grid reinforcement	Grid dependency	Intermittency technical	Intermittency financial
Nuclear	↘	↘	↘↘↘	↗	↗
Coal	↔	↘	↘	↗	↗
Coal w/CCS	↔	↘	↘	↗	↗
Gas	↗	↗	↘	↗	↗
Hydro	↔↘	↘	↗	↗	↗
Wind onshore	↘	↘↘	↗	↘↘↘	↘↘↘
Wind offshore	↘↘↘	↘↘	↗	↘↘↘	↘↘↘
Biomass	↗	↗	↗	↗	↗
PV and CSP	↘↘	↘	↗	↘↘	↘↘

**Part B. System costs other than grid costs without quantitative estimation**

	Grid connection	Grid reinforcement	Grid dependency	Intermittency technical	Intermittency financial
Nuclear	↗	↗	↘	↘	↘
Coal	↘	↘↘↘	↘↘	↘	↘
Coal w/CCS	↘	↘	↘↘	↘↘	↘
Gas	↘↘	↘↘	↘	↗	↘
Hydro	↗	↘	↘↘	↘↘	↘↘
Wind onshore	↗	↔	↘	↘↘	↗
Wind offshore	↗	↗	↘	↘↘	↗
Biomass	↗	↗	↘	↘↘	↗
PV and CSP	↗	↗	↘	↘↘	↗

The number of arrows qualitatively indicates the relative importance of the issue. Green arrows pointing upwards indicate a positive impact, red arrows pointing downwards a negative impact and a blue horizontal arrow a neutral impact. In the following, the different categories of system costs mentioned above and what they mean for different technologies are briefly discussed.

### Grid connection

The costs for grid connection, grid extension and grid reinforcement are all part of transmission costs or the costs of investing in new electrical transport infrastructure. Grid connection refers to the physical connection of a power plant to the nearest connecting point of the existing high-voltage power grid. Grid connection costs thus refer to the investments in transport infrastructure necessary to accommodate the grid connection of new power plants, in particular those outside the area served by the existing grid such as offshore wind-power turbines. The principal drivers of connection costs are the distance between power plant and existing grid, the territory that is crossed, the transmission capacity required and, eventually, the special needs of the plant that must be connected.

As expected, the overall cost of transmission increases with distance. The costs, however, are not directly proportional to the length of the transmission line due to economies of scale and to the existence of certain fixed costs independent of distance. The size of a power plant and its load factor are also decisive factors for the connection costs. Other things being equal, larger loads allow for using higher voltage lines, which are more efficient and proportionally cheaper. Also, since the costs for a transmission line are independent of the load factor of the plant, the connection cost per MWh decreases with higher load factors. In this respect, large dispatchable power plants based on nuclear, coal or gas benefit from larger output and higher load factors. In addition, coal and gas plants can be sited more easily than renewables, which must be located according to the geographical availability of their natural resources, in particular wind and sun. In terms of locational requirements, nuclear power plants have an intermediate position defined, in particular, by the fact that proximity to a natural cooling site is highly desirable, if not absolutely necessary as air cooling remains as a possibility in certain environments.

Connection costs are particularly relevant for offshore wind farms which must be located in appropriately windy conditions of up to 50 km off the coast, requiring expensive marine cable connections. The Dena Study II provides some valuable indications of the investments needed. Connecting the planned 7 000 MW of new offshore capacity to the German electricity grid would require 1 500 km of new transmission lines with 1 100 MW of capacity at a cost of EUR 3.7 billion.<sup>3</sup> Transmission losses and reactive power needs would add further costs in the order of 18% of the initial investment costs. To illustrate the magnitude of the surplus costs this generates (see Table 4.2), the grid investments were normalised to a scale compatible with the NEA's model for the accounting of LCOE that was the basis for the IEA/NEA publication *Projected Costs of Generating Electricity: 2010 Edition*. For a 100 MW offshore wind-plant close to the shore a distance of 20 km was assumed, which implies additional investment costs of roughly EUR 50 million. For an equivalent plant far from the shore at 50 km, investment costs would be EUR 125 million.<sup>4</sup> Integrating this data into the NEA model calibrated on data for two wind-farms, one close, one far, provided by EURELECTRIC/VGB (see IEA/NEA, 2010, p. 62) yields the following results.

**Table 4.2: The cost increase for a 100 MW offshore wind farm due to the integration of grid connection costs**

	Discount rate (%)	Plant cost only (EUR/MWh)	Connection cost (EUR/MWh)	Total cost (EUR/MWh)	Cost increase for connection
Offshore close (20 km)	5%	82.6	26.1	108.7	31%
	10%	111.2	32.6	143.8	29%
Offshore far (50 km)	5%	93.6	55.0	148.6	59%
	10%	124.3	68.7	193.0	55%

Source: Based on Dena Study II and IEA/NEA, 2010.

Allocating the costs of investments in grid connection for offshore wind power to the operators would increase the latter's unit costs between 29% and 59% depending on the distance from the shore and the interest rate. Section 4.2 will provide systematic estimates of grid connection costs for offshore wind in six different OECD countries.

### Grid extension and reinforcement

Grid extension and reinforcement refers to investments in the transport infrastructure such as the upgrade of existing power lines as well as the construction of additional lines within the existing grid. Upgrades and extensions of the existing power grid might be motivated by different reasons such as a structural surplus of production in some regions, an increase in the power trade across different regions and the modification of the demand/production structure within a given area. A well-known example is

3. Dena (2010). The Dena Study II assumes the overall capacity of new offshore investment to be 14 000 MW by 2020. However, cost figures are provided for a first tranche of 7 000 MW.

4. Assuming a 20-year lifetime, this implies additional annual variable costs of EUR 450 000 for the 20-km line and EUR 1.125 million for the 50-km line.

constituted by Germany, where wind production mainly takes place in the northern part of the country but electricity is required in the industrial west and south of the country, regions that are also disproportionately affected by the recent shutdown of eight of the country’s nuclear reactors (see Box 4.1). This north-south transfer is already testing the capacity of existing grids to the limit and any expansion of wind capacity will require additional investments in internal transmission.

The reinforcement of the existing grid or the construction of new transmission lines from the grid operator may have different motivations and respond to multiple needs: connecting new power plants located far from the load centres that they serve, improving the interconnections within the electricity system, allowing for better congestion management, and improving reliability of the overall electrical grid. In general, grid reinforcement and extensions benefits all the players of the electricity market, although at different levels. When adding significant amounts of new capacity, it is therefore difficult to allocate those costs among different market participants. In most studies, however, the reinforcement costs have been determined as the additional investments in the transmission grid after the integration of a given amount of renewable energy, in comparison with those required for an “equivalent” system without renewables.

It should also be mentioned that distribution grids may require upgrading for large amounts of decentralised power generation such as rooftop solar panels. However, reinforcement costs at the distribution level were not considered in this analysis, due to the lack of systematic data on this issue.

#### Box 4.1

##### The challenge of linking variable renewables to the grid in Germany

The North Sea offers important wind resources. With the ambitious 2020 renewable targets set by the European Commission and the recent decision taken by the German government to phase out nuclear energy, the North Sea becomes a key source for Germany’s energy supply and energy security. A big challenge for Germany will be to properly connect the renewable production from the northern part of the country with the big industrial demand centres located at the southern part of the country. A study published in 2010 (Weigt *et al.*, 2010), shows that the solution maximising social welfare would be to build HVDC lines to connect the north part of the country with the south. HVDC transmission lines would substantially improve internal interconnection through congestion alleviation and enlarge the current balancing areas. This would help to achieve more variable renewable integration at peak production moments. This study showed that this was a better solution compared to the proposed alternative to reinforce and extend AC transmission systems in Northern Germany alone.

The large sums involved for grid connection, grid extension and reinforcement pose the question whether they will be borne by the electricity producers who cause them, which would significantly affect their competitiveness, or by the network operator who will recoup them from consumers through the general network tariff and thus socialise them. These options are referred to as either “deep” or “shallow” cost integration. There are advantages and drawbacks to both modes of allocation. The comprehensive study financed by the European Commission on the financing of grid extensions for renewables known as GreenNet-Incentives provides in its “Action Plan” a summary of the arguments (EC, 2009). It begins by differentiating further between “shallow” and “super-shallow” integration as follows:

- *Deep integration*: Based on this approach, costs for grid connection as well as grid reinforcement and extension are allocated to the developers of a new generation plant and add to their overall long run marginal costs.
- *Shallow integration*: Applying a shallow grid integration approach, developers bear the grid connection costs, whereas costs for grid reinforcement and extension costs are attributed to the grid operator and eventually socialised via grid tariffs.
- *Super-shallow integration*: Following this approach, all costs resulting from grid connection, reinforcement and extension are allocated to grid operators and socialised via grid tariffs.

The GreenNet-Incentive Action Plan is in favour of deep integration for the provision of locational signals, i.e., the provision of incentives to minimise the joint costs of production, transport and distribution. This is a crucial issue in connection with renewable energy, especially offshore wind. Load factors can be very favourable, for instance, far off the coast, the only issue being that transportation costs will become quickly prohibitive as the distance from consumption centres increases. On the other hand,

the Action Plan mentions that deep integration, which in fact is akin to vertical integration, might be perceived as running counter to the European Union's complex rules on unbundling in the electricity sector (*ibid.*, p. 15).

The question is whether the combined provision of networks and transport services would lead to suboptimal provision, which was the original rationale for organising the supply of grid services in OECD countries in the form of a regulated monopoly.<sup>5</sup> However, such concerns are unfounded if transport services concern a single or very few, identifiable producers, since in such cases no positive externalities are created. Thus the unbundling logic does not apply to the connection of offshore wind-farms.

Thus deep integration would not lead to the duplication of transport investments for projects that are in the vicinity of each other as argued in the Action Plan. The clear allocation of responsibilities should instead motivate operators to reduce transaction costs and share resources. Neighbouring projects would have every incentive to pool resources for transport links. Deep integration is thus likely to lead to overall cost advantages since it aligns private and social costs.

Socialising cost through shallow integration instead requires recapturing costs via additional rules. In the best case this will lead to additional transaction costs. In the worst case it will lead to regulatory uncertainty, over-investment and bureaucratic inflexibility. First signs of stress are appearing in Germany, the leading market for offshore wind generation, where the installation of grid connections by network operators is increasingly lagging behind the construction of subsidised wind-parks largely due to financing problems (Enerpresse, 2012).

### **Grid dependency**

All electricity sources other than those used for auto-generation require access to the grid in order to transport their electricity to consumers and to restart after a shutdown. However, nuclear energy plants pose particular issues with respect to grid integration due to their size and due to the absolute necessity to have continuous cooling of the reactor core (IAEA, 2009). While the latter can also be provided by autonomous onsite power resources, offsite power is clearly the first line of defence for the provision of cooling. For this reasons, nuclear power plants pose more stringent requirements in term of the stability (voltage and frequency permissible variations) and availability of external power supply. For instance, nuclear power plants require redundant electrical connections with the existing grid, which makes for higher connection costs compared with a thermal plant of equivalent size.

Letting the reactor's steam turbine provide its own electricity in the so-called "island mode" at a fraction of the maximum load is a technically challenging undertaking that implies certain risks of failure in the case of a sudden loss of offsite power. Attempting to work in "island mode", i.e. a reactor producing its own electricity for cooling, is a difficult challenge in normal times and would be inappropriate and potentially dangerous in an emergency situation. In such a case, autonomous sources of onsite power such as diesel generators or "passive systems" driven by gravity would constitute the next line of defence (see also Section 2.3). The general conclusion that the size and the quality of the electricity grid are especially important issues for nuclear power remains thus unaffected.

### **Technical intermittency – short-term impacts (balancing costs)**

Technical intermittency refers to the fact that a power plant is not available at any given moment in order to meet demand. In an industry with only limited means of economical storage this poses a challenge in ensuring continuous supply security for as vital a service as electricity. In particular, it means that back-up capacity from alternative technologies needs to be available for the periods when a given plant is unavailable. Intermittency is an issue primarily for renewable technologies such as wind and solar, which depends on changing weather patterns and leads to comparatively low load factors. (see Figure 4.2).

5. An intermediate model would be constituted by electricity markets with elements of "nodal" pricing, such as the PJM-market in the north-eastern United States. Under nodal pricing, grid investments are still undertaken by the transport system operator. However, the latter charges power suppliers according to the distance and the "congestion" on the particular part of the grid that they are using. This again provides the appropriate locational signals. In practice nodal markets are highly complex to understand and operate. The PJM, for instance, has been characterised by frequent rule changes, which has not contributed to a stable market environment.

In principle, intermittency can affect any technology in the course of so-called unplanned outages. However, the fact that such unplanned outages are substantially uncorrelated across different plants of conventional “dispatchable” technologies such as nuclear, coal or gas, means that allowing for appropriate reserve capacity can deal with them adequately. The issue with variable renewables is that lower wind speeds and cloud cover are likely to affect large shares, if not the totality of the installed capacity of the respective technologies.

At the same time, there is no automatic link between intermittency and the fact that a technology is renewable. Hydropower, biomass, biogas or geothermal energy are all unaffected by the large-scale intermittency that affects wind or solar. Even CSP can with varying degrees of efficiency offer up to several hours of heat storage, limiting the immediate impacts of intermittency.

**Figure 4.2: Daily variations of wind energy in Spain over one year**

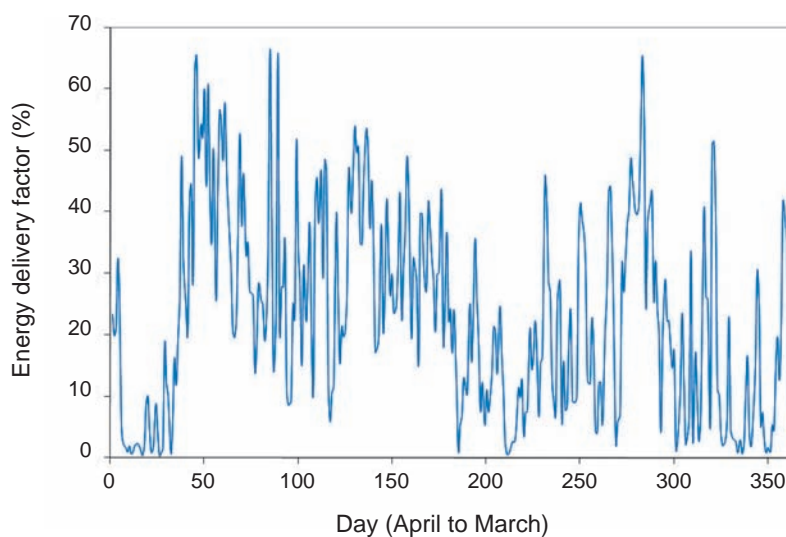

Source: Mabel, Raj and Fernandez, 2010.

The impacts of fleet-wide variability affect the electricity system in terms of both the costs of short-term balancing and the costs of long-term adequacy provision. Balancing is required to maintain second-by-second matching of demand and supply allowing for voltage regulation and frequency response, load following, demand forecasting errors, unplanned generating plants outages and grid-related failures and changes in unit commitment and dispatching. Balancing costs result from the fact that dispatchable capacity needs to be available at a moment's notice in case the supply of variable renewables falls short of the forecasts. Such added operating reserves come in three forms – spinning reserves, supplemental reserves and replacement reserve.<sup>6</sup> Spinning reserves are constituted by conventional power plants that are already up and running but provide load at less than their maximum capacity. In case of need, they can ramp up their load very quickly. Supplemental reserves are constituted by plants that are idle but can be started up in a matter of minutes such as oil- or gas-fired open-cycle plants.<sup>7</sup> Replacement reserves have somewhat longer start-up times of between 30 and 60 minutes.

6. In European electricity markets, one refers habitually to primary, secondary and tertiary reserves, which are also differentiated by the time frame, in which they can be activated, from several seconds up to 15 minutes. The first two are typically activated directly by the transport system operator (TSO) according to the needs of the network according to protocols and payment modalities specified in advance. One should also note that the segmentation of different types of reserves may differ from country to country with a greater or lesser role of market pricing. In general, however, the trend is towards an ever closer integration of market and network operations as witnessed by the creation of hourly intraday trading on Europe's EPEX SPOT platform, which begins to blur the line between the provision of electric load to customers and network stabilisation services.

7. Such plants have the advantage of great flexibility but the disadvantage of low-thermal efficiency and high marginal costs. In the absence of any intermittency issues, they are thus only used during extreme peak times.

Providing short-term reserves for balancing is costly, as both investment and operating costs have to be committed without any corresponding revenue. Additional fuel costs also result from lower thermal conversion efficiencies at reduced power levels. Finally, ramping load up and down adds to the wear and tear of equipment and implies higher operating costs, items that are summarised under the term “ramp costs”. Variable renewables increase the fluctuations that have to be managed by the system and therefore make balancing more difficult. Consequently, balancing costs increase, especially at high penetration levels of variable renewables. Balancing costs for variable renewables are functions of both the unpredictability and the variability. If the forecasts for wind speed and solar radiation could be made with accuracy, there would no longer be a need for additional spinning reserves and balancing costs would consist only of increased ramp costs. Load forecasting for variable renewables has made considerable progress in recent years and has reduced the needs for balancing and the associated costs.<sup>8</sup>

Among the key factors affecting balancing costs are the availability and cost of flexible capacity in the generation mix as well as the size of the interconnected electricity system. The availability of flexible resources with low marginal costs such as hydropower reduces short-term balancing costs. Balancing costs also decrease with the size of the electricity system as larger balancing areas allow for mutualising balancing reserves. In the same vein, interconnecting generation systems with complementary production profiles reduces balancing costs. Clearly, balancing costs vary from country to country as they depend on overall system characteristics, the amount of output variation from variable plants, the rate of this variation (ramping rate) and the correlation with demand. The geographical and technological spread of variable power plants also tends to reduce overall output fluctuations, ramp rates and, consequently, the cost of balancing.<sup>9</sup>

From an economic point of view, the best incentive to reduce the system costs of short-term load balancing would be provided by allocating balancing costs to variable power producers themselves, for instance by obliging them to feed in stable bands of electricity with certain characteristics regarding voltage and frequency control. This would provide an incentive to improve forecast accuracy further as well as to align load with forecasts, adjusting it with the help of dedicated back-up, thus minimising balancing costs. This need not necessarily reduce the competitiveness of variable renewables as long as subsidies were appropriately adjusted. It would, however, provide the appropriate incentive to render system costs transparent and to appropriately internalise them at least cost.

Estimates from different studies indicate that at wind penetration levels up to 20% balancing costs related to unpredictability and uncertainty vary between EUR 1-4/MWh and increase with penetration levels (see Figure 4.3). Some differences can easily be explained. The Norwegian generation power system, for instance, is extremely flexible (high hydro resources), thus increasing from 10% to 20% the level of wind penetration does not increase balancing costs. The case is different for a country such as the United Kingdom, where back-up will be provided by relatively high-cost gas turbines. In general, balancing costs increase more than proportionally with the level of penetration of variable energy sources. This reflects the fact that overall system variability is lower at low penetration levels and the system has relatively more low-cost dispatchable capacity available.

Variable renewables represent the largest but not the only cause for creating balancing costs through the constitution of short-term capacity reserves. All electricity systems operate according to the N-1 rule, which implies that the system must be able to fully meet demand even if any generation plant should suddenly no longer be available due to an unplanned outage. In other words, a given amount of costly spinning reserves is always provided for, independent of any fluctuating production by variable renewables. This amount corresponds to the capacity of the largest single plant, since if it failed, total system production would still need to match demand. In countries with nuclear energy, the largest plant is habitually constituted by a nuclear plant (otherwise it would usually be a coal plant). This

8. The IEA report on integration of renewable energy quantifies in about 30% the potential savings in balancing cost due to better wind forecasts (IEA, 2011b).

9. Vandezande *et al.* (2010) provide an exhaustive list of factors affecting balancing costs which includes the level of variable renewables penetration, the type and marginal costs of reserve plants, the quality and accuracy of weather forecasts, the regulatory and institutional frameworks, the technological and geographical spread of variable renewables as well as the availability of storage, interconnections and demand-side flexibility.



means that in the absence of significant shares of renewable power production, countries with nuclear power would require somewhat larger spinning reserves than countries without nuclear power (see also Chapter 6 on the reduction of the required amount of spinning reserves by switching from large nuclear power plants to SMRs). The amounts are comparatively small, below EUR 1/MWh, but have been included in the quantitative estimations in Section 4.2 for the sake of completeness.

**Figure 4.3: Balancing costs as a function of the share of wind power**

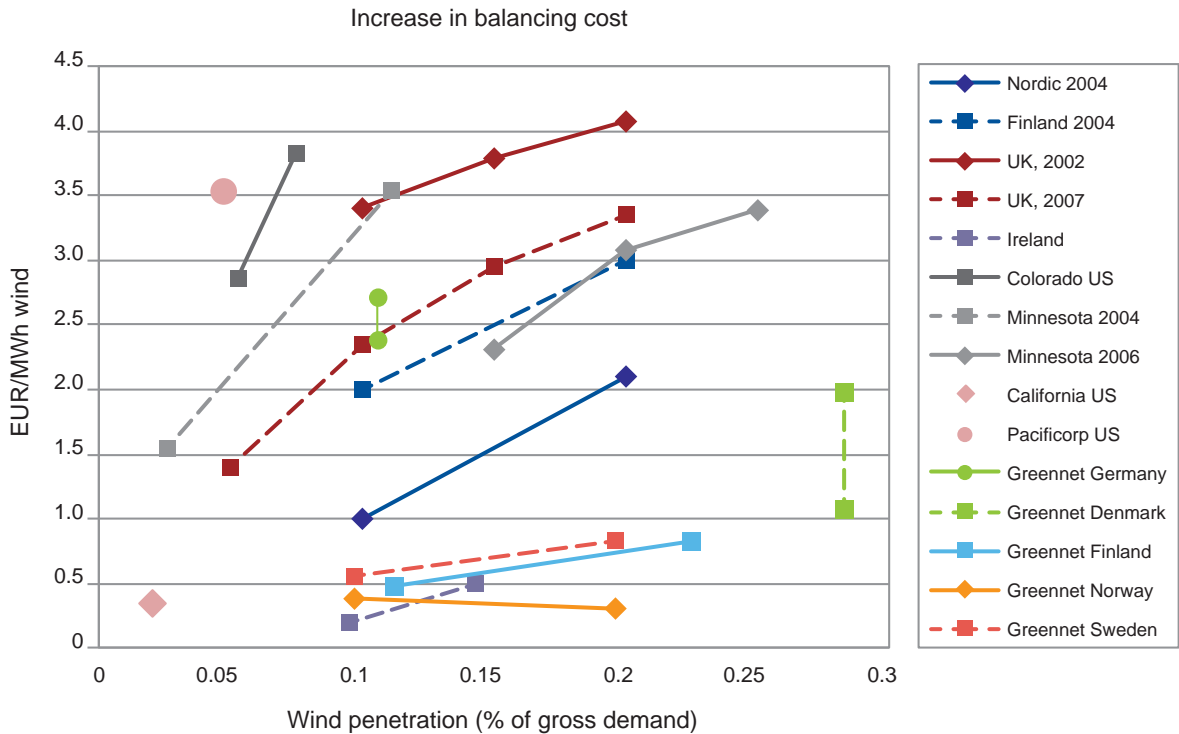

Source: Holttinen *et al.*, 2009.

### Technical intermittency – long-term impacts (generation system adequacy costs)

As discussed in Chapter 2, long-term adequacy measures the capability of an electrical power system to satisfy the load at all times in the future, taking into account the fluctuations on demand and supply, the outages of system components that can be reasonably expected, the projected retirement of generating facilities and the construction of new generating units. Each electricity system operates with high but not 100% reliability: under certain circumstances some customers may not be supplied. In every electricity system the total installed generation capacity thus exceeds peak load to ensure a sufficient level of reliability. The actual capacity margin depends on the expected level of reliability and the characteristics of the individual generating plants.

Each generating power plant contributes, at a different level, to the adequacy of the whole electricity system. Intuitively, variable power plants, wind and solar for instance, do not contribute to system adequacy to the same extent as dispatchable power plants: the probability that the wind is not blowing and the sun is not shining in periods of high demand is much higher than that of an outage of a dispatchable plant. The concept of capacity credit of a power plant is used to measure its contribution to the adequacy of the whole electricity system (see Box 4.2).

### Box 4.2 Capacity credit and the “real” costs of generation adequacy

The capacity credit, or capacity value, of a power plant can be defined as the amount of additional peak load that can be served due to the addition of the generator, while maintaining the existing levels of reliability (adapted from IEEE, 2011). Capacity credit is often measured as a fraction of a power plant’s nominal capacity. Variable renewable energies such as wind or solar photovoltaics technologies have much lower capacity credit levels than conventional sources of energy such as coal or nuclear energy, which have capacity credits fairly close to one.

The level of capacity credit depends on several parameters such as the average load factor, its day-to-day variance and the level of targeted security of supply. However, the most important factor is the correlation of load with peak demand. For instance, solar technology may have a high capacity credit in a country where the peak load is in summer around mid-day (due to air conditioning), when solar output is maximal. A study of the Solar Electric Power Association for three locations in the United States shows that the capacity credit of solar PV is even higher than its load factor (!) for the three locations in question, where the peak demand occurs indeed at mid-day in summer time (SEPA, 2008). Figure 4.4 clearly illustrates this effect in the Californian CAISO system, where solar capacity credit of the first 6 GW installed is almost 50%. On the other hand, solar technologies may have almost zero capacity credit if the peak demand occurs in the evenings during winter, as in several north European countries, especially those relying heavily on electric heating such as France.

**Figure 4.4: The declining contribution of increasing amounts of solar capacity to system capacity in the Californian CAISO system**

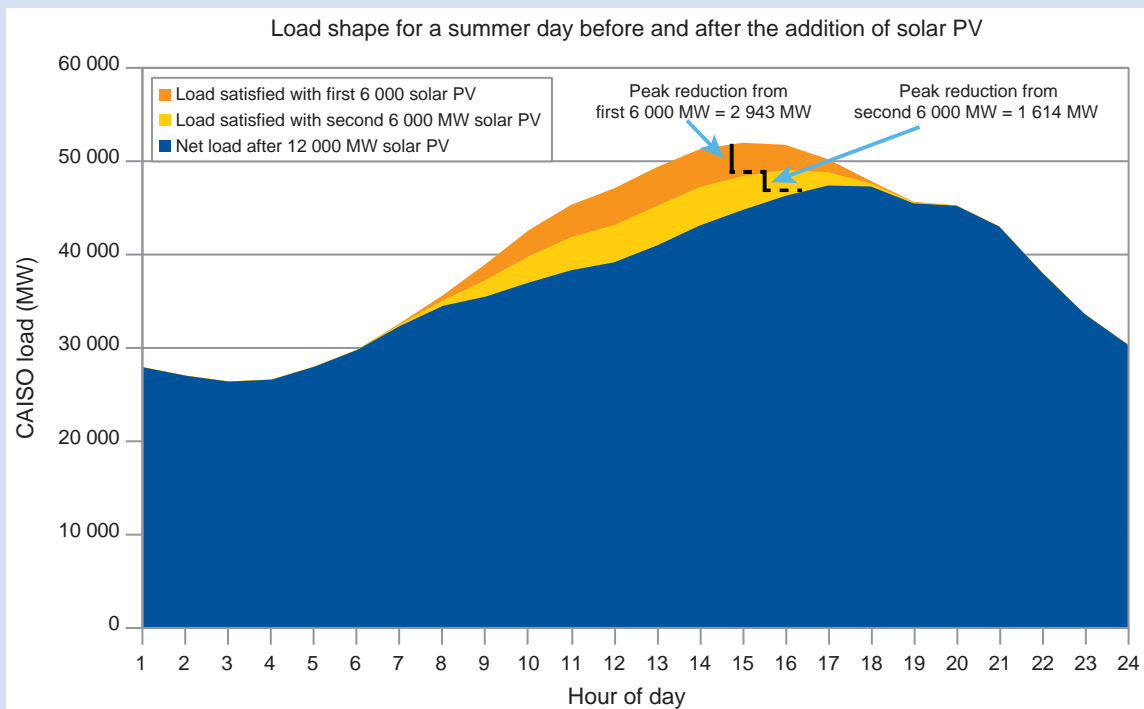

Another key factor influencing the capacity value is the correlation between the output of a given plant and that of the rest of the electricity system. Dispatchable plants for instance are weakly correlated and their capacity credit can thus be higher than their respective load and availability factors: their planned outages are scheduled during periods of weak electricity demand, while they are supposed to be available during high demand periods. On the contrary, variable renewables relying on the same natural resource are closely correlated (one wind turbine is likely to stop turning the very moment that other turbines stop turning). Thus, the capacity credit of variable renewable power plants decreases with the penetration level, reflecting the increased correlation with the rest of the generating system.

Calculating capacity credits is a complex undertaking which requires the use of advanced statistical modelling. The Institute for Electrical and Electronic Engineers reports five different approximated methodologies for calculating the capacity credit (IEEE, 2011). The study also shows that different methodologies can lead to significant discrepancies in the final capacity credit values. The Solar Electric Power Association counts and compares eight different methods for calculating the capacity credit of solar PV (SEPA, 2008). The NEA developed a robust and transparent but relatively simple method based on Monte Carlo simulations to calculate capacity credit (see Appendix 4.C). This method has been used in this study to determine the capacity credit for those countries where no other detailed studies were available.

In practice, variable renewables, although providing the same electricity output, cannot guarantee the same reliability level to the electricity system as dispatchable technologies. For that reason, covering new electricity demand with variable generators generally requires the construction of additional “back-up” capacity in order to maintain the target reliability levels of the electricity system. Adequacy costs account for all investment and operating costs required for providing the additional capacity. Depending on circumstance, the costs for assuring long-term generation system adequacy are often considerably larger than those for short-term balancing needs.

However, if calculating the capacity credit of a single power plant is a complex task, quantifying the “real” costs for adequate back-up capacity is an even greater challenge. A crucial question is whether these costs can be considered as already paid off or whether they must be considered as new costs that need to be included in the system costs of variable renewables. An existing system whose conventional capacity is already capable of covering demand at all times, will not have to install new back-up capacity for variable renewables before the replacement of the existing plants is due. An electricity system, however, which plans to cover new demand with variable renewables will have to install and pay in full for dispatchable back-up capacity minus the capacity credit.

The first case, which has been defined throughout this study as *ex post*, reflects the present situation in many European countries, where variable renewables have been introduced into electricity systems that had already sufficient capacity to respond to present electricity demand.<sup>10</sup> In that case there is no need to build any additional capacity and the adequacy costs are, at least in the short run, equal to zero. Thus, adding new generating capacity to the electricity system, even if variable, improves the overall system capability to meet the electrical demand.

The situation is different if new generating capacity is built in order to satisfy new electricity demand, to replace existing plants or it has been fully anticipated by the market. This case is defined in this study as *ex ante*. Here, new generating capacity needs to be built and variable capacity simply displaces investments in other technologies. In this case, some additional dispatchable units must also be built in order to ensure the targeted reliability level of the whole electricity system. The key question is now how much of this dispatchable back-up capacity needs to be built and at what cost. Costs will vary depending upon what generation form is assumed to provide the back-up services. This study reflects this reality by producing two figures for the cost of providing long-term back-up. The *ex post* case thus calculates the system costs for a system where adequate conventional capacity already exists and the introduction of additional capacity does not require any back-up capacity. Thus, adequacy costs are equal to zero. The long-term *ex ante* case instead calculates the system costs where such conventional back-up capacity still needs to be installed, assuming that no “unused” capacity is present in the system.

In the context of the NEA system cost study, an energy-normalised approach has been adopted for calculating the additional capacity that has to be built and to determine the related adequacy cost. Using this approach, adequacy costs are assessed as the investment costs in new back-up technologies needed to close any gap between the capacity credit of a given technology and that of the existing generation mix that would provide the same electrical output. In this way, the new system will guarantee the same service, in term of both electricity production and security of supply, as that of the existing generation mix.

10. See Box 4.3 for a more extensive definition of the long-term *ex ante* and the short-term *ex post* cases.

A particular difficulty in this context is to determine the optimal generation mix that would guarantee that this service is provided at the least cost. In a traditional electricity system, where reserve back-up capacity is supposed to be called upon very infrequently and the amount of renewables is small, the optimal solution would be based, in the absence of storage or demand-side management (DSM), on the technology with the lowest investment costs (open cycle gas turbines or oil-fuelled power plants). However, this simple approach might not hold at very high penetration levels of renewables. As the number of hours at which the back-up technology is called upon increases, the optimal mix for back-up capacity would continue to include some mid-load or even baseload power plants.<sup>11</sup> Also, political choices of individual countries might favour a solution for the back-up capacity that would differ from the economical optimum.

### **The financial impacts of intermittency: the compression effect**

Electricity produced from sources with low marginal costs reduces the operating hours and thus the load factor of conventional power plants. This effect is known as the “compression effect”. It also reduces the average price of electricity as the merit order shifts to the “right” (see Figure 5.7) towards technologies with lower variable costs. Both factors reduce the profitability of existing plants and will lead to inadequate incentives for future investments.

The compression effect is a key system effect of subsidised renewables since it affects the profitability of conventional, dispatchable technologies, which are an indispensable element of the security of systems with large amounts of variable renewables since they provide the dispatchable back-up capacity that is necessary for the continuity of supply. Chapter 1 already asked the question to which extent such pecuniary externalities constitute a welfare relevant issue or are just a result of the normal working of competition. It was explained that a significant suboptimality arises from two sources:

- Variable renewables are subsidised, frequently through feed-in tariffs, and their deployment is thus isolated from the lower average electricity price they themselves generate. One thus faces the one-way causal link without any feedback mechanisms that is typical for welfare-reducing externalities.
- Dispatchable conventional technologies are required to provide an essential service for the stability of the system, i.e. the provision of capacity for power production during periods of low renewable production as well as a system services such as reactive power.

For the time being, the compression effect is receiving only very limited attention from experts and policy-makers although it is increasingly being felt, in particular in Germany and Spain, where due to strong renewable production, CCGT gas plants are becoming increasingly unprofitable due to their low load factors. Given that much of the necessary conventional back-up capacity is available in OECD countries and will provide the required electricity in time of need, the compression effect and the resulting lower electricity prices seem to provide a welcome benefit for electricity consumers. This, however, will change rapidly the moment that new investments in dispatchable capacity will be necessary, either because existing capacity has reached the end of its operating lifetime or because new demand will have to be satisfied.

There exist two complementary solutions for the challenge of the compression effect. The first is the creation of a feedback mechanism between variable renewables and market prices. This could be done either by switching from stable feed-in tariffs to feed-in premiums that provide a fixed mark-up over market prices or from subsidies for deployment rather than for production. Both would provide renewable producers with an incentive at least not to produce at maximum capacity in times of negative prices and thus provide better remuneration also for dispatchable capacity. The second solution is to remunerate conventional technologies not only for the power they produce but also for the essential system

11. The question may be legitimately asked to which extent such dispatchable technologies that are called upon more often than, say, 3 000 hours per year would still be thought of as back-up capacity or simply as alternative electricity providers. The very question, however, shows how scenarios with very large shares of intermittent renewables, say above 30% of electricity production, begin to require adjustments that create intrinsic ceilings to the original objective.

service they contribute through the provision of dispatchable back-up capacity. Electricity markets in many OECD countries already allocate capacity payments of one sort or another (not all motivated by the impacts of variable renewables) and several others are considering it.

Capacity markets are complex, are characterised by considerable transaction costs and can cause unforeseen impacts through the interaction with electricity markets, nevertheless they constitute at least a partial solution to the problem of capacity provision. One question that urgently needs to be addressed in the near future is the extent to which the combined impact of the compression effect and capacity markets affects different dispatchable technologies in different ways. The compression effect, for instance, will affect capital-intensive technologies such as nuclear more significantly than less capital-intensive technologies such as gas.

Section 4.3 will provide some empirical estimates of the compression effect for different dispatchable technologies. It highlights, in particular, that the impact of the compression effect depends heavily on the time frame under consideration. In the short run, when the structure of electricity systems is fixed, especially high variable cost producers such as gas will decrease market share as a result of lower average prices. In the long run, however, when new investments must be considered, reduced load factors mean that investors have a tendency to turn away from capital-intensive high-fixed cost, low-carbon technologies such as nuclear.<sup>12</sup> Eventually there will be a trade-off between lower load factors and higher carbon prices. The final re-configuration of the power system will be determined by the compression effect in conjunction with the carbon price. However, it is already clear now that in markets with significant amounts of renewable energies, the role of nuclear energy will be shaped increasingly by its quality of being the only dispatchable low-carbon provider of electricity.

### Security of supply<sup>13</sup>

Together with greenhouse gas emissions, local environmental impacts, siting and land use as well as safety, the impact of a given technology on the security of supply is part of its total cost. Contrary to the different elements of grid costs, such items cannot be systematically quantified since their valuations depend on social and political processes that constantly integrate complex, multi-dimensional preferences evolving through time. Nevertheless they contribute to the broader well-being of the citizens of a given country and deserve to be taken into account in the decisions of policy-makers.

A recent NEA study on *The Security of Energy Supply and the Contribution of Nuclear Energy* (2010) distinguished between an external and an internal dimension of energy security. In terms of the external dimension, nuclear and renewable energies hold distinctive advantages over fossil fuel-based technologies. With more than 90% of its inputs in terms of value sourced domestically, nuclear power can be considered a largely domestic source of energy and electricity. Of course, a majority of OECD countries import part or all of their requirements of uranium. However, these imports frequently come from other OECD countries. Even where supplies come from non-OECD countries, they are geographically well distributed and have never given rise to security of supply issues in the past.

For uranium, the majority of supplies are coming from politically stable OECD countries such as Australia and Canada. The only major geopolitical change in the supply of uranium is rapid mining development in Kazakhstan. According to *Uranium 2011: Resources, Production and Demand* (NEA/IAEA, 2012), in 2010 Kazakhstan became the world largest uranium producer (17 803 tonnes, i.e. 32.6% of the global production), followed by Canada (9 775 tonnes) and Australia (5 918 tonnes). OECD countries supplied about 32% of the global uranium production in 2010. Nevertheless, one can state that the uranium supplies used in nuclear energy production do not pose any major risk to energy security.

12. Renewable energies, which are the ultimate high-fixed cost, low-carbon technologies, would be subjected in absence of fixed feed-in tariffs to precisely the same effects. In a market without subsidies this would quickly establish a ceiling on the amounts of renewables in the market place, as the low electricity prices resulting from their low variable costs would adversely affect their profitability per MWh of produced electricity.

13. The following paragraphs include material drawn from NEA (2010).

Overall, in the face of geopolitical supply risks, whether due to import dependence, resource exhaustion or changes in the global carbon regime, nuclear energy as well as renewable energies hold advantages that other fuels such as oil, coal and gas do not enjoy: wide availability of resources for a long time to come and modest impacts of increases in resource prices.

An additional aspect of the external dimension of security of supply is the vulnerability of a given technology to a sudden tightening of the global or national carbon regime. Contrary to coal and natural gas, low-carbon technologies such as nuclear and renewables would be unaffected by a sudden tightening of policy restrictions on the emission of greenhouse gases. This is not a far-fetched hypothesis. The great majority of long-term energy scenarios assume reduced greenhouse gas emissions and a substantial expansion of nuclear power.

The contribution of a given technology to the *internal* dimension of security of supply instead is closely linked to the results of this study. A technology that uses existing grid capacity in the most efficient manner and does not impose any negative externalities on other technologies contributes, other things being equal, more to the security of electricity supply, than one that does. Quite obviously, dispatchable and variable resources diverge widely with respect to this internal dimension. Variability destabilises the electricity system both with respect to network operations and with respect to the economic viability of dispatchable back-up technologies, which nevertheless remain necessary to ensure the matching of supply and demand.

If security of supply includes not only the physical availability of a resource but also its affordability and the stability of its prices, nuclear energy provides further advantages, as once built its costs remain stable and move little in response to changes in the fuel or the carbon price. Nuclear energy, which shares this quality with renewables, is protected against fuel price changes by the low proportion of fuel costs in the LCOE from nuclear power generation. With fossil fuel plants instead investors and customers are exposed to fuel and carbon price risk. For a gas-fired plant 70-80% of its total costs are fuel costs. The Achilles' heel of coal instead is the carbon price. Doubling the carbon price, for instance, from USD 30 per tonne of CO<sub>2</sub> to USD 60 per tonne would increase the total average cost of coal-produced power by 30%, more than doubling its variable cost in the process.

From a security of supply perspective, nuclear power is a technology that combines attractive characteristics in the external and the internal dimension, including the aspect of cost stability. This is reflected in the good security of supply performance of OECD countries with significant investments in nuclear energy during the 1970s and 1980s as measured in terms of the Simplified Supply and Demand Index (SSDI).<sup>14</sup> Figure 4.5 from the NEA study on the security of energy supply shows how countries such as Finland, France, Sweden or the United Kingdom improved their security of supply situation during the past 40 years. While any composite indicator is the product of its defined inputs (which are explained in detail in NEA, 2010), it is clear that nuclear energy has very attractive security of supply characteristics.

14. The Simplified Supply and Demand Index (SSDI) for measuring the contribution to the security of supply of different technologies was developed by the OECD Nuclear Energy Agency in the context of its study on *The Security of Energy Supply and the Contribution of Nuclear Energy* (NEA, 2010). It is based on the Supply/Demand (S/D) Index developed by Scheepers, Seebregts, de Jong and Maters at the Energy Research Center of the Netherlands (ECN) and the Clingendael International Energy Program (see Scheepers *et al.*, 2007). The great advantage of the NEA's SSDI is its adaptation to the structure of the time series of energy statistics available at the International Energy Agency (IEA). It is thus the only currently available indicator capable of tracking consistent data relevant to the security of energy supply over a 40-year time frame that is comparable between OECD member countries.

Figure 4.5: SSDI of selected OECD countries between 1970 and 2007

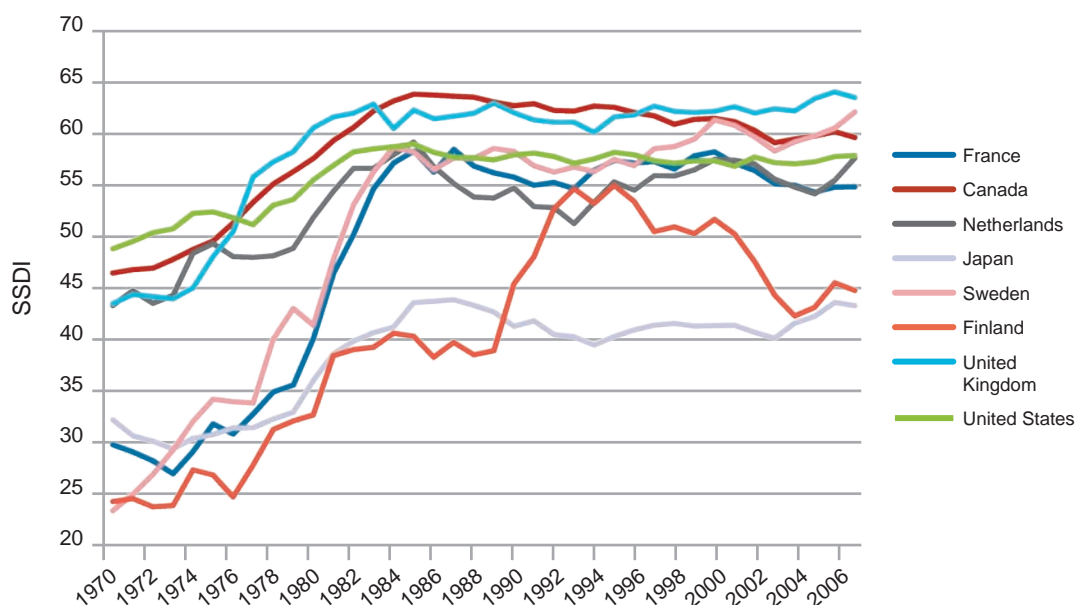

### Greenhouse gas emissions, local environmental impacts and land use

The debate about external effects and thus ultimately also about system effects and grid effects in the electricity sector was initiated by concerns about the environmental impacts of electricity production. In particular local and regional impacts due to the emissions from fossil fuel combustion (particulates,  $\text{SO}_x$  and  $\text{N}_2\text{O}$  and  $\text{NO}_x$ ) were analysed in early studies in the late 1980s and early 1990s. With climate change becoming a major issue after the Rio Earth summit in 1992, greenhouse gas emissions became a new focus in studies on the external effects of electricity. In the power sector, greenhouse gas emissions are mainly constituted by carbon dioxide ( $\text{CO}_2$ ) or carbon emissions that are generated by fossil fuel combustion, although the production and transport of natural gas emits methane ( $\text{CH}_4$ ), an even more potent greenhouse gas, though precise quantities are more difficult to estimate.

On a lifecycle basis, that is including construction and decommissioning in addition to operations, all power generation technologies produce some emissions. The magnitude of these indirect emissions depends on the composition of the energy that is used in producing key inputs such as steel and cement. Figure 4.6 provides an overview of the direct and indirect carbon emissions of different power generation technologies. It shows that indirect carbon emissions of all technologies are at least an order of magnitude lower than the direct emissions from fossil fuel combustion.

The environmental impacts of power generation, however, go beyond emissions. It includes the warming of rivers and lakes due to the cooling requirements of large thermal power plants, in particular nuclear plants, as well as the landscape impacts of renewables with large requirements in terms of land use such as wind, solar and hydro.<sup>15</sup> In case of biomass-firing, it is important that woodlands are forested sustainably. The European project on the *Cost Assessment for Sustainable Energy Systems (CASES)* draws together much of the available information on the external effect of power generation in monetised form. While here is not the place to discuss the merits, limits and proper utilisation of the monetisation of external effects, such synthetic estimates if carefully prepared provide a good qualitative indicator of the areas in which policy action might be needed. Table 4.3 thus shows that the combination of direct health impacts and climate change risks weigh heavily on the attractiveness of fossil fuels, in particular coal. While biomass is carbon-neutral if it is harvested sustainably, it can have significant health impacts due to local and regional particulate emissions.

15. For nuclear power plants, the siting issue has been dealt with extensively in Chapter 2 of this study as part of the system effects of nuclear power.

Overall, nuclear and renewable energies (with the exception of solar PV) compare rather favourably with fossil fuels in terms of the estimates of their external environmental impacts. While such estimates provide indications of orders of magnitude rather than precise measurements of impacts, they nevertheless contribute to a more balanced view of the impacts of different power generation technologies.

**Figure 4.6: Direct and indirect CO<sub>2</sub> emissions of different power generation technologies**

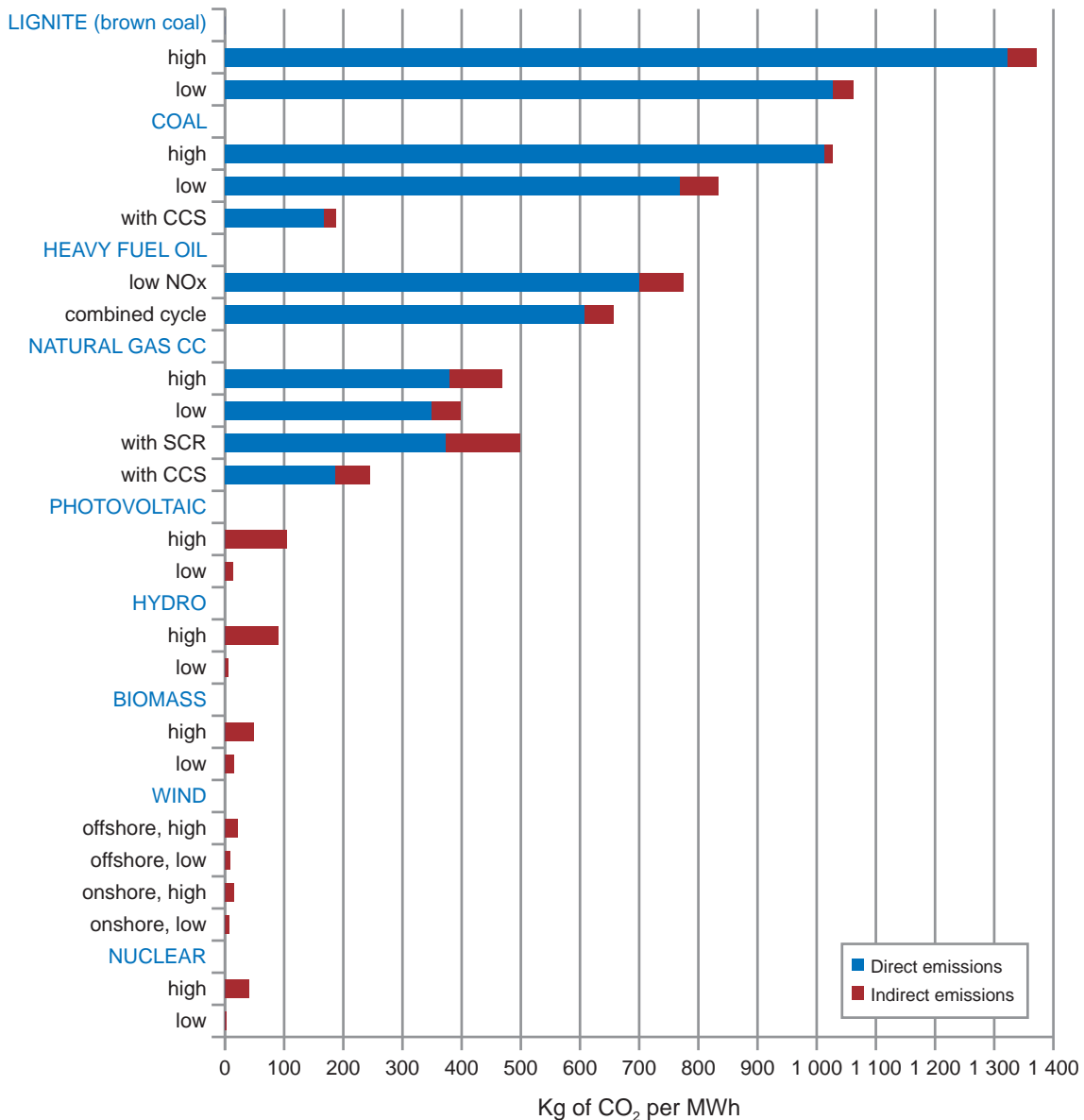

Source: IPCC, 2007.



**Table 4.3: The external costs of electricity in Europe from 2005 to 2010\***  
(EUR/MWh in EU 27)

	Nuclear	Coal IGCC	Lignite IGCC	Gas CCGT	Hydro (dam)	Wind onshore	Wind offshore	Solar PV	Biomass (straw)	Biomass (wood)
Human health	1.55	8.35	3.84	4.24	0.57	0.75	0.72	6.58	15.55	4.64
Loss of biodiversity	0.09	0.79	0.32	0.52	0.02	0.04	0.03	0.34	2.94	0.49
Crops (N, O <sub>3</sub> , SO <sub>2</sub> )	0.02	0.15	0.04	0.12	0.01	0.01	0.01	0.07	0.1	0.13
Materials: SO <sub>2</sub> & NO <sub>x</sub>	0.03	0.11	0.03	0.07	0.01	0.01	0.01	0.09	0.12	0.07
Radionuclides	0.02	0	0	0	0	0	0	0	0	0
Climate change	0.43	17.56	19.57	8.97	0.16	0.21	0.17	1.81	1.46	1.2
<b>Total</b>	<b>2.14</b>	<b>26.96</b>	<b>23.8</b>	<b>13.93</b>	<b>0.76</b>	<b>1.03</b>	<b>0.94</b>	<b>8.88</b>	<b>20.17</b>	<b>6.54</b>

\* High external cost values for solar in the NEEDS analysis are due to the human health effect of the NO<sub>x</sub>, SO<sub>2</sub> and particulates emission during construction and operation as well as on the CO<sub>2</sub> emissions during construction.

Source: [www.feem-project.net/cases/links\\_databases.php](http://www.feem-project.net/cases/links_databases.php), formatting adapted by NEA Secretariat.

### Subjective and objective safety

The issue of the safety of different power generation technologies encompasses two different aspects, the subjectively perceived safety of a given technology, which is closely linked to its public acceptance, and its objective, statistical risk. The relationship between the two aspects is complex. On the one hand, it is quite evident that the link between the performance of a technology in terms of the magnitude and frequency of its risks and its public perception is tenuous. Headline events such as the March 2011 Fukushima Daiichi accident, a breaking dam, or catastrophic storm activity linked with climate change, strongly impact public perception in the short run, often to peter out in the longer term. Recurring events instead, even if large, such as coal mining accidents or gas explosions leave a much smaller imprint on the public psyche, which suggests that familiarity creates a kind of fatalistic acquiescence.

On the other hand, the relationship between the two aspects cannot simply be reduced to an opposition between the “objective” performance of a technology as determined by experts according to neutral protocols and an uninformed public. There are good reasons why subjective statements need to be taken seriously, to some extent independent of objective measurements, although better communication of the latter should, of course, influence the former:

- To the extent that stated risk perceptions determine behaviour (“revealed preference” being the only standard for the veracity of a personal statement from an economic point of view) they are objective in the sense that they measure true unease or pain.
- “Objective” statistical measurements frequently provide accident risks in terms of mortality and morbidity on a per MWh basis. While this is fundamentally important information, it assumes, in the absence of further refinements, risk neutrality and does not take into account important qualities of human risk preferences:
  - A preference for high frequency and comparatively low impact risks over low frequency and comparatively high impact risks (risk aversion);
  - A preference for autonomously contracted and individually remunerated risks with some level of control (say, a miner having chosen to work in a well-paid high-risk profession) over passively endured and socialised risks.

Traditionally, nuclear energy has been the one power generation technology that has most crystallised public opinion and pitted objective performance against subjective risk perceptions. For reasons that cannot be explored in this context and which have to do also with the history of nuclear science – the dual use of many of its foundations and the fear of proliferation rather of concrete accident –, nuclear power has always been perceived as a comparatively risky form of technology. Figure 4.7, which has been adapted from the 2010 Eurobarometer, shows that even before the March 2011 accident at Fukushima Daiichi, a majority of Europeans considered nuclear constituting “some risk” or even “a big risk” for themselves and their families despite the good “objective” results reported in Table 4.4.

**Figure 4.7: “To what extent do you think that nuclear power represents a risk to you and your family?” (EU 27, September-October 2009)**

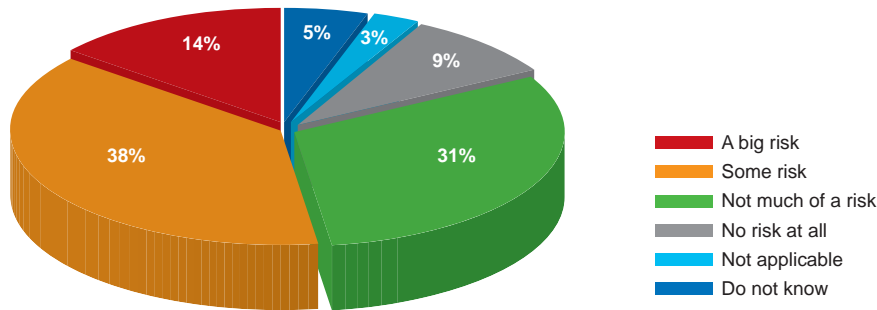

Note: Adapted from EC, 2010.

In reality, there has not been a severe accident in a European nuclear power plant, while there have been several dozen severe accidents associated with coal, oil and gas (see Table 4.4). Even the nuclear accidents at Three Mile Island and at Fukushima Daiichi, firmly embedded in the public consciousness, caused less than five immediate fatalities. And although significant amounts of radioactive isotopes were released at Fukushima Daiichi, in neither case were any of the fatalities attributable to radiation, nor is it expected that any future fatalities will be. The case is not the same for the Chernobyl catastrophe. This is not the place to review the different estimates of the numbers of victims. It can be said that immediate victims are in the dozens and latent fatalities estimated in the thousands. Regarding the latter, there exist large uncertainties. Much depends on whether Chernobyl is viewed as the result of a singular conjunction of technical, human and institutional failures or as the indicator of an incompressible risk residual connected with nuclear power.

**Table 4.4: Severe accidents with at least five fatalities from 1970 to 2005**

Energy chain	OECD		EU 27		Non-OECD		World total	
	Accidents	Fatalities	Accidents	Fatalities	Accidents	Fatalities	Accidents	Fatalities
Coal	81	2 123	41	942	1 507	29 816	1 588	31 939
Oil	174	3 338	64	1 236	308	17 990	482	21 328
Gas	103	1 204	33	337	61	1 366	164	2 570
LPG	59	1 875	20	559	61	2 610	120	4 485
Hydro	1	14	1	116	12	30 007 (a)	13	30 021
Nuclear	–	–	–	–	1	4 031 (b)	1	4 031
<b>Total</b>	<b>418</b>	<b>8 554</b>	<b>159</b>	<b>3 190</b>	<b>1 950</b>	<b>85 820</b>	<b>2 368</b>	<b>94 374</b>

(a) The Banqiao and Shimantan dam failures of 1975 in China together caused 26 000 immediate fatalities and 126 000 indirect fatalities due to epidemic and starvation (Wayne, 1999).

(b) According to WHO Factsheet 303 ([www.who.int/mediacentre/factsheets/fs303/en/index.html](http://www.who.int/mediacentre/factsheets/fs303/en/index.html)) the Chernobyl accident caused 28 immediate fatalities due to radiation (to which 3 immediate fatalities due to the explosion itself must be added) as well as up to 4 000 potential latent fatalities due to cancer among the most heavily affected groups of population (“liquidators”, evacuees and people living in the “strictly controlled zone”). The latter figure was derived by a WHO Expert Group based on the linear no threshold methodology adopted by the International Commission on Radiological Protection. It corresponds to a 3-4% increase in the number of cancers that would have been likely to happen otherwise in the concerned groups.

Source: Wayne, 1999.

The European public itself appears particularly unsure about its own attitudes towards nuclear power. The Eurobarometer 2010 shows that the majority of respondents in every single European country feels either “not very well informed” or “not at all informed” (EC, 2010, p. 88) and a large majority of

EU citizens (63%) considers the information the media offers as insufficient to “draw your own conclusions on the risks and benefits of energy choices in general and nuclear in particular” (*ibid.*, p. 94). This does not only concern the absolute level of information but also the bias of information. Figure 4.8 shows that less than one in ten respondents believe that nuclear risks are perceived correctly. While the percentage of those who think that they are underestimated is slightly larger than the percentage of those who think that they are overestimated, the overall picture is one of fluidity and uncertainty.

**Figure 4.8: “Compared to other safety risks in our lives, would you say that nuclear risks are...?”**  
(EU 27, September-October 2009)

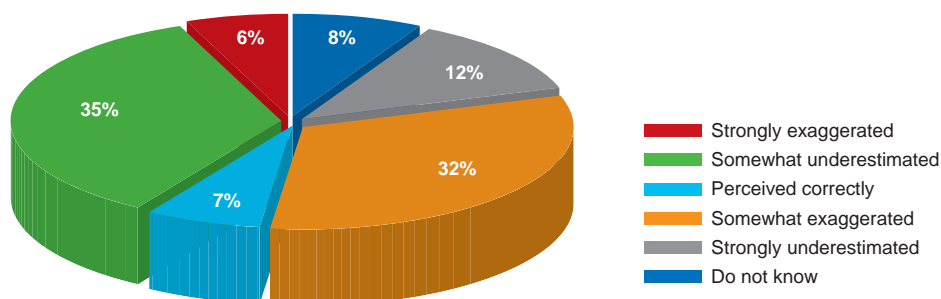

Source: Adapted from EC, 2010, p. 45.

In summary, the objective and subjectively perceived risks of different power generation sources are part of their total system costs or external costs. They make for two interrelated but ultimately distinct subjects of research. While nuclear energy has been traditionally at the forefront in these debates, the most valuable future research in this area would include three distinct items: an even-handed comparative study of the objective statistical performance of different power technologies, the possibility for individuals to control or affect risk exposure and, finally, the historic perceptions and imagery associated with different power generation technologies in the collective conscience. Having all three elements at disposal would indeed permit the beginning of a constructive debate on the objective and subjective risk performance of different power generation technologies.

## 4.2 Quantitative estimation of system costs for selected OECD countries

The introduction of new generating capacity into the electricity system entails costs and benefits. Costs includes the capital and operating costs of the new plant and all the additional investments and operational costs that are required to maintain the same level of security and stability of electrical supply. The latter, as presented in the previous section, include the investment needs for connecting the new plants to the grid, the reinforcements or extension of the existing transmission grid, as well as the costs for short-term balancing requirements and for ensuring long-term adequacy of electricity supply. Additional, though less easy quantifiable, benefits include the savings from fuel and other variable costs associated with the reduced use of less efficient plants and capital cost savings from any power plant that could be displaced.

The assessment of both costs and benefits is strongly context-specific. The composition of the generating mix, fuel costs, cost of reserves and balancing provisions, location of the existing and new capacity with respect to the load, availability of interconnections with neighbouring countries, all have an impact on system costs and benefits. Those elements are specific to national electricity systems and results cannot be easily transposed from a country to another. An additional aspect that must be taken into account is that, especially for variable renewable energy, system integration costs do not vary linearly with the amount of new capacity installed but tend to increase significantly with the penetration level.

### Box 4.3 Short-term vs. long-term approach

From a methodological viewpoint, when assessing prospective costs and benefits arising from the introduction of additional capacity it is important to distinguish between a short-term and a long-term perspective. Electricity production is quite inelastic in the short term: existing power plants have long lifetimes and building new capacity requires a considerable lead-time as well as significant investments. In other terms, electricity systems are locked-in with their existing generation mix and cannot quickly adapt it to changing market conditions. In discussions about the costs of back-up capacity this is also referred to the *ex post* case. In the long term instead electricity companies can adapt their generation mix to new market conditions, resulting from changes in demand, fuel prices as well as the introduction of new capacity into the electricity mix. This was referred to as the *ex ante* case, as the analyst places him/herself at the very beginning of the investment cycle which can now be optimised.

In particular, the introduction of new capacity in the form of low marginal cost variable sources, significantly affects all existing generating plants. These effects, however, depend strongly on the specific characteristics of each generating technology and on the time frame considered. For a given technology, the effects will differ considerably in the short term and the long term. As will be shown in Section 4.3, in the short term all generating technologies experience a reduction of load factors and profitability (compression effect) with high variable costs technologies such as gas being particularly affected. In the long term, the introduction of renewable technologies affects primarily baseload technologies, while the effect on the other dispatchable technologies is limited. Also, their impacts on other important parameters such as electricity prices and carbon emissions are very different in the short term and in the long term.

In order to correctly account for those time frame differences, in the present study we consider two different scenarios, based on a short-term and a long-term approach. In a **short-term ex post scenario**, we assume that the introduction of new generating capacity in the existing electricity system occurs almost instantaneously and has not been anticipated by market players. The new renewable capacity is simply added to a system which is already capable to satisfy a stable electricity demand with a targeted level of reliability. In the **long-term ex ante scenario**, the analysis is situated in a future where new renewable capacity is introduced over time, old existing capacity is retired and all market players have been able to adapt their generating mix to the new market conditions; in other words the country electricity system is considered as a clean state. In this scenario, new renewable capacity is introduced exogenously and the surrounding system of dispatchable plants will adjust optimally. Throughout this study, the short-term and long-term scenarios are also referred as *ex post* and *ex ante* analysis.

As far as the first wave of renewables deployment in OECD countries is concerned, one can observe a transition from pure short-term reactions (reduced load factors and prices, increased load following, etc.) to long-term reactions (early plant retirement, deferred investments, etc.). Policy-makers thus must act quickly to counteract the increasing threats to the security of electricity supplies that are currently being masked only by the low level of demand due to the sluggish growth of OECD economies.

This system cost study by the OECD/NEA attempts to estimate the costs and benefits of the integration of different generation technologies in six OECD countries: Finland, France, Germany, the Republic of Korea, the United Kingdom and the United States. The study covers three main dispatchable technologies, coal, gas and nuclear, as well as three variable renewable technologies, wind onshore, wind offshore and solar. Also, in order to account for the non-linearity of grid-level system costs, two different penetration levels are considered for each generating technology: 10% and 30% of the country's electricity consumption, respectively.

For this purpose, the NEA Secretariat developed an Excel®-based quantitative model that combines the most recent OECD database on plant-level electricity generating cost with a complete set of grid-based cost, on a country-by-country level. Grid-level costs are drawn from the most reliable and up-to-date international studies, under the guidance of the Working Party on Nuclear Energy Economics (WPNE) Expert Group composed of representatives of OECD governments. The data are then organised in a consistent and coherent manner, using identical economic assumptions and a consistent methodology. The complete data sets and their sources of the NEA model are provided in Appendix 4.A.

Results are presented in four distinct steps which progressively incorporate the system effects into cost-benefits comparisons. The first step considers only plant-level costs, derived using the same methodology as in IEA/NEA study on the *Projected Costs of Generating Electricity* (see Table 4.5). A real interest

rate of 7% and a carbon price of USD 30/tonne are assumed throughout the study.<sup>16</sup> In a second step, the study provides a summary of several estimates of system costs at a grid level in selected OECD countries (Table 4.6). Other than providing a quantitative estimate of system costs, this analysis allows for a direct comparison of plant-level costs and grid-level integration costs for different technologies.

In a third step, this study looks at the total costs of the electricity supply in a given country as a function of the introduction of different levels of variable renewable technologies (Table 4.7). These include not only the plant-level costs and system costs at the grid-level previously considered, but also the benefits deriving from a reduced need of alternative technologies. Table 4.7 thus provides a snapshot of the added social resource costs due to each incremental unit of electricity produced by a newly introduced technology.

Finally, in Section 4.3, the study addresses an important additional effect of the introduction of variable renewables, the de-optimisation of the existing electricity mix. Consistent with the distinctions made in Chapter 1, the study thus attempts to establish first indications of the pecuniary externalities that the introduction of variable renewables imposes on the operations of the existing generation system.

### Plant-level costs

Plant-level costs represent the production costs of a unit of electricity (MWh) averaged over the whole economic life of a generation technology. The LCOE (expressed in USD/MWh) allows to directly compare the production cost of technologies with different cash flows, lifetimes and production profiles. Results are presented in Table 4.5. The differences in plant-level costs for solar reflect capacity factors (often due to regional locations) and investment costs.

The majority of technical and economical data at a plant level have been derived from the last IEA/NEA study on electricity generating costs, the *Projected Costs of Generating Electricity: 2010 Edition* (IEA/NEA, 2010). This large, international study overseen by an expert group of more than 50 international high-level experts of the electricity sector includes country-specific data for more than 200 nuclear and fossil-fuelled baseload plants as well as for a wide range of renewable technologies. Since the IEA/NEA Projected Costs study is the only available data set that offers such a wide range of consistent and comparable data, it was the logical source of data on plant-level electricity generating costs also for this study. The authors readily admit that newer data on individual technologies in individual countries might in the meantime be available. However, integrating this disparate data would have raised a number of difficult methodological and technical questions and would have made the present study vulnerable to accusations of bias in one or the other direction.<sup>17</sup>

**Table 4.5: Plant-level costs**

	Plant-level costs (USD/MWh)					
	Nuclear	Coal	Gas	Onshore wind	Offshore wind	Solar
Finland	73.8	71.6	88.1	111.0	158.4	488.3
France	72.2	85.7	87.3	110.8	143.2	413.4
Germany	67.8	85.7	87.3	119.5	158.4	249.3
Republic of Korea	42.3	69.4	92.3	111.0	174.2	222.3
United Kingdom	86.0	94.3	105.7	113.4	137.4	363.7
United States	63.6	75.5	74.3	93.2	114.2	214.9

16. In IEA/NEA (2010), a carbon price of USD 30/tonne was assumed. Plant-level costs were provided for the two different real interest rates of 5% and 10%.

17. The option of a new edition of the *Projected Costs of Generating Electricity* is currently being considered.

Nevertheless, this study contains a number of notable exceptions. The United Kingdom and Finland did not participate in the last edition of the Projected Cost study. Data for the United Kingdom have largely been derived from the study by Parsons (2011) that was commissioned by the UK Department for Energy and Climate Change (DECC). Plant-level data for nuclear and fossil plants in Finland were derived on the basis of the median values of the Projected Costs study. Finally, due to the rapid decline of the price of PV modules, the investment costs for solar technology have been re-evaluated on the basis of up-to-date estimates by the IEA Renewables Division.

Table 4.2A in Appendix 4.A reports the technology-by-technology specific data used in the model and their origin. It is worth recalling that a real discount rate of 7% and a carbon price of USD 30/tonne have been assumed when computing plant-level costs. Also, the same exchange rate used in the Projected Costs report was adopted in order to ensure consistency among cost data. A value of USD 1.35/EUR has therefore been consistently used in the study and the related Projected Costs study. For the USD/GBP exchange rate the value of USD 1.59/GBP is used, which represents the average market price in the 2011/2012 period.

### System costs at the grid level

In recent years, several studies have been conducted around the world, mainly in Europe and in the United States, with the objective to evaluate the technical feasibility and to quantify the system costs of the integration of variable renewables in the electricity system. The majority of those studies focus on the integration of wind energy, while there are only few reports covering solar energy. However, it is quite difficult to directly compare the results of these studies and thus have a general overview of the system effects in different countries. Each study has a different level of detail, different objectives and often treats only certain aspects of integration. Also, the analysis of system effects is a relatively new area and there do not yet exist standard methodologies for calculating system costs that were internationally adopted. The methodology adopted, key assumptions and the level of detail may thus differ considerably among different studies.

In the following paragraphs, the origin of the data and the different assumptions made in the present study are summarised. Additional information on specific country data and on the methodology used for calculations is reported in Appendix 4.A. Table 4.6 provides the final results on a country-by-country basis.

### Balancing costs

Most of the studies on integrating renewable energy estimate balancing costs in a range USD 1-7/MWh at penetration levels up to 20% and all show a cost increase with the penetration level. The values used in our model lie in that range, with the exception of those for the United Kingdom, above USD 7/MWh at 10% penetration level and double at 30% penetration (Redpoint, 2008). This probably reflects the challenge of balancing wind in small isolated electricity market. No studies have reported balancing costs for solar technology: thus, this study works with balancing costs that are similar to those calculated for wind power. This is not unreasonable: ramping rates tend to be smoother with solar energy, while forecast accuracy is lower (Barth, 2011).

There is no clear definition and assessment of balancing cost from dispatchable technologies: the back-up capacity (spinning reserves) and the capacity margin required in an electricity system serve for coping with different events, such as unexpected demand variations, load losses, grid failures and unplanned outages of dispatchable power plants. It is thus very difficult to directly attribute any balancing cost to a specific dispatchable technology. However, it is common practice to determine the amount of spinning reserve needed based on the size of the larger (or the two largest) power plant in the grid, which is nuclear in all six countries analysed. Based on those considerations, balancing costs have been calculated for nuclear as the costs for providing spinning reserves for a capacity equal to the differential between the largest nuclear power plant in the system and the largest non-nuclear power plant. With this assumption, balancing costs for nuclear are generally less than USD 0.5/MWh, i.e. about 10% of those for variable renewables. For coal and gas technologies, balancing costs are assumed to be zero.

### Adequacy costs

As discussed in the previous section, calculating the capacity credit for variable and dispatchable technologies is a complex undertaking, and there does not exist an internationally adopted methodology. Table 4.3A reports the values of the different capacity credits, together with a detailed explanation of the origins of the data. Most of the values have been derived from national reports or international studies. However, the NEA developed its own method based on a Monte Carlo analysis of the reported production from variable renewables during 2011 in France to estimate capacity credits when no other detailed studies were available.

Capacity credit of dispatchable power plants has been calculated as one minus the unplanned outage rate, as in Holtinnen *et al.* (2009). The assumed unplanned outage rate is of 3% for nuclear and gas power plants and 3.8% for hard coal power plants. Those values, originally derived from the Dena Study I (Dena, 2005) have been adopted for all the individual countries in this study. Capacity credit values for wind range between 6% and 15% for France, Germany and Finland, while they are significantly higher for the United States and the United Kingdom, due mainly to the higher load factors in those regions. Often, the reports do not differentiate between onshore and offshore technologies. The reported capacity credit values have been used for onshore without any adjustment. The capacity credit values for offshore have been adjusted to take into account its higher load factor values.

Regarding solar power, only a few studies in the United States directly calculate its capacity credit, generally at low penetration levels (DOE, 2010). A recent study (Jones, 2012) evaluates capacity credit for PV for the California electricity system, assuming a broad range of solar installed capacity. Resulting capacity credits are quite high with 27% and 11% respectively, which reflects both the high load factors and the good correlation with peak demand in the south west of the United States. Nevertheless these values have been taken without adjustment for the whole United States, where there are likely to be lower. Solar capacity values for France have been obtained using the NEA model and are very low, inferior to 0.5%, since in France, as in many other north-European countries, the peak demand occurs in the late afternoon at winter time. The capacity credit values obtained for France have also been used for the other European countries.

The NEA model computes the investment costs of new back-up capacity as that of the country-specific least-cost generating mix of dispatchable technologies, or as that of the cheapest technology available (either gas turbine or storage). More details on the adequacy cost calculations are reported in Appendix 4.C.

### Connection and transmission costs

Despite the fact that calculating connection cost for a given project is relatively straight-forward, there are few available data on a more aggregated level. Connection costs have been directly quantified for Germany and the United Kingdom in Bund (2011) and Ernst & Young (2009). The German Energy Agency has quantified at about EUR 10.9 billion the investment needed for connecting 8.5 GW of new offshore wind. This represents about 35% of the investment costs at the plant level. In the present report, however, a more conservative estimate from the Dena Study II of EUR 530/kW was adopted, i.e. about 15% of the investment costs (Dena, 2010). In the United Kingdom, the study from Ernst & Young estimates connection costs for offshore plants in a range of GBP 300-800/kW, depending on the distance from the shore; the present study adopts an intermediate value of GBP 500/kW, which corresponds to about 20% of the investment costs at the plant level. Connection costs for offshore have been estimated to lie between 10% and 25% of investment cost, depending on the distance from the shore (Green Net, 2009a). For the other countries, the average value of 17.5% was used. Regarding onshore wind, the Green report evaluates connection costs up to 5% of plant-level investment costs. Similar values are reported in the European Green Net study, where connection costs are estimated at 8% of plant-level cost for wind onshore and at 10-25% for wind offshore (Green Net, 2009a). Those last values have been taken as a reference for all the other countries in the study. No connection costs estimates are available neither for dispatchable power plants, nor for solar. For all those technologies, a value of 5% of the investment cost at the plant level has been used.

The US Department of Energy estimated that integrating 20% of wind production in the United States would require an investment of USD 23 billion in transmission, in comparison with an investment of 2 billion with only dispatchable technologies (DOE, 2008). The additional transmission costs for wind power are thus at around USD 53/kW. This value has been used in the study, at penetration levels of 10% and 30%. A more recent study from DOE (EWITS, 2011), quantifies transmission costs for a 30% wind penetration scenario and for three scenarios with 20% wind penetration. Transmission costs in the Eastern part of the United States are estimated at up to USD 150/kW in the 30% penetration scenario. Interestingly, according to the latter study, transmission costs in the United States tend to decrease with the penetration level of renewables, due to economies of scale and increasing proportion of high-voltage lines. The studies performed for European countries show a broad variation among countries. The large differences observed among different European studies are the expression of the difficulty of those calculations and the importance of different assumptions in the models. In general, however, transmission costs tend to raise with increased penetration levels of variable renewables. In the NEA model, no reinforcement costs are attributed to dispatchable technologies owing to the consideration that those power plants can be located in proximity to load centres.

## Results

Before discussing the results for grid-level system costs of the six OECD countries analysed in the present study, it is important to recall the difficulties and the limitations of such approach. Grid-level data are drawn from a large variety of reports which often focus on integration costs in a single country for a specific technology and penetration level. Results are not easy to compare, given the different data, methodology and assumptions used, the different level of detail proper to each analysis, as well as the different period in which the reports have been issued.<sup>18</sup> The large variations on costs estimates from different studies confirm the difficulties of any quantification of system costs and the large uncertainties associated. As an example, the first Dena Study I in 2005 quantified as EUR 31/kW the grid reinforcement and extension costs for wind integration, while the latest Dena Study II revised this value up to EUR 380/kW. This difference is only partially due to different penetration level assumed (10% vs. 30%). Finally, it should be noted that, due to the lack of data for the Republic of Korea, data from the United Kingdom for balancing and capacity credits were used to evaluate grid-level system costs.<sup>19</sup> Plant-level cost data as well as the structure of the electricity system are, of course, based on Korean data. Nevertheless, system costs derived for the Republic of Korea are valid only in a first approximation and should be viewed with caution.

However, despite those *caveats* and the intrinsic uncertainties affecting those estimates, some general trends can be clearly identified and a number of important conclusions can be drawn. First and most importantly, the system costs for integrating variable technologies into the electricity system are large: total grid-level costs lie in the range of USD 15-80/MWh, depending on the country and on the variable technology considered. Among renewable technologies, wind onshore has the lowest integration costs, while those of solar are generally the highest. Results also confirm that grid-level system cost may increase significantly with the penetration level of renewables. However any accurate assessment of these effects would require a specific in-depth study using similar assumptions and methodology. Grid-level system costs on a country-by country level are reported in Table 4.6 including their breakdown in different components.

The grid-level system costs of dispatchable technologies are at least one order of magnitude lower than those of renewables and, overall, add only few percentages to the total costs at the plant level. Among dispatchable technologies, nuclear has the highest grid-level costs, in the range of USD 1-3/MWh, mainly due to higher requirements for plant connection and additional balancing needs. Grid-level costs for coal and gas technologies are generally around USD 1 and USD 0.5/MWh, respectively.

18. In general grid-level costs have risen with time. This may be due to a better and broader understanding of the system effects of integrating renewable energy and on the associated costs.

19. As suggested by the Permanent Delegation of the Republic of Korea to the OECD.



Table 4.6: Grid-level system costs in selected OECD countries<sup>20</sup>

Finland												
Technology	Nuclear		Coal		Gas		Onshore wind		Offshore wind		Solar	
Penetration level	10%	30%	10%	30%	10%	30%	10%	30%	10%	30%	10%	30%
Back-up costs (adequacy)	0.00	0.00	0.06	0.06	0.00	0.00	8.05	9.70	9.68	10.67	21.40	22.04
Balancing costs	0.47	0.30	0.00	0.00	0.00	0.00	2.70	5.30	2.70	5.30	2.70	5.30
Grid connection	1.90	1.90	1.04	1.04	0.56	0.56	6.84	6.84	18.86	18.86	22.02	22.02
Grid reinforcement and extension	0.00	0.00	0.00	0.00	0.00	0.00	0.20	1.72	0.12	1.04	0.56	4.87
<b>Total grid-level system costs</b>	<b>2.37</b>	<b>2.20</b>	<b>1.10</b>	<b>1.10</b>	<b>0.56</b>	<b>0.56</b>	<b>17.79</b>	<b>23.56</b>	<b>31.36</b>	<b>35.87</b>	<b>46.67</b>	<b>54.22</b>

France												
Technology	Nuclear		Coal		Gas		Onshore wind		Offshore wind		Solar	
Penetration level	10%	30%	10%	30%	10%	30%	10%	30%	10%	30%	10%	30%
Back-up costs (adequacy)	0.00	0.00	0.08	0.08	0.00	0.00	8.14	8.67	8.14	8.67	19.40	19.81
Balancing costs	0.28	0.27	0.00	0.00	0.00	0.00	1.90	5.01	1.90	5.01	1.90	5.01
Grid connection	1.78	1.78	0.93	0.93	0.54	0.54	6.93	6.93	18.64	18.64	15.97	15.97
Grid reinforcement and extension	0.00	0.00	0.00	0.00	0.00	0.00	3.50	3.50	2.15	2.15	5.77	5.77
<b>Total grid-level system costs</b>	<b>2.07</b>	<b>2.05</b>	<b>1.01</b>	<b>1.01</b>	<b>0.54</b>	<b>0.54</b>	<b>20.47</b>	<b>24.10</b>	<b>30.83</b>	<b>34.47</b>	<b>43.03</b>	<b>46.55</b>

Germany												
Technology	Nuclear		Coal		Gas		Onshore wind		Offshore wind		Solar	
Penetration level	10%	30%	10%	30%	10%	30%	10%	30%	10%	30%	10%	30%
Back-up costs (adequacy)	0.00	0.00	0.04	0.04	0.00	0.00	7.96	8.84	7.96	8.84	19.22	19.71
Balancing costs	0.52	0.35	0.00	0.00	0.00	0.00	3.30	6.41	3.30	6.41	3.30	6.41
Grid connection	1.90	1.90	0.93	0.93	0.54	0.54	6.37	6.37	15.71	15.71	9.44	9.44
Grid reinforcement and extension	0.00	0.00	0.00	0.00	0.00	0.00	1.73	22.23	0.92	11.89	3.69	47.40
<b>Total grid-level system costs</b>	<b>2.42</b>	<b>2.25</b>	<b>0.97</b>	<b>0.97</b>	<b>0.54</b>	<b>0.54</b>	<b>19.36</b>	<b>43.85</b>	<b>27.90</b>	<b>42.85</b>	<b>35.64</b>	<b>82.95</b>

Republic of Korea												
Technology	Nuclear		Coal		Gas		Onshore wind		Offshore wind		Solar	
Penetration level	10%	30%	10%	30%	10%	30%	10%	30%	10%	30%	10%	30%
Back-up costs (adequacy)	0.00	0.00	0.03	0.03	0.00	0.00	2.36	4.04	2.36	4.04	9.21	9.40
Balancing costs	0.88	0.53	0.00	0.00	0.00	0.00	7.63	14.15	7.63	14.15	7.63	14.15
Grid connection	0.87	0.87	0.44	0.44	0.34	0.34	6.84	6.84	23.85	23.85	9.24	9.24
Grid reinforcement and extension	0.00	0.00	0.00	0.00	0.00	0.00	2.81	2.81	2.15	2.15	5.33	5.33
<b>Total grid-level system costs</b>	<b>1.74</b>	<b>1.40</b>	<b>0.46</b>	<b>0.46</b>	<b>0.34</b>	<b>0.34</b>	<b>19.64</b>	<b>27.84</b>	<b>35.99</b>	<b>44.19</b>	<b>31.42</b>	<b>38.12</b>

20. In particular back-up costs depend on capacity credit, load factors and assumed investment cost of dispatchable technologies. This could explain sometimes large differences in back-up costs even between comparable countries.

United Kingdom												
Technology	Nuclear		Coal		Gas		Onshore wind		Offshore wind		Solar	
	10%	30%	10%	30%	10%	30%	10%	30%	10%	30%	10%	30%
Back-up costs (adequacy)	0.00	0.00	0.06	0.06	0.00	0.00	4.05	6.92	4.05	6.92	26.08	26.82
Balancing costs	0.88	0.53	0.00	0.00	0.00	0.00	7.63	14.15	7.63	14.15	7.63	14.15
Grid connection	2.23	2.23	1.27	1.27	0.56	0.56	3.96	3.96	19.81	19.81	15.55	15.55
Grid reinforcement and extension	0.00	0.00	0.00	0.00	0.00	0.00	2.95	5.20	2.57	4.52	8.62	15.18
<b>Total grid-level system costs</b>	<b>3.10</b>	<b>2.76</b>	<b>1.34</b>	<b>1.34</b>	<b>0.56</b>	<b>0.56</b>	<b>18.60</b>	<b>30.23</b>	<b>34.05</b>	<b>45.39</b>	<b>57.89</b>	<b>71.71</b>

United States												
Technology	Nuclear		Coal		Gas		Onshore wind		Offshore wind		Solar	
	10%	30%	10%	30%	10%	30%	10%	30%	10%	30%	10%	30%
Back-up costs (adequacy)	0.00	0.00	0.04	0.04	0.00	0.00	5.61	6.14	2.10	6.85	0.00	10.45
Balancing costs	0.16	0.10	0.00	0.00	0.00	0.00	2.00	5.00	2.00	5.00	2.00	5.00
Grid connection	1.56	1.56	1.03	1.03	0.51	0.51	6.50	6.50	15.24	15.24	10.05	10.05
Grid reinforcement and extension	0.00	0.00	0.00	0.00	0.00	0.00	2.20	2.20	1.18	1.18	2.77	2.77
<b>Total grid-level system costs</b>	<b>1.72</b>	<b>1.67</b>	<b>1.07</b>	<b>1.07</b>	<b>0.51</b>	<b>0.51</b>	<b>16.30</b>	<b>19.84</b>	<b>20.51</b>	<b>28.26</b>	<b>14.82</b>	<b>28.27</b>

Figure 4.9: Plant- and grid-level costs for different technologies in the United Kingdom

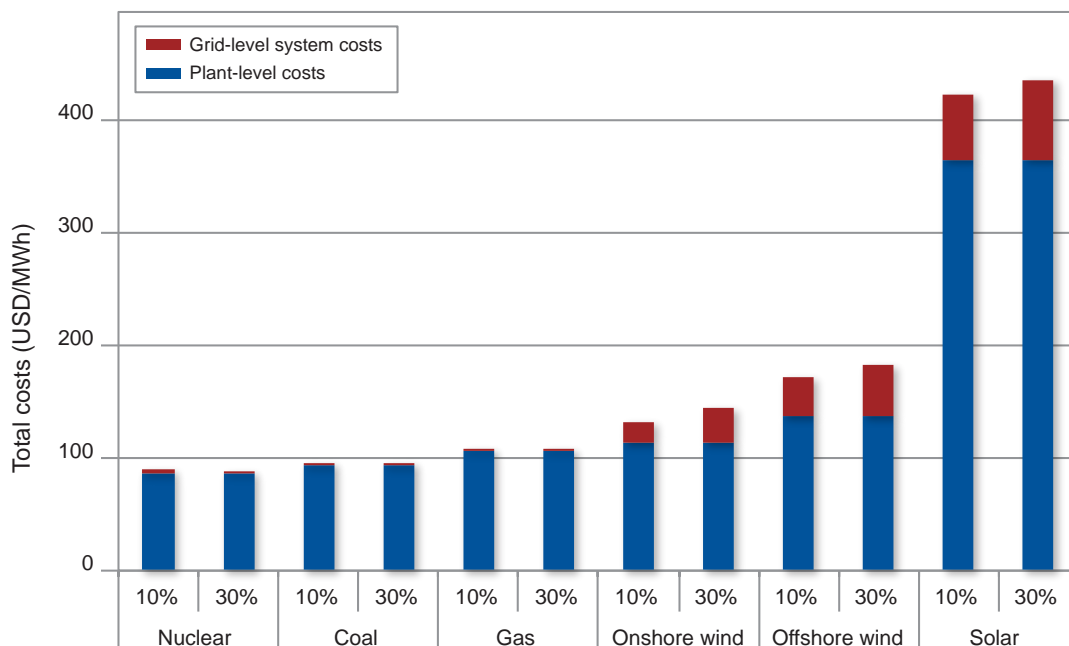

A direct comparison with the total costs (which include plant-level and grid-level system costs) of a dispatchable technology can help to visualise the full extent of grid integration costs for variable renewables. In Europe, grid-level costs for wind onshore represent about 20-65% of the total electricity generation cost for dispatchable technologies, while even higher values are observed for solar and wind offshore; on average, grid-level integration costs for renewables account for about 50% of the total electricity production cost.<sup>21</sup> As an illustration of the relation between plant-level and grid-level system costs, Figure 4.9 shows the total costs for the six technologies in the United Kingdom.

### **The total costs of electricity supply for different production levels of variable renewables**

The analysis performed in the previous section has the merit of clearly identifying the direct costs of building and operating a new generation source (plant-level costs) as well as their grid-level system costs. This analysis, however, does not fully account for other important aspects associated with the introduction of the new technology into the electricity system. Unaccounted for benefits at the system level of a power technology include the fuel and other variable cost savings arising from a reduced use of dispatchable technologies as well as the capital and other fixed cost savings from the dispatchable plants that would be effectively displaced.<sup>22</sup>

In the following analysis, an additional step is made towards the estimate of the total costs of the electricity supply at the macro-level by including:

- plant-level costs;
- system costs at the grid-level; and
- variable and fixed cost savings or increases due to the displacement of electricity production from conventional plants.

*De facto*, this results in a comparison of the total costs of two scenarios for a country's electricity supply – one with variable renewables and one without.

The methodology described below has been applied to the three major variable technologies: wind onshore, wind offshore and solar, in all six OECD countries considered. The reference system is a mix of conventional dispatchable technology such as gas (CCGT), coal and nuclear based on the respective shares in the national energy mix. The “new” electricity system is constituted by variable renewable sources, at 10% or 30% penetration level, while the residual electrical load is covered by dispatchable technologies. For the first approximation, the mix of dispatchable generators was taken as the same as that in the reference scenario. A quantitative estimation of the changes in the generation mix due to the introduction of renewables is provided in Appendix 4.D. For each country, the total cost of electricity supply (on an annual base) for satisfying the domestic electrical demand was calculated with the reference conventional mix and the additional annual costs were estimated for each scenario with renewable sources. The resulting average annual costs of electricity supply are provided in Figure 4.10 for a penetration level of renewables of 10% (results at 30% penetration level are provided in Figure 4.11). Table 4.7 shows the total costs and the cost increase of the system with renewables with respect to the reference system in USD/MWh.

System costs at a grid level to integrate renewable energy are large, especially at high penetration level, and contribute to a sizeable increase of the cost of electricity. At 30% penetration, renewables' grid-level costs alone increase the unit electricity cost by 11%, on average, for wind onshore, by 13% for wind offshore and by 17% for solar technology. At lower penetration levels, the impact on the unit electricity cost is reduced, by about a factor of four.

21. In the United States, average integration costs for variable renewable sum to 34% of the total costs of producing energy with nuclear power plants.

22. Unaccounted for additional costs include different elements such as loss of fuel efficiency and additional wear and tear for the dispatchable plants subject to more frequent load variations, energy losses in case of curtailment of renewable power when the offer exceeds the demand, and, more generally, an increase of more expensive dispatchable plants to cover the residual load.

**Figure 4.10: Average annual cost of electricity supply – 10% penetration level**

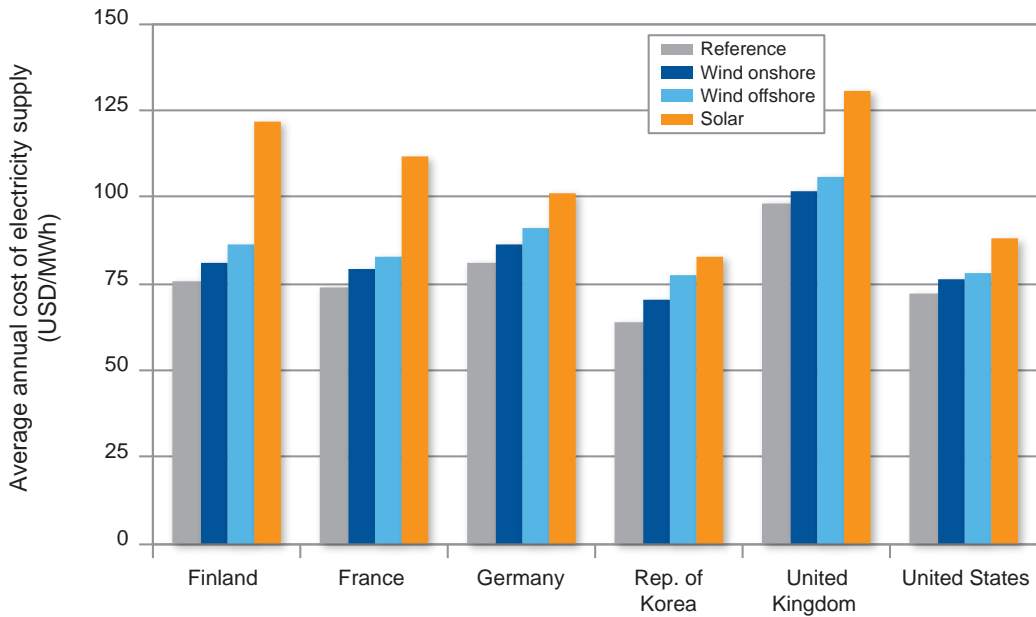

**Figure 4.11: Average annual cost of electricity supply – 30% penetration level**

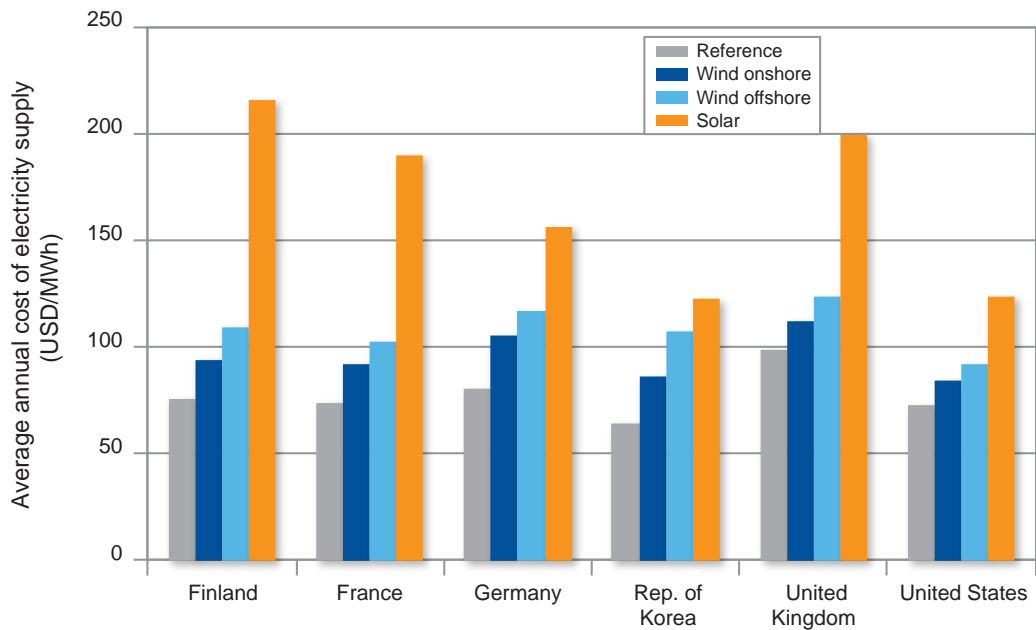

Grid-level system costs, however, represent only part of the electricity production cost increase. Currently, plant-level generation costs of renewables are also still significantly higher than those of conventional technologies and their integration in the generating mix would thus cause a further increase of electricity production costs. On average, the total costs of electricity production would increase for wind on- and offshore technology by 30% to 50% at a 30% penetration rate and by 8 to 15% at a 10% penetration rate. Depending on a country's size, this means that billions of USD need to be added to the annual costs of electricity systems which are borne by society as a whole. Covering 30% of the electricity supply of the United States with offshore wind would thus cost an astonishing additional outlay of USD 86 billion per year. Table 4.7 reports the total cost of electricity supply on a USD/MWh basis for all scenarios analysed. Two additional tables in Appendix 4.B report the cost increase per unit of renewable production and the total cost of electricity supply, on an absolute basis (Tables 4.1B and 4.2B respectively).

**Table 4.7: Total cost of electricity supply at different penetration levels of renewable energy\***  
(USD/MWh)

Total cost of electricity supply (USD/MWh)								
		Reference	10% penetration level			30% penetration level		
		Conv. mix	Wind onshore	Wind offshore	Solar	Wind onshore	Wind offshore	Solar
Finland	Total cost of electricity supply	75.9	81.2	86.5	121.8	93.5	109.0	215.9
	Increase in plant-level cost	-	3.5	8.2	41.2	10.5	24.7	123.7
	Grid-level system costs	-	1.8	2.3	4.7	7.1	8.3	16.3
	<b>Cost increase</b>	-	<b>5.3</b>	<b>10.6</b>	<b>45.9</b>	<b>17.6</b>	<b>33.1</b>	<b>140.0</b>
France	Total cost of electricity supply	73.7	79.5	82.9	112.0	92.1	102.5	189.6
	Increase in plant-level cost	-	3.7	6.9	34.0	11.1	20.8	101.9
	Grid-level system costs	-	2.0	2.3	4.3	7.2	7.9	14.0
	<b>Cost increase</b>	-	<b>5.8</b>	<b>9.2</b>	<b>38.3</b>	<b>18.3</b>	<b>28.8</b>	<b>115.9</b>
Germany	Total cost of electricity supply	80.7	86.6	91.3	101.2	105.5	116.9	156.2
	Increase in plant-level cost	-	3.9	7.8	16.9	11.6	23.3	50.6
	Grid-level system costs	-	1.9	2.8	3.6	13.2	12.9	24.9
	<b>Cost increase</b>	-	<b>5.8</b>	<b>10.6</b>	<b>20.4</b>	<b>24.8</b>	<b>36.2</b>	<b>75.4</b>
Rep. of Korea	Total cost of electricity supply	63.8	70.5	77.4	82.8	86.3	107.1	122.8
	Increase in plant-level cost	-	4.7	11.0	15.8	14.1	33.1	47.5
	Grid-level system costs	-	2.0	2.6	3.1	8.4	10.2	11.4
	<b>Cost increase</b>	-	<b>6.7</b>	<b>13.6</b>	<b>19.0</b>	<b>22.5</b>	<b>43.3</b>	<b>59.0</b>
United Kingdom	Total cost of electricity supply	98.3	101.7	105.6	130.6	111.9	123.6	199.4
	Increase in plant-level cost	-	1.5	3.9	26.5	4.5	11.7	79.6
	Grid-level system costs	-	1.9	3.4	5.8	9.1	13.6	21.5
	<b>Cost increase</b>	-	<b>3.4</b>	<b>7.3</b>	<b>32.3</b>	<b>13.6</b>	<b>25.3</b>	<b>101.1</b>
United States	Total cost of electricity supply	72.4	76.1	78.0	88.2	84.6	91.5	123.7
	Increase in plant-level cost	-	2.1	4.2	14.3	6.2	12.5	42.8
	Grid-level system costs	-	1.6	1.4	1.5	6.0	6.5	8.5
	<b>Cost increase</b>	-	<b>3.7</b>	<b>5.6</b>	<b>15.7</b>	<b>12.2</b>	<b>19.1</b>	<b>51.2</b>

\* Note that the grid-level costs expressed in this table are normalised to the electricity generated in the whole system while in Table 4.6 the grid-level system costs are normalised to the electricity produced by the specific technology in question.

### 4.3 De-optimisation of the generation mix and pecuniary externalities

The analysis performed in Section 4.2 is essentially a static analysis of technical externalities assuming a stable electricity mix. However, introducing large shares of renewable energy with low variable cost has also significant impacts on the optimal structure of the electricity generating mix, on resulting electricity prices and on the profitability of existing dispatchable power plants, which make up the pecuniary externalities referred to in Chapter 1. If the demand for electricity is stable or only moderately growing, as observed in most of the OECD countries in the last years, a large infeed of low variable cost electricity from renewable sources will reduce the market share and load factor of existing dispatchable power plants. However, the effects vary considerably among technologies, depending on the fixed vs. variable cost ratio, and on the time frame considered.

In the short term, electricity supply is quite inelastic. The generating structure of conventional power plants cannot therefore quickly adapt to the market changes induced by the introduction of renewable energy. All existing technologies experience a reduction of load factors. This reduction is relatively more significant for peak- and medium-load technologies than for baseload power plants since they are penalised by their high variable costs, which will push them out of the merit order. Finally, both electricity prices and CO<sub>2</sub> emissions decrease in the short term, due to the integration of a low marginal cost, low-carbon emitting technology, such as wind or solar.

In the long run, when new investment must be considered, reduced load factors mean that investors turn away from capital intensive baseload technologies such as nuclear. In the long run, variable renewables are low marginal cost technologies which will essentially substitute baseload plants, reducing their share in the optimal generation mix as well as their average load factors. On the contrary, the capacity of peak and medium load plants tends to increase in the optimal generating mix as they can cope somewhat better with reduced load factors. The study shows that the integration of renewable energy does not significantly affect the long-term market price of electricity and does not always reduce CO<sub>2</sub> emissions from the electricity sector. The latter effect is due to the shift from low-carbon nuclear to high-carbon peak-load technologies such as oil- or gas-fired turbines.

Adding low variable cost electricity from renewable technologies creates a new residual load curve for the dispatchable technologies. This is due to the fact that, without changes in demand, the electricity produced by renewables substitutes and displaces dispatchable power plants that have higher marginal costs. However, an important effect is that, due to the variability of wind and solar output, the shift of the residual load curve is more pronounced during periods of low demand than during periods of high demand.<sup>23</sup> The most important consequence for the electricity system is that, while the peak load is only moderately reduced, the minimal load decreases markedly with the increase of renewable penetration and, at higher penetration levels, there are extended periods in which the electricity produced by renewables exceeds the demand. As an example, at a 30% penetration rate, solar energy covers the full electricity load for more than 800 hours a year, i.e. for roughly 10% of the time. Overall, the system with renewables is more difficult and expensive to manage. Significant storage capacity, interconnections with neighbouring countries, load curtailment of renewables and significant load following from existing dispatchable capacity would be necessary to allow the integration of such large shares of variable renewable production.

A simple and intuitive way to describe the long-term and short-term changes in the electrical generation mix is based on the analysis of the annual duration and the residual load curves. They allow the straightforward determination of the optimal mix of dispatchable generators that would satisfy a given electricity demand at the lowest possible cost (see more detailed explanation in Box 4.4). The optimal generation mix can be computed for the reference case, without renewable energy, and for a number of different scenarios characterised by different penetration levels and combinations of variable renewables. This provides a good illustration of the changes in the optimal electricity mix induced by the introduction of variable renewables as well as the impact on the load factors, production rates and profitability of dispatchable technologies, in both in the short term and the long term. Finally, it is also possible to derive, at least as a first approximation, a quantitative evaluation of those effects.

23. This interesting and important effect can be seen by comparing residual duration curves at different penetration level of renewables. Figure 4.3C provides a clear illustration of those trends. Also a quantification of this system cost is provided in Appendix 4.C.

**Box 4.4****Calculating the optimal generation mix with residual load curves**

The method presented in Figure 4.12 below is commonly used in electricity market analysis. Based on fixed and variable production costs of various dispatchable generating technologies, it allows determination of the optimal generation mix that would satisfy a given demand at the lowest total cost. Originally, this method was designed for dispatchable technologies, but could be extended also to variable generators and to technologies with a limited energy stored in reserves such as reservoir hydro or storage. The following explains how the introduction of variable renewables changes the optimal generation mix.

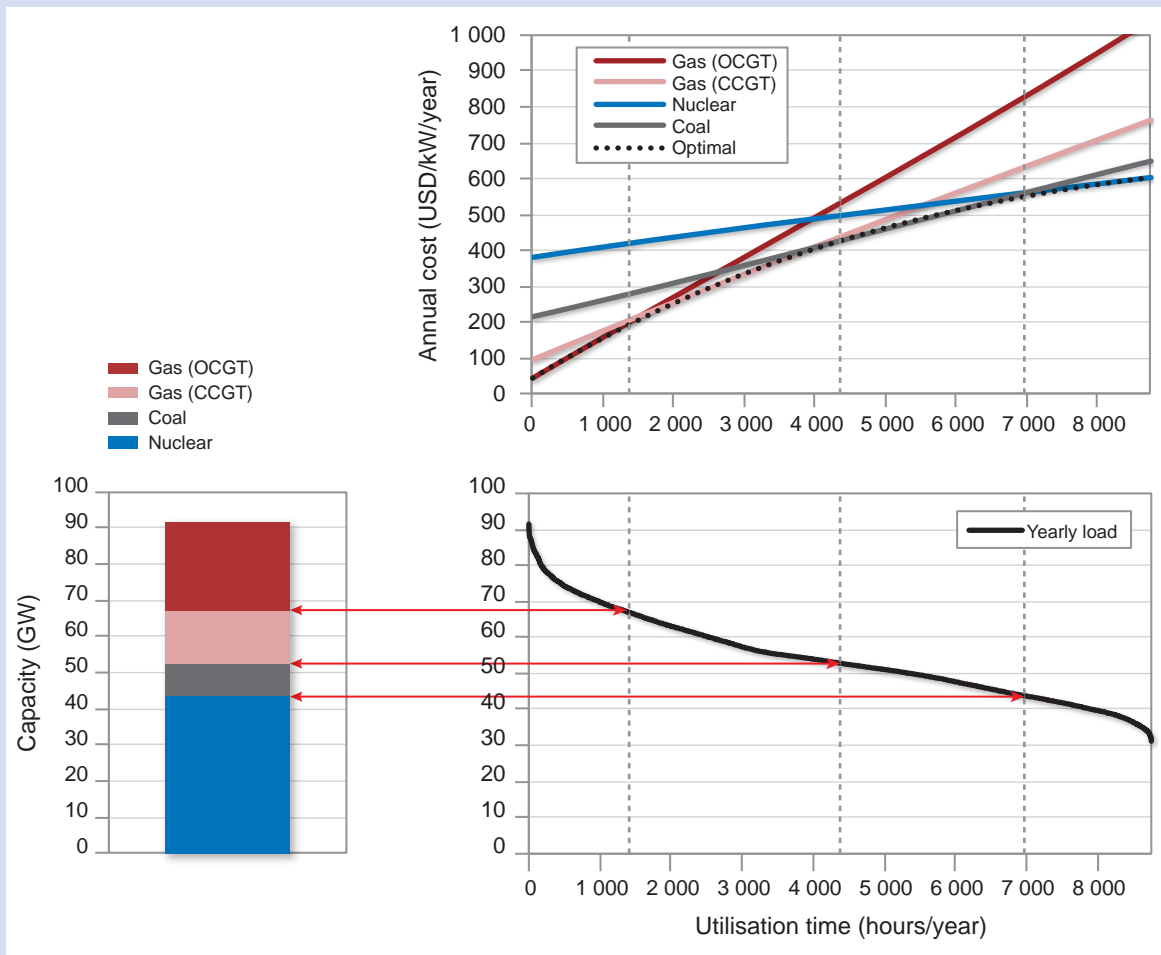
**Figure 4.12: Theoretical characterisation of the optimal generation mix**

Source: Jones, 2012.

The figure in the upper right corner shows the total cost curves for different dispatchable power plants, as a function of their utilisation time. Peak-load plants, represented by the red line, have low annualised fixed costs but have higher variable costs (O&M, fuel and CO<sub>2</sub> costs). Baseload plants, such as nuclear in the example, have high annualised fixed cost but low variable costs. The three dotted vertical grey lines indicate the utilisation time at which the different power plant types become efficient; at that load factor, the choice of one technology or the other does not make an economical difference. In the example presented, with the assumed carbon price of USD 30/tonne, a medium-load technology (coal) is the most efficient generator for an utilisation time between 4 380 and about 7 000 hours per year. If utilisation is higher than 7 000 hours nuclear is the most economical technology; for less than 4 380 CCGTs will be preferred. Open cycle gas turbines (OCGTs) are the optimal choice for utilisation times below 1 410 hours, while CCGTs are competitive between 1 410 and 4 380 hours.

Graphically, the optimal generation capacity of each technology is given by the intersection between the annual load curve and the vertical indifference lines<sup>24</sup> between technologies. The optimal generation mix is then reported in the figure at the bottom-left corner.

The example presented here includes four dispatchable technologies, nuclear, coal and gas (CCGT and OCGT), but could be generalised without difficulties to other dispatchable technologies. The method can be extended also to other variable low marginal cost generation technologies (wind, solar, not-storable hydro and any combination thereof). It is sufficient to replace the annual duration load curve by the residual load curve for dispatchable technologies after the infeed of electricity produced by low marginal cost technologies.

Reservoir-based hydro provides the electricity system with almost zero marginal cost electricity. However, due to the limits in the energy that can be stored, in most of the countries hydro is used to intervene only during peak times. Water is then pumped back into the reservoir at low demands periods to restore the potential energy available. Due to the complexity of effectively modelling reservoir-hydro, this technology has not been taken into account in our analysis. From a qualitative viewpoint, however, reservoir hydro is used in the left part of the load duration curve and thus reduces the peak load that must be met by dispatchable technologies. The overall effect is a reduction of the capacity of peak technology needed by the system.

Finally, it should be noted that the simple method used here does not consider electricity trading with neighbouring countries, nor storage or DSM. Interconnections and electricity trading help to smooth the load curve and ease the balancing challenge. Depending on the correlation degree between load curves, larger interconnected systems allow increasing the share of baseload technologies and reduce, sometimes significantly, the amount of peak load needed.

An additional aspect, however, is that the optimisation process outlined above does not take into account the differing abilities of technologies to provide system service and contribute to frequency and voltage stabilisation and the provision of reactive power, something that can only be provided by dispatchable technologies. Also the high ramps rates that the intermittency of variable renewables imposes on the system as a whole and which constitute real additional costs are not reflected in this analysis but must, of course, be taken into account in more complete power system planning.

The study presented in the following pages has been performed on the basis of the real electricity consumption and production data from the French electricity market in 2011. The economic and technical data used for deriving the technology specific annual costs are based on the values for OECD Europe reported in the most recent Projected Costs study (IEA/NEA, 2010). Four scenarios are analysed, for solar and wind production at two different levels of renewable penetration, 10% and 30%.<sup>25</sup> For simplicity, the model includes only four dispatchable power plant types, an OCGT, a CCGT, a coal and a nuclear power plant, and does not account for electricity exchanges with neighbouring countries. Nevertheless, the results appear robust to a wide range of different values.

### **The compression effect in the short run**

The introduction of large shares of low marginal cost renewable power, especially if not accompanied by an increase in electricity demand, has a significant impact on the utilisation profile of all existing power plants and on their average load factors. This is due to the fact that the advent of significant amounts of variable renewables implies that the original structure of the generation mix is no longer optimal. In the short term, the electricity system experiences some overcapacity, with a consequent reduction of electricity generated by existing dispatchable technologies. This increase in renewable capacity leads to a significant reduction in electricity prices, as observed in the German and Spanish electricity markets. The combination of reduced load factors and lower average electricity prices has a severe impact on the short-term profitability of existing power generation plants. This phenomenon, known as the compression effect, affects all existing power plants but is more significant for peak- and medium-load generators.

24. Lines showing the points where two technology choices would be equal as an economic basis.

25. A total installed capacity of 40 GW of solar and 26 GW of wind are required to generate 10% of the electricity consumed in France. The required capacities are multiplied by a factor of 3 for the 30% penetration scenario.



A graphical representation of the compression effect is shown in Figure 4.13, for a 30% wind penetration scenario. In absolute terms, wind substitutes mainly nuclear baseload and coal medium-load technologies.<sup>26</sup> The electrical load lost by nuclear and placed by renewables is given by the blue area; the grey, pink and red areas represent the load lost by coal and gas (both CCGT and OCGT), respectively. When expressed in relation to total output, the results show that the introduction of low marginal cost technology penalises peak- and medium-load power plants relatively stronger through a significant reduction of both their maximal utilisation time and their overall electricity production. In the scenario presented here, gas-fired plants experience an overall reduction of the electricity produced by about 80% (87% for OCGT and 71% for CCGT), while that for coal plants is about 60% relative to production without renewables. Comparatively, nuclear power is less affected in the short run, with a load reduction of less than 20%.

**Figure 4.13: Lost load for existing power plants after the introduction of wind power at 30% penetration level – short-term effect**

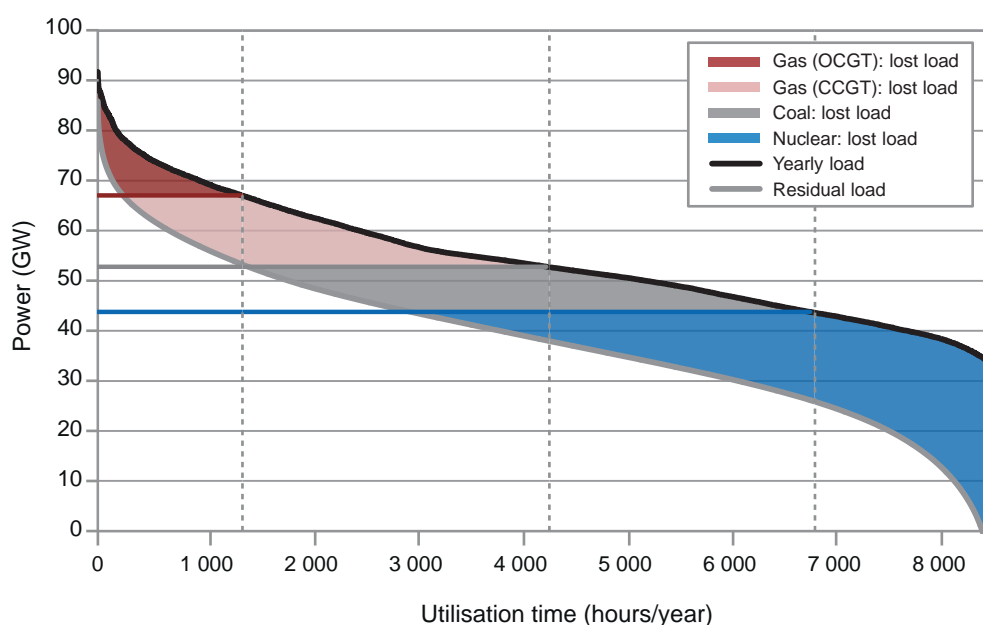

A second effect of the introduction of low marginal cost technologies is the reduction of the average electricity prices, at least on a short-term perspective. Due to the infeed of low marginal cost electricity, the supply curve shifts to the right, with a significant decrease of the number of hours in which peak- and medium-load technologies are marginal. This results in lower spot and average electricity prices and in a reduction of infra-marginal rent for base- and medium-load technologies.

The combination of the two factors described above, i.e. the reduction of the electricity produced by each plant and of infra-marginal rent, significantly undermines the profitability of existing power plants in the short term, even at relatively low penetration levels. The former effect affects mainly peak-load type of generators, while the latter is more relevant for base- and medium-load generators.

26. In the example shown, wind displaces about 74 TWh of nuclear production, 32 TWh of coal production and 35 TWh of gas production (OCGT and CCGT).

A quantitative evaluation of wholesale price variations in the short term and of the losses in load and profitability for existing power plants was prepared for the four scenarios described above. Electricity prices are modelled as reflecting the variable cost of the marginal technology plus a fixed mark-up of USD 10/MWh. The latter value is derived from the analysis of real market data for electricity in NEA (2011). Results obtained for the four scenarios are summarised in Table 4.8.

**Table 4.8: Electrical load and profitability losses in the short term relative to the scenario without renewables**

Penetration level		10%		30%	
Technology		Wind	Solar	Wind	Solar
Load losses	Gas turbine (OCGT)	-54%	-40%	-87%	-51%
	Gas turbine (CCGT)	-34%	-26%	-71%	-43%
	Coal	-27%	-28%	-62%	-44%
	Nuclear	-4%	-5%	-20%	-23%
Profitability losses	Gas turbine (OCGT)	-54%	-40%	-87%	-51%
	Gas turbine (CCGT)	-42%	-31%	-79%	-46%
	Coal	-35%	-30%	-69%	-46%
	Nuclear	-24%	-23%	-55%	-39%
Electricity price variation		-14%	-13%	-33%	-23%

Profitability of baseload technologies decreases significantly, even at low penetration levels of renewable energy. In comparison to the reference scenario without renewables, the profitability of nuclear power decreases by more than 20% at a 10% penetration rate and is more than halved at a 30% penetration rate. Medium- and peak-load power plants experience even more significant profitability reductions. Under such market conditions, existing power plants would be unable to recuperate their investment costs and, without additional incentives, it would be difficult to finance any new capacity, in particular for baseload power generation.

As expected, the infeed of low marginal cost electricity also reduces average electricity price on the spot market. A 13% decline in electricity prices is observed at a 10% renewable penetration level, while more significant reductions are observed at a 30% penetration levels, especially in the wind scenario.

### **Long-term effects on the optimal generating mix**

In the long run, i.e. when changes have been fully anticipated by the market, the introduction of low marginal cost technologies changes radically the structure of the optimal generation mix. In this context, electrical utilities have sufficient time to build new generation capacity and to adjust their production mix to the new residual load and the new market conditions. The addition of significant amount of renewable energy reduces the electrical capacity running at high load factors and increases the value of flexible production: a higher proportion of conventional stations is required to operate only at times when the production from renewables is below average. In those conditions, plants with relatively low capital costs will be favoured over those with low operating costs.

The long-term effect of the introduction of renewables on the optimal generation mix can be quantified and illustrated in a simple way using the methodology described in Box 4.4. First, the optimal generation mix of dispatchable technologies that satisfies at the lowest cost for a given electricity demand, represented by the annual load duration curve, is derived. The same methodology is then applied to the same electricity market after the integration of a given amount of renewable energy.

It is thus possible to directly quantify and compare the long-term effect of the introduction of a given amount of renewable energy in the generating mix. Two studies have been recently published using similar approaches for the German and British electricity markets (Nicolosi, 2010 and Green and Vasilakos, 2010). Their results confirm the present analysis. A graphical illustration of the methodology used in this study is given in Figure 4.14, using a load curve based on data provided by the French transport system operator (TSO), RTE.<sup>27</sup> The illustration in the lower part of the figure represents the base case with only dispatchable technologies (dark line) and the residual load where wind power supplies 30% of the total electricity needs (grey line). The figure at the bottom-left corner shows the optimal generation mix for the reference scenario without renewables as well as the scenario with variable renewable generation. The renewable installed generating capacity is given in the third vertical bar. In the middle column it is possible to visualise the capacity credit of renewable technology, i.e. the amount of dispatchable capacity that could be effectively replaced by renewables (the grey rectangle on top of the middle column).<sup>28</sup>

**Figure 4.14: Optimal dispatchable power mix with and without variable renewables**

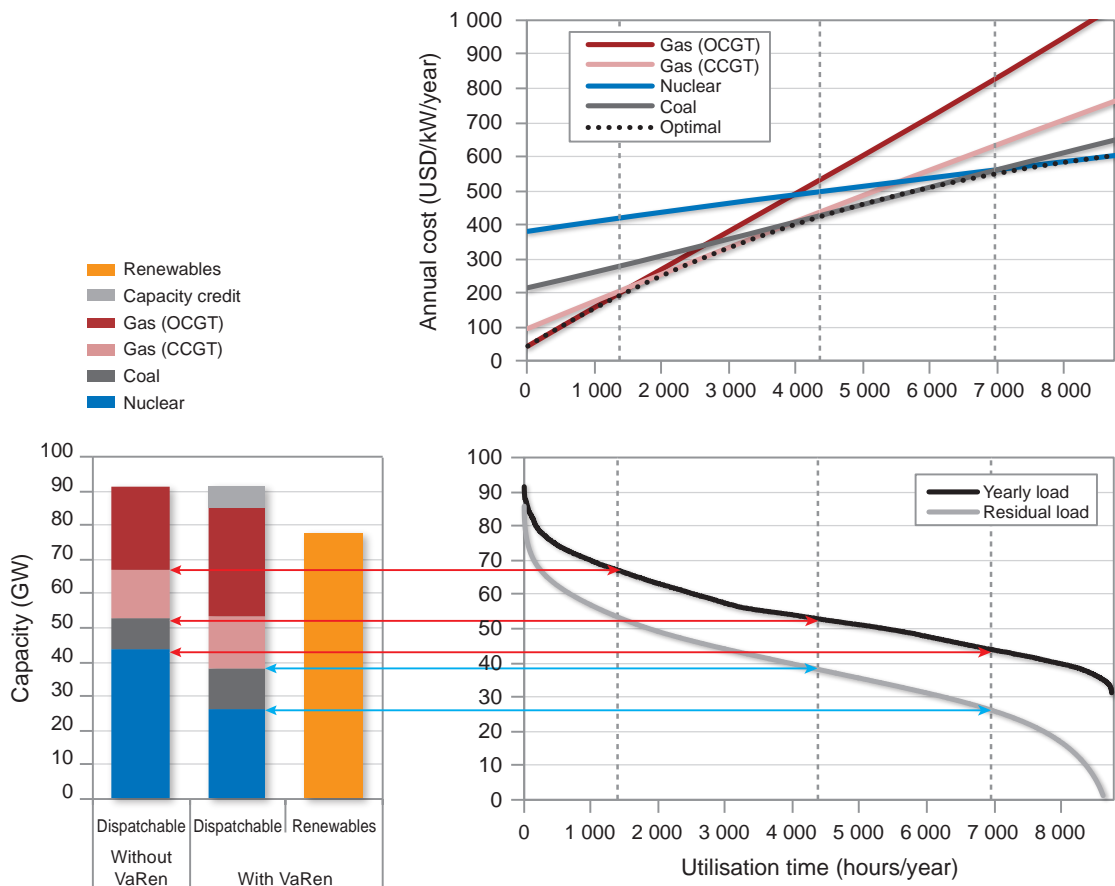

Note: “VaRen” means variable renewables.

27. While the exercise is based on a load curve constructed with the help of real French data, the example should not be construed as a precise rendering of the French electricity system. The current analysis does not include hydropower, exports and imports, or demand curtailment. The electricity systems of all OECD countries are also the result of historical circumstances, planning assumptions and government decisions that are not rendered in the present analysis, which is based on economic least-cost optimisation under perfect foresight with a restricted set of technologies.

28. A more accurate estimation of the capacity credit of variable technologies using residual duration curves is described in the appendices.

The composition of the optimal generation mix changes considerably in response to the introduction of variable renewable sources. The best conventional generation mix without renewables includes more baseload generators, nuclear in this case, which provides the large fraction of electricity needed at the lowest production cost. The introduction of renewable energy reduces significantly the capacity of baseload plants in the optimal generation mix. For a country with a load profile comparable with France, the optimal nuclear capacity in absence of renewables would amount to about 45 GW. In this context, the calculated optimal capacity, also indicated as “de-rated” capacity, assumes a load factor of 100% for all power plants. In order to take into account correctly the real load factor, it is simply needed to divide the “de-rated” optimal capacity calculated above by the load factor. For an assumed load factor of 80-80%, the real optimal capacity would be about 20% greater than that mentioned above, i.e. about 55 GW. In a scenario with 10% renewables, the optimal nuclear capacity would be about 38 GW of de-rated capacity, while in a 30% penetration scenario, the optimal nuclear capacity level would be in the 19-26 GW range. The optimal capacity structure for the reference case and for all four scenarios considered is showed in Figure 4.15.

A key aspect shown by this analysis is that variable renewables displace baseload capacity at more than a one-to-one basis.<sup>29</sup> This has significant effects on the structure of the generating mix and hence on the total costs to meet the residual load. This effect has been observed in all four scenarios analysed, and the effect becomes more and more significant with the renewable penetration level. For example, in the scenario represented in Figure 4.14 the introduction of 78 GW of wind power displaces, on the long run, about 19 GW of baseload nuclear capacity, i.e. about 40% of optimal capacity in the reference scenario. It is interesting to note that 78 GW of wind produces the same electricity as about 16.2 GW of dispatchable baseload. Baseload nuclear plants have *de facto* been replaced by both renewable energy as well as medium- and peak-load providers.

The effect of the integration of variable renewables on the optimal capacity of mid- and peak-load generators depends on the variability of the low marginal cost technology and on its correlation with the overall electricity demand. In all scenarios analysed, however, the introduction of renewable energy is accompanied by an increase of the capacity of both peak- and medium-load plants in the optimal generating mix. Those phenomena are more pronounced at higher penetration levels.

**Figure 4.15: Optimal generation mix in different scenarios**

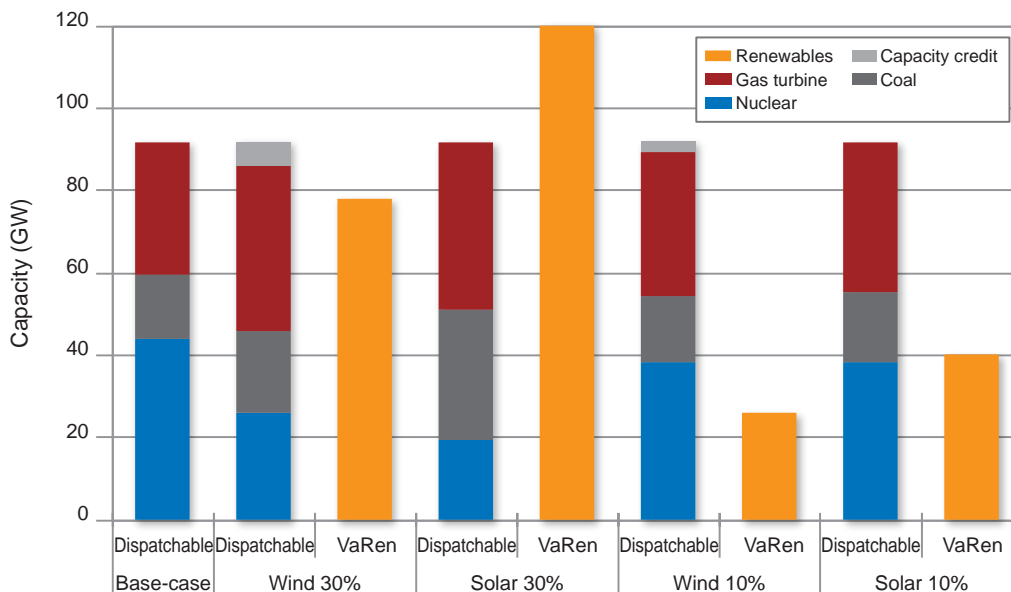

Note: “VaRen” means variable renewables.

29. For instance, the introduction of a low marginal cost technology would displace baseload technology exactly on a one-to-one basis.

If the introduction of low marginal cost electricity also strongly influences the behaviour of electricity market prices in the short term, the impact on long-term prices is negligible. Our analysis shows that the structure and the average level of electricity prices is identical in the scenario without renewables and in the two scenarios at 10% penetration level. On the contrary, at 30% penetration level there are limited periods in which renewables can meet all of demand and thus become the marginal generating technology, which in a competitive market means zero prices. The price duration curve in the renewable scenario is thus strictly the same as in the reference case, with the exception of those periods in which renewables become the marginal technology. However, the decrease in average electricity price observed in our study is very limited, less than 2% in the two scenarios considered.<sup>30</sup> The previously mentioned study of the United Kingdom electricity market (Green and Vasilakos, 2010) confirms those conclusions using a more complete model for electricity prices predictions.

### Impact on nuclear

In the long term, the introduction of low marginal cost variable generation affects mainly baseload technology, such as nuclear energy. The capacity and electricity produced by nuclear energy is considerably reduced in all four scenarios analysed: nuclear electricity production is almost halved at a 30% penetration level and is reduced by 13% at a 10% penetration level. This is the result of the combination of two effects: the decrease of the nuclear capacity in the optimal generating mix and a reduction of its load factor. Both aspects can be observed in Figure 4.16, which compares the residual load covered by nuclear after the introduction of wind energy (the dark blue area) with the original load without renewables (areas in light and dark blue). The figure also shows that the average load factor for nuclear decreases from 98% in the reference scenario to about 92%, after the integration of wind energy. This means that nuclear plants tend to be operated more frequently at a partial load and are required to cycle more often.

**Figure 4.16: Long-term evolution of optimal capacity and electricity production for baseload technology (wind scenario at 10% penetration level)**

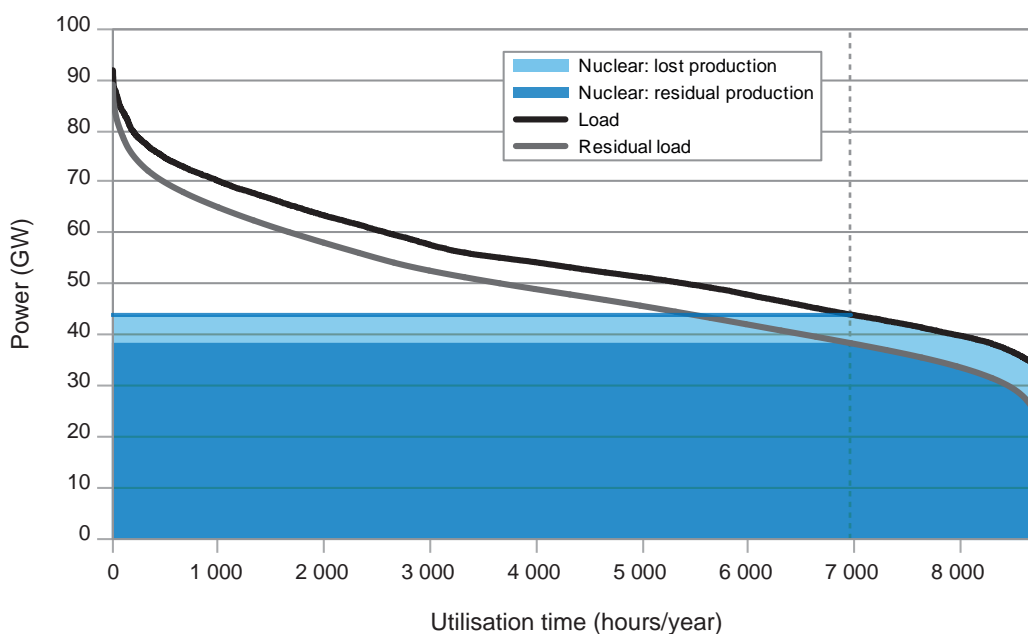

30. The decrease on average electricity prices is expected to be more significant at higher penetration level of renewables, as shown in the quantitative study presented in Chapter 7.

Contrary with what is observed in the short run, the profitability of dispatchable power plants, now at lower capacities, is not significantly affected by the introduction of renewable energy in the long term. This applies also to nuclear energy. The profitability of nuclear power plants is only marginally reduced, mainly because of the above-mentioned slight reduction of average load factors. As shown in the previous section, in the long term, the introduction of variable renewables does not change the structure of the electricity prices nor their average value. Overall, the profitability of nuclear power plants decreases by less than 0.5% for the two scenarios at a 10% penetration level and by less than 2.5% at a 30% penetration level.

Finally, it is interesting to assess the effect of a carbon price variation on the optimal structure of the generating mix, with particular emphasis on nuclear capacity. An increase in the carbon price would favour low-carbon sources such as renewables, nuclear and, to some extent, CCGTs over coal and OCGTs. Qualitatively, the indifference curve between nuclear and coal of Figure 4.14 would be shifted to the left, meaning that nuclear would substitute some coal capacity in the optimal mix. Also, CCGT would become more competitive than coal and OCGT, shifting the respective indifference curves to the left (CCGT/OCGT) and to the right (CCGT/coal). As a result higher carbon prices lead to more nuclear and CCGT capacity in the optimal generation mix at the expenses of coal and OCGT capacity. It is interesting to note that at CO<sub>2</sub> prices above USD 40 per tonne, coal would no longer be competitive and would thus exit the optimal energy mix. Figure 4.17 shows the optimal nuclear capacity for the reference scenario and two scenarios with wind, at 10% and 30% penetration levels respectively. Assumed carbon prices vary between 30 and 60 USD/tonne. At the 10% penetration level, a carbon price of 40 USD/tonne is sufficient to maintain nuclear capacity at 44 GW. However, at the 30% penetration level, the carbon price must reach at least 80 USD/tonne to ensure the same nuclear capacity in the optimal generation mix. For the wind scenario, the required carbon price level is 150 USD/tonne.

**Figure 4.17: Optimal nuclear capacity as a function of carbon price and renewable penetration level\***

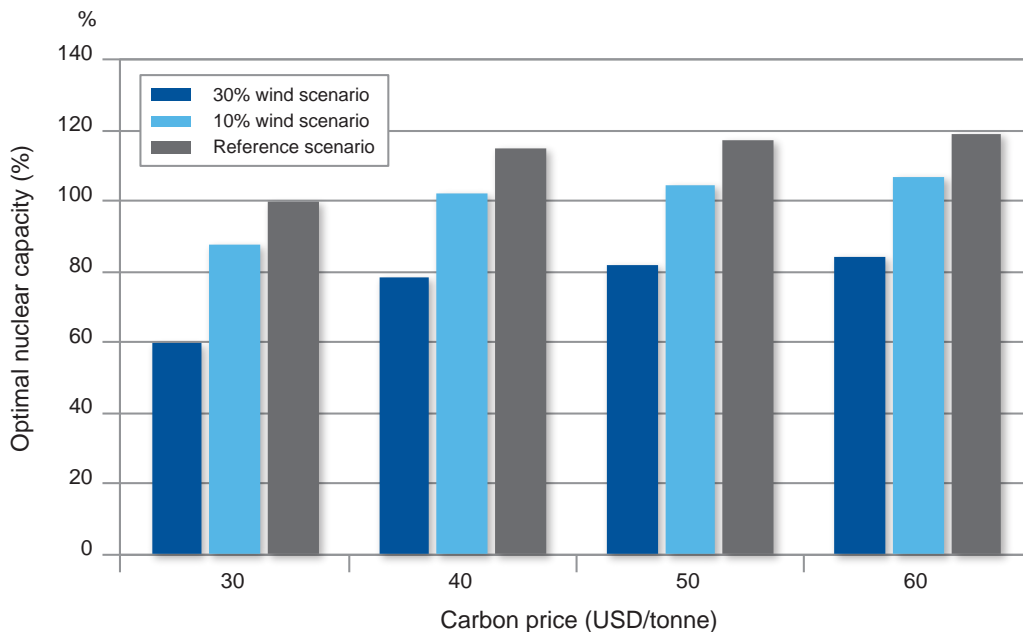

\* The optimal nuclear capacity in the different scenarios is expressed in percentage terms of the nuclear capacity in the reference scenario (i.e. without renewables).

### Impact on CO<sub>2</sub> emissions

Finally, it is interesting to consider the effect of the introduction of renewable energy on system-wide CO<sub>2</sub> emissions. In the short term, a significant fraction of the electricity produced by renewables effectively displaces carbon emitting sources, such as coal and gas and thus allows for large CO<sub>2</sub> emission reductions with respect to the reference scenario. Depending on the penetration level and the scenario considered, wind and solar technologies allows for a 30-60% reduction of CO<sub>2</sub> emissions in the short term. This reduction on carbon emissions, however, is not always confirmed in the long term.

As seen earlier, in the long term variable renewable energies lead to a reduction of baseload capacity and increases the amount of electricity produced by medium- and peak- load technologies. Introducing renewables into an electricity system whose baseload technology emits CO<sub>2</sub>, such as coal, will definitively reduce the CO<sub>2</sub> emissions from the electricity sector in both the short and the long term. However, this will not hold when the baseload technology displaced by renewables does not emit CO<sub>2</sub>, as is the case for nuclear energy. In this case instead, the electricity produced by fossil-fuelled technologies tends to increase, and CO<sub>2</sub> emissions will be generally higher than in the reference scenario without renewables. In other words, nuclear energy is more efficient than variable renewable energy in limiting CO<sub>2</sub> emissions as it will not induce a shift towards carbon-intensive peak-load technologies.

Overall carbon emissions have been evaluated for the five scenarios considered in this study, in both a short-term and a long-term perspective. In the reference scenario, the generation mix is composed by only four dispatchable technologies (OCGT, CCGT, coal and nuclear); the generation mix is optimised to satisfy the French annual electricity demand at minimal cost, without renewables and with a reference carbon price of 30 USD/tonne. In a second step, the total carbon emissions have been calculated after the introduction of wind and solar energy, at 10% and 30% penetration levels, both in the short term and in the long term.<sup>31</sup> Results are reported in Table 4.9.

As expected, carbon emissions drop significantly in the short term due to the displacement of fossil fuels by renewables. In the long term, however, the carbon emissions of the scenarios including renewables are higher than those of the reference case. If the carbon emissions do not vary significantly at low penetration levels, this is not the case at for the 30% penetration scenarios: the emissions increase by about 26% for wind and more than double for solar. Especially at large penetration rates, a low-carbon emitting technology (nuclear) is replaced not only by another low-carbon technology (solar or wind) but also by fossil fuels.

**Table 4.9: Short- and long-term CO<sub>2</sub> emissions**

	Reference (million tonnes of CO <sub>2</sub> )	10% penetration level		30% penetration level	
		Wind	Solar	Wind	Solar
Short-term	59.3	-31%	-29%	-66%	-44%
Long-term		2%	4%	26%	125%

In conclusion, a sensitivity study on the carbon emissions for different carbon price levels, up to 60 USD/tonne was performed. Results are reported on Table 4.10. At higher carbon price levels, low-carbon emitting technologies such as nuclear and CCGT displace less carbon efficient technologies, such as coal and OCGT; this contributes to reduce the overall emissions of carbon dioxide from the electricity sector. Comparatively, increasing CO<sub>2</sub> prices seems the most effective strategy to curb CO<sub>2</sub> emissions.

31. Again, this “ideal” generating mix, is far from the real generating mix for France, which includes a large fraction of hydropower that is not modelled here. Repeating the calculation for an energy mix that includes hydropower and takes into account the actual proportion of nuclear, coal and gas plants in the energy mix yields similar short-term reductions.

**Table 4.10: CO<sub>2</sub> emissions at different carbon price levels**

CO <sub>2</sub> price	Reference	10% penetration level		30% penetration level	
		Wind	Solar	Wind	Solar
30	<b>59.3</b>	2%	4%	26%	125%
35	-37%	-34%	-32%	-24%	1%
40	-62%	-60%	-56%	-55%	-49%
50	-65%	-64%	-60%	-59%	-54%
60	-68%	-67%	-63%	-63%	-58%

This concludes the analysis of the magnitude of the impacts of the introduction of variable renewables on grid-level system effects, the capacity and profitability of dispatchable technologies as well as carbon emissions both in the short and in the long run. Policy-makers and decision-makers would be well-advised to take note of the scale of the disruptions ahead. It should be pointed out that the shares of variable renewables that are underlying the present analysis are considerably below the ambitious long-term objectives that a number of OECD countries have set themselves in this respect.



## Appendix 4.A

# OECD system cost model

### Origin of the data

Assessment of system costs for a specific country requires a considerable amount of data, ranging from general data on the electricity market structure and the existing generation mix, to technology-by-technology estimates of electricity generation costs and to specific data on system costs at the grid level. This section reports the origin of the data used in the study as well as the assumptions and methods of calculation used. Data used in the system cost study are reported in the following three tables: Tables 4.1A and 4.2A contain the data on electricity markets and on generation costs for the six countries, which are the focus of the present study, while data on system costs at a grid level are reported in Table 4.3A.

All electricity market data used in the present study are taken from the latest *Electricity Information* published by the OECD International Energy Agency (IEA, 2011a).

**Table 4.1A: Country electricity data**

	Finland		France		Germany	
	Capacity (GW)	Production (TWh)	Capacity (GW)	Production (TWh)	Capacity (GW)	Production (TWh)
Nuclear	2.67	23.5	63.13	390.0	20.48	127.7
Coal	8.16	15.9	20.61	25.9	80.25	238.3
Gas		9.8		19.8		73.1
Oil		0.5		5.9		8.9
Hydro	3.12	12.7	25.32	61.2	10.64	24.3
Wind	0.15	0.3	4.43	7.9	25.78	38.6
Solar	0.01	0.0	0.27	0.2	9.80	6.6
Biofuels and waste	0.00	8.9	0.00	5.8	0.00	33.0
Geothermal	0.00	0.0	0.00	0.0	0.01	0.0

	Republic of Korea		United Kingdom		United States	
	Capacity (GW)	Production (TWh)	Capacity (GW)	Production (TWh)	Capacity (GW)	Production (TWh)
Nuclear	17.72	141.1	10.86	62.8	101.00	798.9
Coal	50.63	200.5	68.32	102.3	744.28	1 782.0
Gas		67.5		159.7		894.2
Oil		19.0		4.2		47.5
Hydro	5.52	4.7	4.39	8.9	100.68	296.3
Wind	0.35	0.7	4.42	9.3	34.30	73.9
Solar	0.42	0.6	0.03	0.0	2.09	2.4
Biofuels and waste	0.08	0.7	0.00	12.0	11.78	68.1
Geothermal	0.00	0.0	0.00	0.0	2.38	17.0

Source: IEA, 2011a.

Table 4.2A: Technology-by-technology data on electricity generating costs

		Plant data			Fixed costs	Variable costs	
		Net capacity (MW)	Electrical conversion (%)	Load factor (%)	Total overnight costs (USD/kW)	Fuel (USD/MWh)	O&M (USD/MWh)
Finland	Nuclear	1 400	33	85	4 101.5	9.3	14.7
	Coal	750	41	85	2 133.5	18.2	6.0
	Gas	480	57	85	1 069.0	61.2	4.5
	Wind onshore	45	100	26	2 348.6	0.0	21.9
	Wind offshore	300	100	43	4 893.0	0.0	46.3
	Solar	1	100	9	4 273.5	0.0	30.0
France	Nuclear	1 630	33	85	3 860.0	9.3	16.0
	Coal	800	46	85	1 904.0	28.2	12.7
	Gas	800	60	85	1 025.0	58.6	6.7
	Wind onshore	45	100	21	1 912.0	0.0	20.6
	Wind offshore	120	100	34	3 824.0	0.0	32.4
	Solar	10	100	13	4 273.5	0.0	81.0
Germany	Nuclear	1 600	33	85	4 102.0	9.3	8.8
	Coal	800	46	85	1 904.0	28.2	12.7
	Gas	800	60	85	1 025.0	58.6	6.7
	Wind onshore	3	100	23	1 934.0	0.0	36.6
	Wind offshore	300	100	43	4 893.0	0.0	46.3
	Solar	1	100	11	2 150.0	0.0	52.9
Republic of Korea	Nuclear	954	33	85	1 876.0	7.9	10.4
	Coal	767	41	85	895.0	31.5	4.3
	Gas	495	57	85	643.0	69.8	4.8
	Wind onshore	45	100	26	2 348.6	0.0	21.9
	Wind offshore	1	100	34	4 893.0	0.0	32.4
	Solar	1	100	14	2 673.0	0.0	30.0
United Kingdom	Nuclear	1 100	33	85	4 816.9	11.1	16.9
	Coal	1 600	44	85	2 611.9	30.7	10.9
	Gas	850	58	85	1 063.6	77.3	6.0
	Wind onshore	100	100	28	2 344.1	0.0	30.9
	Wind offshore	400	100	38	4 052.9	0.0	32.2
	Solar	1	100	10	3 150.0	0.0	39.9
United States	Nuclear	1 350	33	85	3 382.0	9.3	12.9
	Coal	600	39	85	2 108.0	19.6	8.8
	Gas	400	54	85	969.0	49.3	3.6
	Wind onshore	150	100	23	1 973.0	0.0	8.6
	Wind offshore	300	100	43	3 953.0	0.0	23.6
	Solar	5	100	18	3 877.5	0.0	5.7

Source: IEA/NEA, 2010.

The majority of individual plant data (net capacities, electrical conversion efficiency, load factors, fixed and variable costs) are derived from the latest version of the *Projected Costs of Generating Electricity*, a joint publication from the OECD International Energy Agency and Nuclear Energy Agency (IEA/NEA, 2010) also referred to as the Projected Costs study. A real discount rate of 7% has been assumed to compute fixed and variable costs. When not present in the Projected Costs database, data for a specific power plant type have been replaced by other data available in the Projected Costs study. For instance, data for coal and gas-fired power plants for France are derived from those from Germany. Also, the data for onshore and offshore wind technologies are not available for Finland and the Republic of Korea; values for wind onshore were replaced by the OECD median case and values for the wind offshore by those of Germany. For coherence with the analysis presented in Section 4.3, the load factors of wind onshore power plants in France have been obtained from the most recent data published by the French grid operator (RTE, 2011).

The Projected Costs study does not provide any data for the United Kingdom. For dispatchable power plants, data in Parsons (2011) have thus been used, taking an  $n^{\text{th}}$  of the kind plant and median case assumptions. Wind data are drawn from ARUP (2011) with median case assumptions.

Finally, the values reported in the Projected Costs study refer to the year 2008 and therefore do not take into account the recent decrease in price of PV modules. More up-to-date cost estimates and load factors for solar technology have been provided by the IEA Renewables Division. Germany and United Kingdom data are 2012 estimates from BSW (2012) and Parsons (2012), while data for France, the Republic of Korea and the United States are drawn from IEA publications of 2010 (IEA 2010a, 2010b and 2010c), with a 33% reduction in order to account for the afore-mentioned decrease in market prices. Solar investment cost for Finland are taken as those for France. Investment costs for solar PV are calculated as an average between utility and rooftop installation.

As mentioned, a variety of sources has been used to derive and report the system costs at the grid-level; the following list contains the main sources upon which this report is based.

- General data: ENTSO-E: *European Wind Integration Study* (EWIS, 2010).  
 OECD/IEA: *Design and Operation of Power Systems with Large Amounts of Wind* (Holtinen et al., 2009).  
 Green Net Europe: *Large Scale RES-E Integration in Europe* (Green Net, 2009a).  
 Green Net Europe: *Least Cost Grid Integration of RES in Europe* (Green Net, 2009b).
- France: RTE France: *Generation Adequacy Report in France – Edition 2011* (RTE, 2011).
- Germany: Deutsche Energie-Agentur: *Dena Study I* (Dena, 2005).  
 Deutsche Energie-Agentur: *Dena Study II* (Dena, 2010).
- United Kingdom: Department of Business: *Renewable Support Schemes* (Redpoint, 2008).  
 Department of Industry: *Quantifying the System Costs of Additional Renewable in 2020* (ILEX, 2002).
- United States: US Department of Energy: *20% Wind Energy by 2030* (DOE, 2008).  
 US Department of Energy: *Western Wind and Solar Integration Study* (DOE, 2010).  
 US Department of Energy: *Eastern Wind Integration and Transmission Study* (EWITS, 2011).

Concerning balancing costs, data for Finland have been taken from IEA (2011b). A recent study from ENTSO-E, the *European Wind Integration Study* (EWIS, 2010), has estimated for continental Europe a balancing cost of EUR 2.7/MWh, at a penetration level of 8-10% (base case scenario). An increase of wind penetration up to 20-26% will lead to a corresponding balancing cost increase of about EUR 2-2.6/MWh. These data have also been used for France. Data for Germany at 10% penetration level have been drawn from the Dena Study (Dena, 2005); the values at 30% penetration have been calculated applying the increase calculated by EWIS (2010). The source of data for the United Kingdom is Redpoint (2008). Several studies in the United States (for Minnesota, Colorado, New York, Pacific region) indicate a range of balancing cost between 0.5 and USD 5/MWh. The values used in our model lie in the same range and are taken from a recent and comprehensive integration study in the Eastern region of the United States (EWITS, 2011).

Table 4.3A: System cost data

		Capacity credit (%)		Balancing cost (USD/MWh)		Grid reinforcement (USD/kW)		Connection cost (fraction of inv. cost) (%)
		10%	30%	10%	30%	10%	30%	
Finland	Nuclear	97.0	97.0	0.5	0.3	0.0	0.0	5.0
	Coal	96.2	96.2	0.0	0.0	0.0	0.0	5.0
	Gas	97.0	97.0	0.0	0.0	0.0	0.0	5.0
	Wind onshore	10.0	6.0	2.7	5.3	5.4	47.3	8.0
	Wind offshore	10.0	6.0	2.7	5.3	5.4	47.3	17.5
	Solar	0.4	0.1	2.7	5.3	5.4	47.3	5.0
France	Nuclear	97.0	97.0	0.3	0.3	0.0	0.0	5.0
	Coal	96.2	96.2	0.0	0.0	0.0	0.0	5.0
	Gas	97.0	97.0	0.0	0.0	0.0	0.0	5.0
	Wind onshore	7.0	5.9	1.9	5.0	77.1	77.1	8.0
	Wind offshore	11.4	9.6	1.9	5.0	77.1	77.1	17.5
	Solar	0.4	0.1	1.9	5.0	77.1	77.1	5.0
Germany	Nuclear	97.0	97.0	0.5	0.3	0.0	0.0	5.0
	Coal	96.2	96.2	0.0	0.0	0.0	0.0	5.0
	Gas	97.0	97.0	0.0	0.0	0.0	0.0	5.0
	Wind onshore	8.0	6.0	3.3	6.4	42.0	540.0	8.0
	Wind offshore	15.0	11.2	3.3	6.4	42.0	540.0	14.6
	Solar	0.4	0.1	3.3	6.4	42.0	540.0	5.0
Republic of Korea	Nuclear	97.0	97.0	0.9	0.5	0.0	0.0	5.0
	Coal	96.2	96.2	0.0	0.0	0.0	0.0	5.0
	Gas	97.0	97.0	0.0	0.0	0.0	0.0	5.0
	Wind onshore	20.4	13.9	7.6	14.2	77.1	77.1	8.0
	Wind offshore	26.7	18.2	7.6	14.2	77.1	77.1	17.5
	Solar	0.4	0.1	7.6	14.2	77.1	77.1	5.0
United Kingdom	Nuclear	97.0	97.0	0.9	0.5	0.0	0.0	5.0
	Coal	96.2	96.2	0.0	0.0	0.0	0.0	5.0
	Gas	97.0	97.0	0.0	0.0	0.0	0.0	5.0
	Wind onshore	22.0	15.0	7.6	14.2	87.3	153.7	5.0
	Wind offshore	29.9	20.4	7.6	14.2	87.3	153.7	19.6
	Solar	0.4	0.1	7.6	14.2	87.3	153.7	5.0
United States	Nuclear	97.0	97.0	0.2	0.1	0.0	0.0	5.0
	Coal	96.2	96.2	0.0	0.0	0.0	0.0	5.0
	Gas	97.0	97.0	0.0	0.0	0.0	0.0	5.0
	Wind onshore	13.5	12.3	2.0	5.0	53.4	53.4	8.0
	Wind offshore	40.0	20.0	2.0	5.0	53.4	53.4	17.5
	Solar	27.3	10.9	2.0	5.0	53.4	53.4	5.0

Building new transmission lines or reinforcing existing lines benefit the whole electricity system and it is difficult to allocate their costs among different market participants. Most of the country studies, however, calculate grid reinforcements cost as the additional investments in the transmission grid after the integration of a given target of renewables with respect to those required for an “equivalent” system without renewables. As expected, the assumptions and methodology used for grid transmission optimisation, the degree of detail in the models used and the definition of an equivalent reference system without renewables have a large impact on resulting transmission costs.

Transmission costs for the United States have been taken from the 2008 DOE study, for a 20% wind penetration level. This value is used in both the 10% and the 30% scenario. Transmission costs for Finland have been derived from Holttinen *et al.* (2009), which estimates additional transmission costs of EUR 4 and EUR 35/kW, respectively at 5% and 20% wind penetration level. Those values have been used for the 10% and 30% scenarios, without adjustment. The values for France have been drawn from the Green Net study, which reports the findings from a study performed in 2003 (Verseille, 2003). According to this study, the French transmission grid could cope with 6 GW of wind power with only minor investments. However, if the capacity were increased up to 14 GW, additional investments of about EUR 800 million would be needed. This value, which corresponds to a wind penetration level of 7%, is used in our model for both scenarios without adjustment.

For the United Kingdom, the ILEX report quantifies at GBP 2.84/MWh, the additional transmission costs for a scenario with 27% of wind energy. The value of EUR 1.9/MWh, used in the 10% penetration scenario, has been obtained by interpolation from the values provided in Green Net (2009b) for a 20% and 30% penetration levels. Grid transmission costs for integrating wind energy in Germany have been estimated in the Dena Study I, for a penetration level of 10%, and in the Dena Study II, for a penetration level of 30% (Dena, 2005 and Dena, 2010). The large difference observed among those two evaluations, with transmission costs increasing from EUR 31 to 400/kW, may reflect also different assumptions taken in the studies. With the exception of Germany, there are no direct estimates of the grid transmission and reinforcement costs for the integration of solar energy. Thus, transmission costs for solar technology, when not available, have been taken as that for wind energy. The only data available are based on a study of the German Association of Energy and Water Industries; according to their estimates, transmission costs for solar energy would be approximately EUR 400/kW (Barth, 2011).

The capacity credit of dispatchable power plants has been calculated as one minus the unplanned outage rate, as in Holttinen *et al.* (2009). The assumed unplanned outage rate is 3% for nuclear and gas power plants and 3.8% for hard coal power plants. Those values, originally derived from the Dena Study I (Dena, 2005) have been adopted for all individual countries in this study. Capacity values for Finland, 10% and 6% at 10% and 30% penetration levels, respectively, have been suggested by Holttinen (private communication), based on Satka (2010). The values for wind onshore in Germany have been taken from IEA (2011b): the value at 10% penetration level was obtained by an extrapolation of the data from a 20% to 45% interval. The capacity values for France (wind onshore) have been obtained with the NEA methodology described in Appendix 4.C. The values for the United States are based on DOE (2010) and Holttinen *et al.* (2009) for wind onshore and wind offshore, respectively, while those for United Kingdom are based on the Redpoint (2008) report. Often the studies analysed do not differentiate between onshore and offshore technologies: the capacity values for wind offshore have therefore been adjusted from the values for wind onshore to take into account their different average load factors (as in France, Germany and the United Kingdom).

Finally, only a study from the United States calculates capacity credit for solar PV plants at low penetration rates of 1%, 3% and 5% (DOE, 2010); the high values reported (between 25% and 30%) are obtained for a location where the daily peak load occurs at 16.00. The data used in the model have been derived from Jones (2012), which calculates capacity credit for solar in California for different values of solar capacity installed. Resulting capacity credit is quite high, reflecting the favourable conditions in term of load factor and correlation with the demand in the South West of the United States. Solar capacity values for France have been obtained using an ad hoc model developed internally at the NEA. Capacity credit values for solar are very low, inferior to 0.5%. In France peak demand occurs in the late afternoon at winter time, when the solar output is negligible. Those values have been used for the other European countries, owing the consideration that peak demand occurs roughly during the same periods as in France.

## Calculation model

The model developed by the NEA for evaluating system costs is a natural extension of the one used in the IEA/NEA Projected Costs study (IEA/NEA, 2010). It relies on the same database and uses the same methodology for calculating the LCOE. In the present study, however, a single discount rate of 7% real was adopted, while the Projected Costs study was based on two different values, 5% and 10% respectively. The plant-level cost data have therefore been computed with the new 7% discount rate. In the spirit of the Projected Costs study, plant-level costs, grid-level system costs and total system costs are given in USD per unit of electricity produced (USD/MWh). In order to ensure consistency among cost data, the exchange rates used in the Projected Costs study were adopted. The assumed exchange rates are USD 1.30/EUR and USD 1.59/GBP.

Grid connection and grid reinforcement costs are the direct investment cost needed to build new transmission lines and are expressed in USD/kW or as a fraction of the investment costs at the plant level. Those investment costs are then divided by the total amount of electricity produced by a given plant during its lifetime, opportunely discounted.

The calculation of adequacy costs is more complex, and has been performed in the following steps. For a given country, a given technology and a given penetration level, the firm capacity guaranteed by that technology and the one guaranteed by the existing mix of dispatchable technologies that would provide the same electrical energy output were calculated. The difference between those values gives the amount of additional capacity that must be built in order to achieve the same adequacy level (in addition to the same electricity output) in the two systems. Once the additional generation capacity to be built is known, the investment costs for building this capacity are determined. The NEA model calculates the least-cost capacity mix that can compensate the intermittency of wind and solar power depending on their annual production profile. Given the lack of country-by-country data on wind and solar production, the French values were taken as a common reference for the least-cost shares. While this may seem a rather strong assumption, the general result of a mix of peak- and mid-load technologies is consistent with intuition. Nevertheless, further research would, of course, be needed once country-by-country production profiles for wind and solar power become available.

## Appendix 4.B

### Supplementary tables and data

The following two tables complement the results given in Section 4.2.

**Table 4.1B: Total cost increase per unit of renewable production above the reference case**

	Cost increase per unit of renewable production (USD/MWh)					
	10% penetration level			30% penetration level		
	Wind onshore	Wind offshore	Solar	Wind onshore	Wind offshore	Solar
Finland	52.8	105.8	459.0	58.6	110.3	466.6
France	57.5	92.3	382.7	61.1	96.0	386.2
Germany	58.1	105.6	204.2	82.6	120.5	251.5
Republic of Korea	66.8	136.2	189.9	75.0	144.4	196.6
United Kingdom	33.7	73.1	323.3	45.3	84.4	337.1
United States	37.1	55.8	157.3	40.6	63.6	170.8

**Table 4.2B: Increase in the total cost of electricity supply due to the integration of renewable energy (million USD)**

Total cost of electricity supply (million USD)								
		Reference	10% penetration level			30% penetration level		
		Conv. mix	Wind onshore	Wind offshore	Solar	Wind onshore	Wind offshore	Solar
Finland	Total cost of electricity supply	5 436	5 815	6 194	8 723	6 695	7 805	15 459
	Increase at the plant level		251	591	2 953	752	1 772	8 858
	Grid-level system cost		127	167	334	506	597	1 165
	<b>Increase in the total cost of electricity supply</b>		<b>378</b>	<b>757</b>	<b>3 287</b>	<b>1 258</b>	<b>2 369</b>	<b>10 022</b>
France	Total cost of electricity supply	38 118	41 092	42 892	57 907	47 603	53 005	98 031
	Increase at the plant level		1 915	3 593	17 564	5 746	10 780	52 692
	Grid-level system cost		1 059	1 181	2 225	3 739	4 108	7 221
	<b>Increase in the total cost of electricity supply</b>		<b>2 974</b>	<b>4 774</b>	<b>19 789</b>	<b>9 485</b>	<b>14 888</b>	<b>59 913</b>
Germany	Total cost of electricity supply	44 452	47 651	50 264	55 692	58 093	64 355	85 985
	Increase at the plant level		2 133	4 275	9 278	6 399	12 826	27 833
	Grid-level system cost		1 066	1 536	1 962	7 242	7 077	13 699
	<b>Increase in the total cost of electricity supply</b>		<b>3 199</b>	<b>5 811</b>	<b>11 240</b>	<b>13 641</b>	<b>19 903</b>	<b>41 533</b>
Rep. of Korea	Total cost of electricity supply	27 745	30 648	33 665	36 001	37 525	46 574	53 387
	Increase at the plant level		2 050	4 799	6 890	6 149	14 398	20 670
	Grid-level system cost		854	1 120	1 366	3 631	4 431	4 972
	<b>Increase in the total cost of electricity supply</b>		<b>2 904</b>	<b>5 920</b>	<b>8 256</b>	<b>9 781</b>	<b>18 829</b>	<b>25 642</b>
United Kingdom	Total cost of electricity supply	35 312	36 521	37 938	46 925	40 193	44 412	71 640
	Increase at the plant level		541	1 403	9 533	1 623	4 209	28 600
	Grid-level system cost		668	1 223	2 079	3 258	4 891	7 727
	<b>Increase in the total cost of electricity supply</b>		<b>1 209</b>	<b>2 626</b>	<b>11 613</b>	<b>4 881</b>	<b>9 100</b>	<b>36 327</b>
United States	Total cost of electricity supply	287 009	301 696	309 127	349 370	335 280	362 578	490 083
	Increase at the plant level		8 227	16 574	56 487	24 682	49 721	169 462
	Grid-level system cost		6 460	5 545	5 873	23 589	25 848	33 612
	<b>Increase in the total cost of electricity supply</b>		<b>14 687</b>	<b>22 118</b>	<b>62 361</b>	<b>48 271</b>	<b>75 569</b>	<b>203 074</b>



## Appendix 4.C

# Calculation of the optimal generation mix using annual LOAD duration curve and residual duration curves

The annual load duration curve gives a simple “snapshot” of the main characteristics of the electricity system at a country level. It shows the amount of time for which electricity demand exceeds a certain value. It is easily obtained by ordering hourly demand over a one-year period from highest to lowest demand. Combining the duration curve with data on fixed and variable costs of different generating technologies, it is possible to derive the optimal generation mix to satisfy a given electricity demand.

The introduction of variable renewables changes the electrical load that must be supplied by the rest of the electricity generating system (residual load curve). The residual load curve is obtained by subtracting the electricity produced by the low marginal cost technology from the electricity load. Once calculated the residual load curve for a given amount of renewable energy, it is then possible to derive the “new” optimal generation mix, which satisfies that specific load at the least-cost.

The annual load duration curve used in this study has been obtained from the electricity consumption data in France for the year 2011. The French grid operator RTE publishes on its Internet site the electricity consumption data for France with a time resolution of 30 minutes. Residual duration curves have been calculated for two variable generation technologies, wind and solar, and for a generic dispatchable technology. Two different penetration levels are considered: 10% and 30% of the annual electricity consumption. Residual load curves have been obtained with a Monte Carlo process taking into account the loads variability of wind and solar production. The annual duration curve and the residual curve for the four scenarios calculated are shown in Figure 4.3C.

Concerning wind energy, the probability density function of different levels of production is shown in Figure 4.1C based on the aggregated electricity production and load factors for all wind farms operating in France in 2011. These data have been supplied by the French transport grid operator RTE.<sup>32</sup> In 2011, the average load factor for wind production was about 21%. For each penetration level, a residual load duration curve is obtained with a Monte Carlo process taking into account the load factor distribution and the total wind capacity installed.

Concerning solar technology, RTE does not provide real production data for France. The seasonal and daily distribution in the solar output is modelled using the insolation database provided by the European Joint Research Centre of Ispra<sup>33</sup> and has been scaled to obtain the average annual load factor assumed for solar technology in France (13%). The corresponding average hourly load factor is shown by the dark blue line in Figure 4.2C. In order to take into account the statistical variation of solar production, it was assumed that load factors can vary within a 50-150% range, with a uniform probability. For example, in the moment of maximal radiance, at mid-day in August, the average solar production in the country may vary within 26% and 78% of the total capacity installed. The load factor range is indicated in Figure 4.2C by the light blue area. This methodology allows to take into account the correlation between solar output and electricity demand.

With these assumptions in place, it was possible to compute the residual load duration curves presented in Figure 4.3C.

32. RTE makes available on its Internet site the hourly wind production forecasts, made one hour before production. The analysis is based on the load factors for wind for the period from 15/01/2011 to 31/01/2012.

33. The data used in the model refer to a location in the South of France and have a 20 minutes resolution. More information can be found at the following address: <http://re.jrc.ec.europa.eu/pvgis/apps3/pvest.php>.

**Figure 4.1C: Load factor probability distribution for wind**

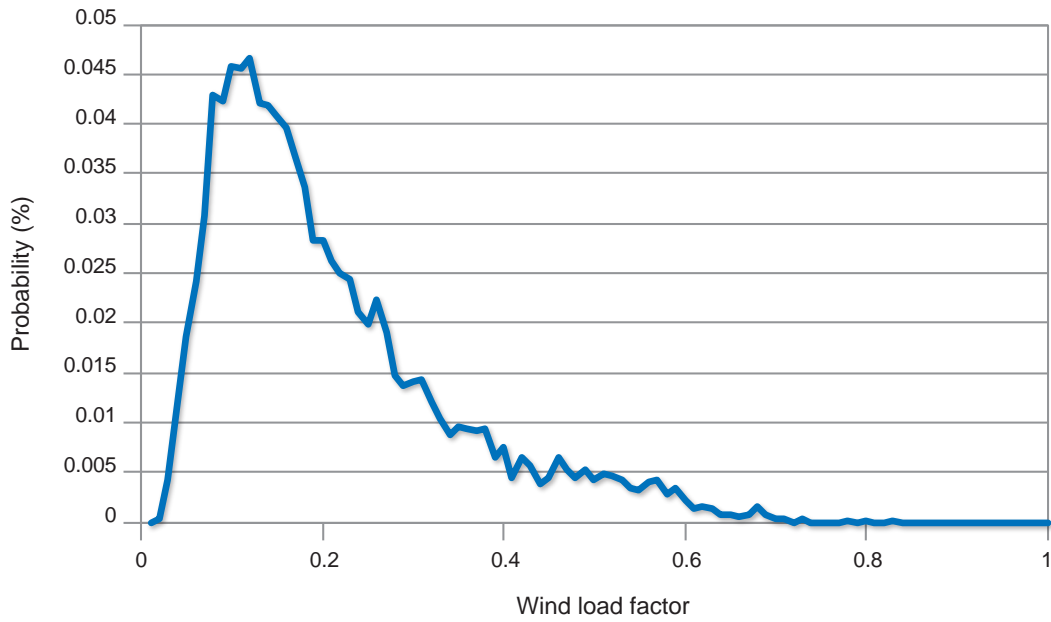

**Figure 4.2C: Assumed load factor variability for solar**

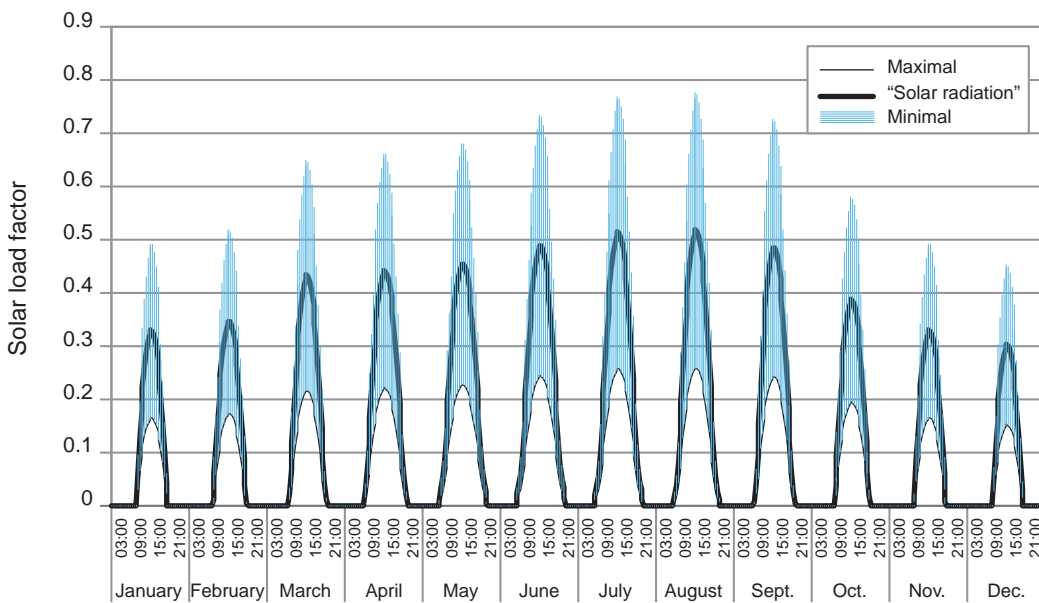

Figure 4.3C: Residual duration curves

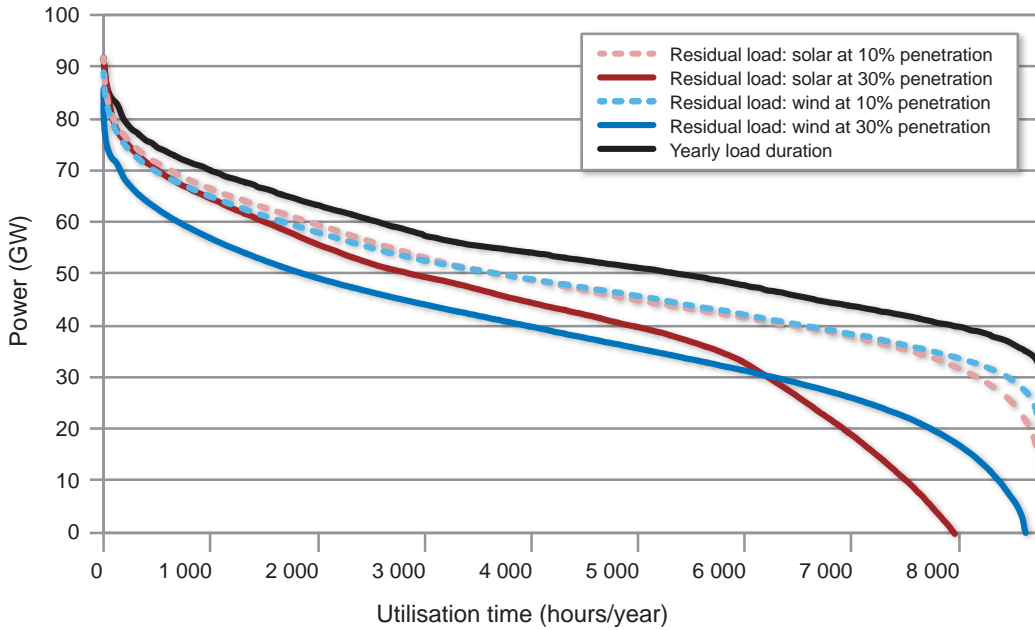
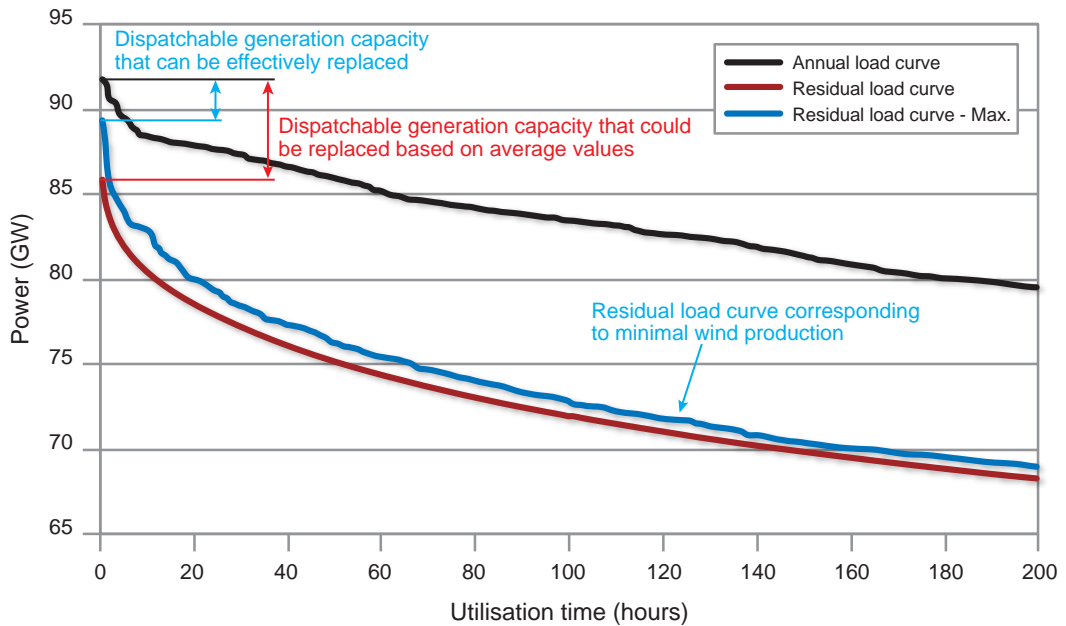

Figure 4.4C: Estimates of wind capacity credit at 30% penetration level in France



### Estimating capacity credit using residual curves

The residual load curves can also be used to calculate, at least in a first approximation, the capacity credit of a variable technology. Figure 4.4C shows a magnified section of the first 200 hours (400 periods of ½ hour length) of the load duration curve, corresponding to the peak demand period: the black line shows the annual duration load curve, while the red line represents the residual load curve, obtained by averaging the 650 independently calculated samples generated by the Monte Carlo process. Finally, the blue line shows the highest values of the residual curve (i.e. the case with the lowest renewable production) observed over the 650 samples. The difference between the peak of the load duration curve and the residual load duration curve represents the generation capacity that, on average, is not required due to the presence of variable wind energy. The difference between the black and the blue curves shows the minimal generation capacity, over all samples, which is not needed.

In order to calculate capacity credit of the variable technologies, the fluctuations of the residual demand peak should be taken into account. In the last edition of the *World Energy Outlook* (IEA, 2011c), the IEA assumes that the annual peak demand is normally distributed around the mean. The capacity credit is then calculated based on the difference between the peak demand and the point one standard deviation above the residual peak demand. The NEA, in the present study, calculated the capacity credit as the difference between the averages of the first 10 hours of the annual load curve and that of the maximal residual load curve (in blue in Figure 4.4C) obtained after a significant amount of independent Monte Carlo calculations (650 trials in the example above). These two different methodologies lead to very similar results.

## **Appendix 4.D**

### **Changes in the optimal generation mix – a hidden system cost**

As observed in the previous sections, the introduction of intermittent renewable energy has a significant effect on the shape of the residual curve that is seen by the electrical system and must be covered by dispatchable technologies. On the long term, the generation mix is likely to be different from the mix that would be required without the investment in variable renewables. In particular, more electricity will be required on the left part of the duration curve using more expensive technologies. An important consequence is that providing the residual load for a system with intermittent renewables will be more costly than for an equivalent system with only dispatchable technologies. This method allows to estimate in a rigorous way the cost for back-up provision for renewable capacity with respect to a system relying on flexible generation by. Both fixed and variable costs are therefore appropriately taken into account here.

For the two penetration level assumed in our study, 10% and 30%, the residual duration curve after the infeed of a low marginal cost dispatchable technology was constructed, assuming a load factor of 85% and an unplanned outage rate of 5%. The residual curve obtained can be directly compared with those resulting from the integration of solar and wind technologies.<sup>34</sup> It is thus possible to derive for each scenario the optimal generation mix which satisfies that residual load at the least-cost. It is then possible to show and quantify those additional costs borne by the whole electrical system.

Figure 4.1D shows the results for the scenario with wind energy at 30% penetration level; residual duration curves are plotted in red for the dispatchable technology and in blue for renewables. When integrating intermittent renewables are present in the electrical system, dispatchable sources must provide more electricity in the periods of high residual demand, when the electricity is more costly, and less electricity in period of low residual demand, when the electricity is cheaper. Those are represented by the areas in blue and in pink, respectively, in Figure 4.1D. The dotted black line in the figure shows the minimal cost for producing electricity as a function of the utilisation time. Another example, for solar this time, is shown in Figure 4.2D.

Table 4.1D provides the results for the four scenarios analysed: at each penetration level are reported the average costs for providing the residual load, normalised by total electricity produced. Integrating intermittent renewable energy into an electrical system increases the cost for providing the residual electricity load. This effect is more significant for solar technology and increases with the penetration level of renewables. At a 10% penetration level, the additional costs borne by the electrical system are about 4 USD/MWh of renewable production the wind scenario, while it reaches about 13 USD/MWh in the solar scenario. These costs almost double at 30% penetration level, reaching 8 USD/MWh and 26 USD/MWh, respectively.

34. In principle, this methodology could be applied for each combination of the two technologies.

**Figure 4.1D: Residual load duration curves and electricity generation cost with and without variable renewables: the case of 30% wind penetration**

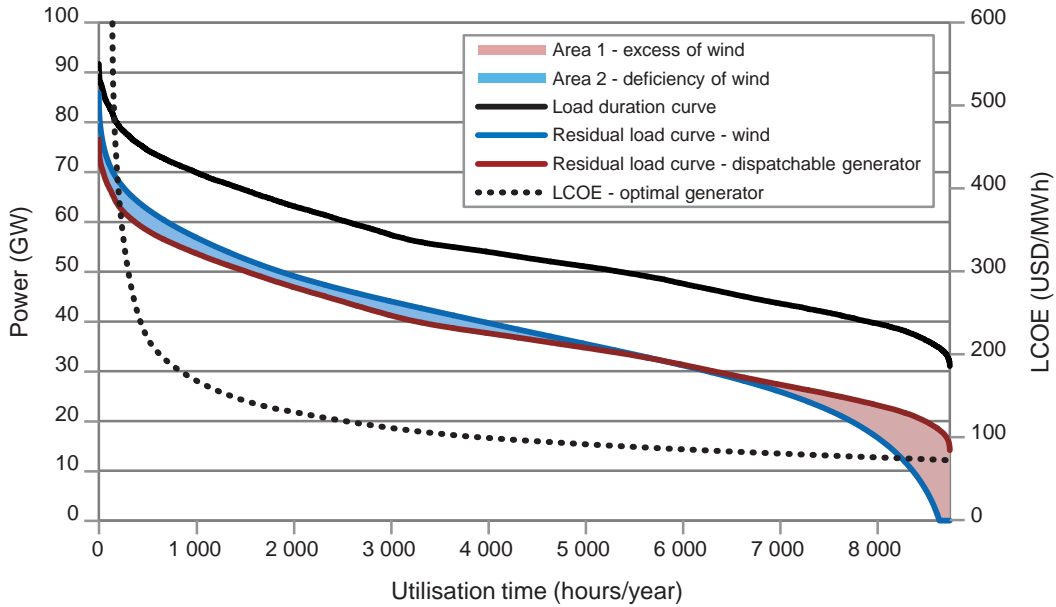

**Figure 4.2D: Residual load duration curves and electricity generation cost with and without variable renewables: the case of solar 30% penetration**

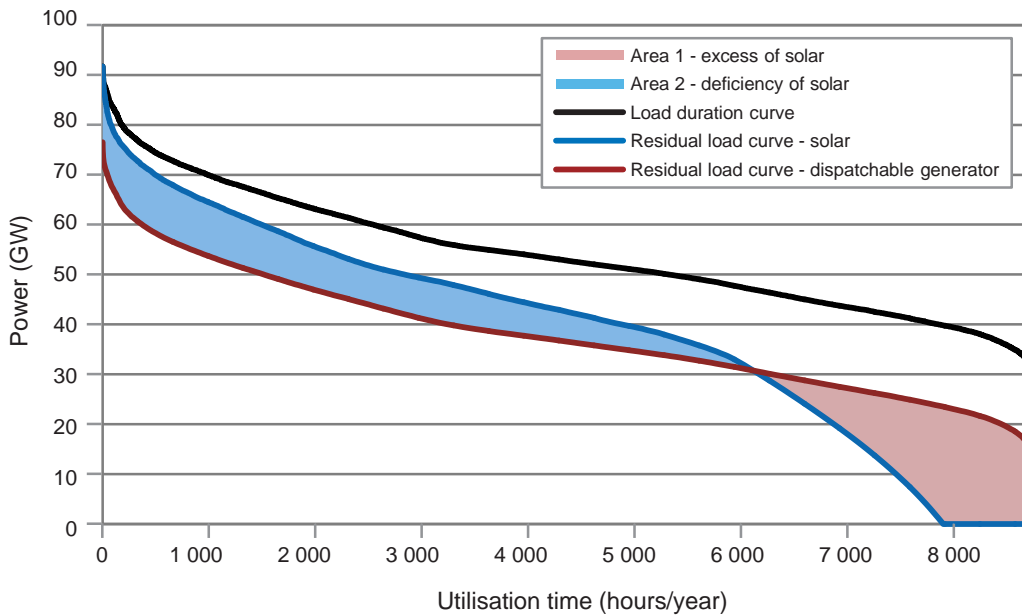

**Table 4.1D: Summary of system cost\***

	10% penetration level			30% penetration level		
	Reference	Wind	Solar	Reference	Wind	Solar
Average cost (USD/MWh)	79.03	79.51	80.49	81.76	85.46	89.81
Additional cost vs. reference (USD/MWh)	-	0.47	1.43	-	3.70	10.68
Additional cost vs. reference (USD/MWh renewables)	-	4.27	12.83	-	8.66	25.80

\* Additional costs with respect to the reference source have been normalised either with respect to total electricity production (second line) or to the electricity produced by renewable sources (third line).

## References

- ARUP (2011), *Review of the Generation Costs and Deployment Potential of Renewable Electricity Technologies in the UK. Study Report*, report commissioned to Ove Arup & Partners Ltd by the Department of Energy and Climate Change, October 2011.
- Barth, R. (2011), *Institutes für Energiewirtschaft und Rationelle Energieanwendung (IER)*, Institute for Energy Economics and the Rational Use of Energy, University of Stuttgart private communication.
- BSW Solar (2012), *Statistic Data on the German Solar Power (photovoltaic) Industry*, BSW Solar, June.
- Bund (2011), Private communication from Bundesnetzagentur für Elektrizität, Gas, Telekommunikation, Post und Eisenbahnen.
- Burgherr, P., S. Hirschberg and E. Cazzoli (2008), *Final Report on Quantification of Risk Indicators for Sustainability Assessment of Future Electricity Supply Options*, NEEDS deliverable No. D7.1, p. 42. Available at <http://gabe.web.psi.ch/research/ra/index.html#pub>.
- Dena (2005), “Integration into the National Grid of Onshore and Offshore Wind Energy Generated in Germany by the Year 2020”, Dena Grid Study I, Deutsche Energie-Agentur (Dena), April, Berlin, Germany.
- Dena (2010), “Integration of Renewable Energy Sources in the German Power Supply System from 2015-2020”, Dena Grid Study II, Deutsche Energie-Agentur (Dena), November, Berlin, Germany.
- DOE (2008), *20% Wind Energy by 2030. Increasing Wind Energy’s Contribution to U.S. Electricity Supply*; US Department of Energy, Energy efficiency and Renewable Energy, June, United States.
- DOE (2010), *Western Wind and Solar Integration Study*, General Electric study, prepared for The National Renewable Energy Laboratory, Department of Energy, May, United States.
- EC (1995), *ExternE: Externalities of Energy*, European Commission, Directorate-General XII, Science, Research and Development, Brussels, Belgium.
- EC (2009), *Promoting Grid-related Incentives for Large Scale RES-E Integration into the Different European Electricity Systems: Action Plan*, European Commission, pp. 12-13, available at [www.eaci-projects.eu/iee/page/Page.jsp?op=project\\_detail&prid=1601&side=downloadablefiles](http://www.eaci-projects.eu/iee/page/Page.jsp?op=project_detail&prid=1601&side=downloadablefiles).
- EC (2010), *Europeans and Nuclear Safety, Special Eurobarometer 324*, European Commission, Brussels, Belgium, p. 48.
- Enerpresse (2012), “L’éolien offshore en voie de déconnexion”, *Enerpresse: Le quotidien de l’énergie*, No. 10510, 16 January 2012, pp. 4-5.
- Ernst & Young (2009), *Cost of and Financial Support for Offshore Wind. A Report for the Department of Energy and Climate Change*, Ernst & Young, 27 April 2009.
- EWIS (2010), *European Wind Integration Study*, EWIS Study, ENTSO-E, April 2010.
- EWITS (2011), *Eastern Wind Integration and Transmission Study*, EWITS Study prepared by EnerNex for the National Renewable Energy Laboratory of the Department of Energy, February.
- Green, R. and N. Vasilakos (2010), *The Long-term Impact of Wind Power on Electricity Prices and Generating Capacity*, University of Birmingham, Discussion paper 11-09. Available at: [www.birmingham.ac.uk/Documents/college-social-sciences/business/economics/2010-papers/economics-papers-2011/economics-papers-2011/11-09.pdf](http://www.birmingham.ac.uk/Documents/college-social-sciences/business/economics/2010-papers/economics-papers-2011/economics-papers-2011/11-09.pdf).
- Green Net (2009a), *Promoting Grid-related Incentives for Large Scale RES-E Integration into the Different European Electricity Systems*, Green-net Europe, May 2009.
- Green Net (2009b), *Guiding a Least Cost Grid Integration of Res-electricity in an Extended Europe*, GreenNet-EU27, Deliverable D5a.



- Hirschberg S., G. Spiekerman and R. Dones (1998), *Severe Accidents in the Energy Sector*, PSI Bericht No. 1998-16, Paul Scherrer Institut, Villingen, Switzerland. Available on <http://gabe.web.psi.ch/research/ra/index.html#pub>.
- Holtinen, H. et al. (2009), *Design and Operation of Power Systems with Large Amounts of Wind Power. Final Report, IEA WIND Task 25, Phase one 2006-2008*, VTT, Finland, Publication available at [www.ieawind.org/AnnexXXV/Task25\\_Publications.html](http://www.ieawind.org/AnnexXXV/Task25_Publications.html).
- IAEA (2009), “Interfacing Nuclear Power Plants with the Electric Grid: the Need for Reliability amid Complexity”, Attachment 5 of *IAEA Nuclear Technology Review 2009*, IAEA, Vienna, Austria. Available at [www.iaea.org/About/Policy/GC/GC53/GC53InfDocuments/English/gc53inf-3-att5\\_en.pdf](http://www.iaea.org/About/Policy/GC/GC53/GC53InfDocuments/English/gc53inf-3-att5_en.pdf).
- IEA (2010a), *National Survey Report of PV Power Applications in the United States 2010*, IEA Co-operative programme on PhotoVoltaic Power Systems, May 2011.
- IEA (2010b), *National Survey Report of PV Power Applications in Republic of Korea 2010*, IEA Co-operative Programme on PhotoVoltaic Power Systems, June 2011.
- IEA (2010c), *National Survey Report of PV Power Applications in France 2010*, IEA Co-operative Programme on PhotoVoltaic Power Systems, May 2011.
- IEA (2011a), *IEA Statistics: Electricity Information (2011 Edition)*, International Energy Agency, OECD, Paris, France.
- IEA (2011b), *Harnessing Variable Renewables, A Guide to the Balancing Challenge*, International Energy Agency, OECD, Paris, France.
- IEA (2011c), *World Energy Outlook*, International Energy Agency, OECD, Paris, France.
- IEA/NEA (2010), *Projected Costs of Generating Electricity: 2010 Edition*, International Energy Agency and Nuclear Energy Agency, OECD, Paris, France.
- IEEE (2011), “Capacity Value of Wind Power”, in A. Keane et al. (2011), *IEEE Transaction on Power System*, May, Vol. 26, Issue 2, pp. 564-572.
- ILEX (2002), *Quantifying the System Costs of Additional Renewable in 2020*, ILEX Energy Consulting Ltd, A report to the Department of Trade and Industry, October, United Kingdom.
- IPCC (2007), *Fourth Assessment Report: Climate Change 2007 – Mitigation of Climate Change*, Chapter 4 Section 4.3.4.1 “Electricity”, Intergovernmental Panel on Climate Change, Geneva, Switzerland, [www.ipcc.ch/publications\\_and\\_data/publications\\_ipcc\\_fourth\\_assessment\\_report\\_wg3\\_report\\_mitigation\\_of\\_climate\\_change.htm](http://www.ipcc.ch/publications_and_data/publications_ipcc_fourth_assessment_report_wg3_report_mitigation_of_climate_change.htm).
- Jones, R. (2012), *Diversity Benefit for Solar and Wind with Increasing Market Penetration. System Capacity Value*, Presentation at the Intersolar 2012 Conference, 9-12 July 2012, San Francisco United States.
- Keppler, J.H. (2010), “Going with Coase against Coase: The Dynamic Approach to the Internalization of External Effects”, in Jean Michel Lasry and Damien Fessler, *The Economics and Finance of Sustainable Development*, Economica, Paris, pp. 118-138.
- Mabel, M., R. Raj and E. Fernandez (2010), “Analysis on Reliability Aspects of Wind Power”, *Renewable and Sustainable Energy Reviews*, 1210-1216.
- MacDonald (2010), *UK Electricity Generation Costs Update*, report commissioned to MacDonald by the Department of Energy and Climate Change, June 2010.
- NEA (2010), *The Security of Energy Supply and the Contribution of Nuclear Energy*, Nuclear Energy Agency, OECD, Paris, France.
- NEA (2011), *Carbon Pricing, Power Markets and the Competitiveness of Nuclear Power*, Nuclear Energy Agency, OECD, Paris, France.
- NEA/IAEA (2012), *Uranium 2011: Resources, Production and Demand*, OECD, Paris, France.

- Nicolosi, M. (2010), “Wind Power Integration, Negative Prices and Power System Flexibility. An Empirical Analysis of Extreme Events in Germany”, Institute of Energy Economics at the University of Cologne, March 2010, *EWI Working Paper*, No. 10/01.
- ORNL (1992-1998), *Estimating Externalities of Fuel Cycles* (8 vols.), Oak Ridge National Laboratory and Resources for the Future, Washington, D.C., United States.
- Parsons (2011), *Electricity Generation Cost Model – 2011 Update Revision 1*, report commissioned to Parsons Brinckerhoff by the Department of Energy and Climate Change, August 2011.
- Parsons (2012), *Solar PV Cost Update. January 2012*, report commissioned to Parsons Brinckerhoff by the Department of Energy and Climate Change, January 2012. Available online at [www.decc.gov.uk/assets/decc/11/meeting-energy-demand/renewable-energy/4290-solar-pv-cost-update-report--3-feb-2012-.pdf](http://www.decc.gov.uk/assets/decc/11/meeting-energy-demand/renewable-energy/4290-solar-pv-cost-update-report--3-feb-2012-.pdf).
- Redpoint (2008), *Implementation of EU 2020 Renewable Target in the UK Electricity Sector: Renewable Support Schemes*, Redpoint Energy, Trilemma UK and University of Cambridge, report for the Department of Business, Enterprise and Regulatory Reform, June 2008.
- RTE (2011), *Generation Adequacy Report on the Electricity Supply – Demand Balance in France – Edition 2011*, RET-France, Paris, France. Available at [www.rte-france.com/uploads/Mediatheque\\_docs/vie\\_systeme/annuelles/bilan\\_previsiennel/an/generation\\_adequacy\\_report\\_2011.pdf](http://www.rte-france.com/uploads/Mediatheque_docs/vie_systeme/annuelles/bilan_previsiennel/an/generation_adequacy_report_2011.pdf).
- Saenz de Miera, G., P. del Rio Gonzales and I. Vizcaino (2008), “Analysing the Impact of Renewable Electricity Support Schemes on Power Prices: The Case of Wind Electricity in Spain”, *Energy Policy*, Vol. 36, No. 9, pp. 3345-3359.
- Satka, V. (2010), *Capacity Value of Wind Power in Finland*, Master thesis.
- Scheepers, M.J.J., A.J. Seebregts, J.J. de Jong, J.M. Maters (2007), *EU Standards for Energy Security of Supply – Updates on the Crisis Capability Index and the Supply/Demand Index. Quantification for EU-27*, ECN-E--07-004, April 2007, Energy Research Centre of the Netherlands and Clingendael International Energy Program, Petten/Amsterdam/The Hague.
- Sensfuss (2008), “The Merit Order Effect: A Detailed Analysis of the Price Effect of Renewable Electricity Generation on Spot Market Prices in Germany”, F. Sensfuss, M. Ragwitz and M. Genoese, *Energy Policy*, Vol. 36, No. 8, pp. 3076-3084.
- SEPA (2008), *Photovoltaic Capacity Valuation Methods*, T. Hoff, R. Perez, J.P. Ross and M. Tylor, Solar Electric Power Association, Report No. 02-08, May 2008.
- Vandezande, L., L. Meeus, R. Belmans, Saguan, M. and J.M. Glachand (2010), “Well-functioning Balancing Markets: A Prerequisite for Wind Power Integration”, *Energy Policy*, Vol. 38, Issue 7, pp. 3147-3154.
- Verseille, J. (2003), *Growth and Grids – Panel Discussion on Issues of Grid Extension, Supply Predictability and Power Quality*, European Wind Energy Conference 2003, Madrid, 16-19 June.
- Wayne (1999), *A Procedure for Estimating Loss of Life Caused by Dam Failure*, J. Wayne and P.E. Graham, US Department of Interior, Bureau of Reclamation, Dam Safety Office, Denver, Colorado, September.
- Weigt, H., T. Jeske, F. Leuthold and C. von Hirschhausen (2010), “Take the Long Way Down: Integration of Large-scale North Sea Wind Using HVDC Transmission”, *Energy Policy*, Vol. 38, Issue 7, pp. 3164-3173.
- Winkel, M. (2012), “Katastrophe für Offshore”, *Frankfurter Rundschau*, 14 February 2012 at [www.fr-online.de/energie/windenergie--katastrophe-fuer-offshore-,1473634,11629752,item,0.html](http://www.fr-online.de/energie/windenergie--katastrophe-fuer-offshore-,1473634,11629752,item,0.html).

## Chapter 5

# Regulatory frameworks for the internalisation of system effects and the adequate remuneration of flexibility services

### 5.1 Introduction

The electricity markets of OECD countries still have to find a steady state for the stable and reliable provision of electricity that is both low cost and low carbon. This is *inter alia* due to the significant and so far largely underestimated system effects of subsidised, variable renewables. Progressive liberalisation and public sector reforms in the 1980s and 1990s were aimed at improving reliability and efficiency as well as lowering prices through increased competition. Since the late 1990s, climate change concerns and the desire to reduce greenhouse gas emissions have added an additional layer of policy instruments. The electricity sector remains, of course, a significant emitter of carbon dioxide, in particular in those OECD countries relying heavily on coal- and gas-fired generation. However, given its limited exposure to international competition, it was also identified quickly as the principal vector for policy efforts to reduce greenhouse gas emissions.

Decarbonising a power sector implies introducing large amounts of low-carbon generation sources such as nuclear energy and renewable energies. Given their limited competitiveness, the exception being hydropower, which however is not widely available, all OECD governments have to some extent subsidise the use of renewable energies, in particular wind and solar power. Both, however, rely on the use of natural resources which are variable and difficult to predict. Their variability and unpredictability causes sudden changes in electricity dispatch and poses challenges for the smooth working of the electrical system. As highlighted in Chapter 1, these system effects constitute negative externalities that need to be addressed either through the use of dispatchable forms of electricity generation such as coal, gas or nuclear or through improved interconnections, storage or demand responses. In the following, this chapter will focus on the regulatory frameworks necessary in order to internalise the negative externalities generated by the variability and unpredictability of variable renewables.

In principle, geographical and technological diversification of variable renewables can smooth variability, and better forecasting of supply can reduce unpredictability. Both may contribute to mitigate the system effects of variable renewables. However, the ambitious policy objectives of OECD countries imply that even if these mitigating factors are properly implemented and improved, larger aggregated shares of variable renewables will increase the overall variability of electricity supply and the consequent cost for the electricity system. This poses challenges to policy-makers to improve market designs in order to mitigate the negative system effects of variable renewables and to enable and properly remunerate the stabilising contribution from nuclear power and other dispatchable providers of flexibility in the decarbonising electricity markets of OECD countries.

As discussed in Chapter 4, the grid-based system effects of variable renewable power generation sources can be classified, on the one hand, as relating to increased investment needs for grid reinforcement, extension and connection and, on the other hand, to the need to provide short-term balancing services and long-term back-up capabilities. The former require the formulation of appropriate investment plans, their approval by the regulator and their financing by the respective producers or by general electricity consumers through grid tariffs. As shown in the previous chapter, the sums involved can be considerable, reaching up to 50% of plant-level investment costs for new power generation investments, in particular for offshore wind, which suffers from the high costs of network connection. Nevertheless, the issue can be handled from an institutional point of view with existing regulatory frameworks.

New and innovative institutional, regulatory and financial frameworks need to be devised for the provision of so-called “flexibility services”, in particular the provision of short-term balancing services as well as long-term capacity, primarily through dispatchable power supplies from conventional resources. There are essentially four dimensions, in which one may consider providing the necessary balancing and capacity services to ensure the balance between demand and supply in electricity systems with significant shares of variable renewables:

- short-term spinning reserves and long-term capacity provided by dispatchable, conventional power generation resources;
- the extension of existing market interconnections;
- storage in order to have short-term power reserves available in time of need;
- demand-side management measures in order to curb demand in case of supply shortfalls.

This chapter will present and discuss the structural adjustments and regulatory frameworks required to solicit the necessary flexibility responses in these four dimensions. Building on the more technical previous chapters, this chapter looks at the adequacy of current arrangements and the necessary future evolutions in the electricity sectors of OECD countries to optimise the provision of “flexibility services” in the face of high volatility of load and large amounts of variable renewables. The integration of variable renewable energies requires new and appropriate regulatory and operational frameworks to properly move towards more efficient and reliable low-carbon electricity systems.

A particular role in this context is played by capacity markets. While their name implies a focus on the long run availability of power generating capacity, their true role could be much larger. Capacity markets could actually play a key role in integrating different flexibility services – including short-term demand curtailment, storage, access to interconnections, and, of course, capacity itself – in a single framework, where decisions are made at the margin according to the variable costs of different options over different time frames.

Last but not least, the different support policies for variable renewable energies such as wind and solar that are currently in place in OECD countries have different impacts on the efficiency of the market in its entirety and the profitability of alternative producers. Identical policy objectives can thus be achieved at different social costs, which is why a concluding section will pay attention to this aspect.

The remainder of this chapter will identify the changes required in current institutional and regulatory set-ups of the electricity industry to find the most efficient responses to the challenge posed by increasing shares of variable renewables. It will be organised in three sections. Section 5.2 will look at the efficient provision of flexibility through short-term balancing services and long-term dispatchable back-up capacity, interconnections, storage and demand-side management. Section 5.3 will consider current experiences with different market designs for capacity provision in all its forms. Section 5.4 will propose how to improve renewable energy support policies to minimise market distortions and system effects. Altogether, the chapter aims at providing the outline for an electricity sector that allows variable renewables to coexist with nuclear energy as a dispatchable low-carbon source of electricity in the power sectors of OECD countries operating under increasingly stringent carbon constraints.

## **5.2 Dispatchable back-up capacity, interconnections, storage and demand response: four options for the provision of flexibility services**

As mentioned above, there exist essentially four different dimensions, dispatchable back-up capacity, interconnections, storage and demand response, that could facilitate the integration of variable renewables into electricity systems. Each one of these provides system flexibility to mitigate the system effects of variable renewables. Each one also requires long-term planning as specific technical infrastructures (i.e. storage facilities, interconnections, physical devices to allow real-time metering, etc.) need to be deployed and carefully prepared to garner the necessary political and social support. While direct support policies for renewable technologies frequently enjoy broad support in OECD countries, the accompanying measures necessary to ensure continuing security of electricity supply are often viewed much less favourably. One of the objectives of this study is to show that these two aspects necessarily imply each other and cannot be divorced. Variable renewables, whatever their intrinsic merits, require a substantial provision of short-run and long-run flexibility services that come at a cost.

### **Short-term balancing and long-run adequacy provided by dispatchable back-up capacity**

Having enough dispatchable electricity generation capacity available in the short term to respond to the volatility of intermittent supplies and in the long term to cover demand is a critical point for policy-makers and regulators. It is all the more relevant as the introduction of large amounts of variable renewable energies at low marginal costs has a significant impact on market prices: the decrease of average prices and the increase in their volatility reduce incentives for investments in new generating capacity (Traber and Kemfert, 2009).

Two time horizons will be used to characterise the ability of electricity system to integrate large amounts of renewable energies. In the short term, instantaneous demand has to be covered by the production of the different available assets in a certain geographical area. Due to the variability and unpredictability of variable renewables, this means that a number of dispatchable power plants will need to be working at a reduced power level or be kept in stand-by in order to provide balancing services. In the long term, investments in power generation will need to be adequate to fully meet future electricity demand at all times including, for instance, during early evening on a cold winter day in the middle of the week when no wind is blowing and interconnections are saturated.

In the short run, there exist challenges associated with the unpredictability as well as the variability of renewable technologies. Unpredictable generation from variable renewables requires significant amounts of costly “spinning reserves” in order to be available at short notice to provide load to the grid in case renewable generation should fall short of forecasts. Dispatchable power plants also need to change their load more frequently (ramping) as a function of the variable load from renewables, even if the latter’s contribution could be predicted with certainty. The resulting short-term “balancing costs” thus correspond primarily to the variable costs of power plants providing spinning reserves as well as their cost increases due to more frequent ramping up and down of electric load.

Balancing costs are situated at the boundary between regular production costs and the provision of services for primary and secondary frequency control and are usually grouped together with the latter under the heading of “ancillary services”, such as the provision of primary or secondary reserves (see Chapter 2). It is quite clear that balancing costs would decline with the precision of the forecasts of wind and solar production. While there are balancing costs in all electricity systems in order to account for unforeseen outages, grid incidents and the like, the variability of renewables – to the extent that it is predictable – would not generate any additional increases.<sup>1</sup> If renewable production is strong and correctly predicted, spinning reserves will be at a minimum, and if renewable production is weak, conventional power plants will be working at high capacity factors but they will also earn revenue on the electricity they produce.

In the long run, the key issue is the availability of adequate capacity at all times. The provision of this particular flexibility service depends mostly on the fixed investment costs of the dispatchable technologies serving as back-up, since they will frequently be used at load factors that are significantly lower than what is technically feasible and commercially desirable. The costs for providing system adequacy are tightly linked with the low capacity credit of variable renewable power plants and the fact that these will need dispatchable back-up capacities to cover periods when variable renewable plants are not fully or not at all available for producing electricity. The question here is not the predictability but only the variability of renewable supplies.

The final contribution of a given renewable technology with variable production to the adequacy of an electricity system is a function of its correlation with demand in a specific setting of an OECD member country as much as its load factor. Solar power, which in many OECD countries has much lower load factors than wind power, especially offshore wind, may nevertheless have comparable system costs in terms of its needs for dispatchable back-up capacity to ensure system adequacy. This is due to the fact that, depending on local circumstances, its capacity credit (the amount of capacity that does not

1. This does, of course, not mean that variable renewables would no longer generate additional system costs. In addition to the reinforcement and extension of the grid, the need to cover strongly varying residual load would not only continue to generate long-run adequacy costs but also impose added ramp costs on dispatchable operators. The latter have not been accounted for explicitly in this study due to data issues but have been qualitatively discussed in the context of load following of nuclear plants and should not be neglected in a more complete analysis.

require matching to guarantee supply at all times by dispatchable capacity), maybe as high, or higher, than that of wind. For instance in California, where peak demand is reached in the middle of the day due to air conditioning, solar power, which reaches its maximum contribution with some regularity during almost the same hours, has a relatively high capacity credit (this rather favourable situation in California and the south-western United States cannot be extrapolated to the rest of the United States). In France instead where peak demand is reached in winter evenings due to electric heating, solar power will only have a very small or zero capacity credit as dispatchable units will need to cover the whole of peak demand.

This observation underlines the fact already established in Chapter 4 that system effects for the same technology can vary enormously between different countries due to differences in climate, the structure of the surrounding energy system and the shape of the daily and seasonal demand curve.

### *The provision of short-term balancing services*

One of the best researched aspects of the impact of variable renewables on integrated electricity systems are the balancing costs associated with unpredictability and variability of certain renewables. These costs differ among countries as they depend, among other aspects, on the level of variable renewable penetration, on the type and marginal costs of reserve plants and on the quality and accuracy of weather forecasts. The difficulty of the variability challenge is essentially a function of time (IEA, 2011). The increase in shares of variable renewables in electricity markets requires additional balancing to guarantee the continuous matching of supply and demand in real time. This requires second for second the provision of the appropriate ancillary services to ensure the integrity and stability of the grid by controlling power quality, voltage levels and frequency.

These services are contracted from dispatchable power generators according to different mechanisms and the costs are distributed to all network users. EURELECTRIC classifies these individual ancillary services as: frequency control, voltage control, spinning reserve, standing reserve, black start capacity, remote automatic generation control, grid loss compensation, emergency control actions and others (EURELECTRIC, 2004).

The balancing services required for dealing with the variability and unpredictability of certain renewable technologies are related to the provision of spinning reserves and standing reserves, the latter being distinguished from the former by having a slightly lower level of responsiveness but in return somewhat lower variable costs. In other words, during standing reserve the power plant in question is not working at full throttle. Balancing services are not a new phenomenon (see Figure 5.1). However, the advent of large amounts of variable renewables has substantially altered the amounts and the time frames in which they are required. From seasonal balancing in the past, such services today need to be provided at a daily and hourly level as a function of renewable load provision due to, in this example, the varying strength of the wind in Denmark, where more than 25% of installed capacity consists of wind turbines.

**Figure 5.1: Old and new balancing challenges in the Nordic system**

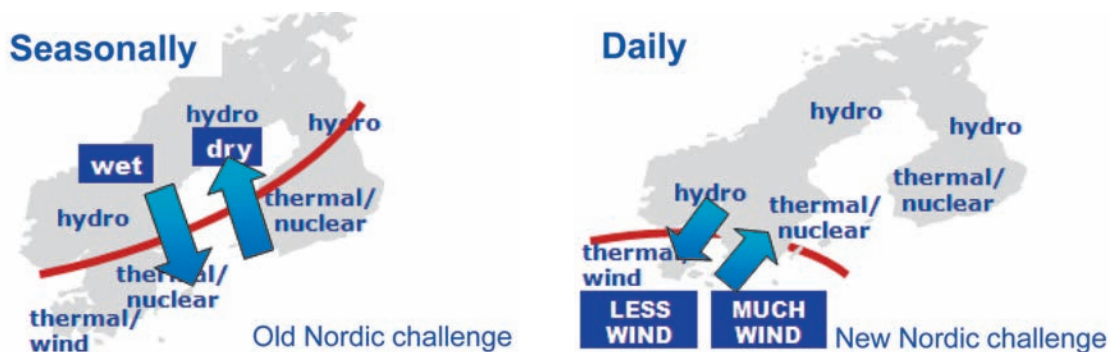

Source: FINGRID, 2011.

### *Long-term adequacy of dispatchable capacity*

In addition to the balancing challenge, which to some extent is a question of forecast accuracy, the crucial challenge of an electricity system is to be able to meet the peak demand in a reliable manner. In order to efficiently accommodate larger amounts or variable renewable energies, additional flexibility from baseload power plants is necessary to guarantee system adequacy.

Due to their low load factors, irregular load and limited correlation with demand, capacity from variable resources such as wind needs to be matched almost one by one by dispatchable capacity in order to guarantee system adequacy. Estimates vary as a function of load factors, co-ordination of load with demand, as well as the geographical and technological spread of intermittent resources. Nevertheless, capacity credits remain low in the best of cases, usually in the 10% range or below. Furthermore, the capacity credit declines with increasing penetration of variable renewable resources, as stable 24 hour demand needs to be met and the system no longer can rely on the fortuitous matching of intermittent supply and peak demand.

Of course, also dispatchable plants do not have 100% availability due to maintenance, shutdowns or unplanned outages. Their advantage, however, is that such outages are rarely correlated and can frequently be co-ordinated over time (see Chapter 3). Nevertheless, even systems based on dispatchable conventional technologies will need to ensure generous “capacity margins” over peak demand. Organisations such as Capgemini in Europe follow up the adequacy of the European control areas closely (Capgemini, 2011).

From a technical perspective, with the introduction of large amounts of variable renewables into power systems, more flexible back-up capacities will be required to ensure continuous supply. Existing dispatchable power plants can be classified from a flexibility contribution perspective depending on their ability to alter their outputs:

- **Peaking plants:** Hydropower reservoir or open cycle gas and diesel turbines can quickly respond to system variations and adapt their output almost at second’s notice. These highly flexible plants are thus ideally placed to provide ancillary service during real-time market operation as well as back-up capacity in balancing markets thus responding to instantaneous variability and forecast uncertainty. Hydropower reservoirs, however, are not available everywhere and peaking power turbines have very high marginal costs; both technologies are thus available only for relatively small, short-run discrepancies between desired and actual supply.
- **Mid-merit and baseload plants:** These plants respond more slowly than peaking plants to demand variability, usually in a matter of several minutes or even hours, if supply variations need to be very large. Coal, CSP plants, combined cycle power plants and, of course, nuclear power plants can all modulate their load and constitute important sources of flexibility for larger gaps between demand and supply due to the intermittency of variable renewables.

Nuclear energy plays a key role in providing system services for back-up capacity in order to ensure continuous matching of supply and demand in the long run. As shown in Chapter 3, modern nuclear plants with light water reactors have significant manoeuvring capabilities. Nuclear load following can thus respond to different system requirements to provide more flexible resources. In Germany, with large penetration of variable resources, nuclear has shown high levels of adaptability in load following mode (see Figure 3.4 in Chapter 3). Also, in France, with high levels of nuclear to cover demand, some nuclear power plants participate in primary and secondary frequency control and some are operated in a load following mode to adapt supply to demand.

While nuclear energy is not the only option for the large-scale provision of back-up capacity, it is the only one to do so without emitting climate change inducing greenhouse gases, whose reduction was the primary reason for developing renewables in the first place.

### Interconnections and market extension

Sometimes it is more convenient and less costly to import electricity from abroad in times of supply shortfalls rather than to maintain extensive back-up capabilities. *Vice versa* it can be more profitable to sell surplus electricity abroad rather than to find clients in a saturated market or to reduce supply. In addition to domestic back-up capabilities, international interconnections thus play an important role in maintaining the supply and demand balance. In some cases, this allows countries to gain reciprocal benefits from complementary structures of both production and demand. French nuclear baseload production exported around the clock can thus be exchanged against German or Swiss electricity produced by wind, gas or hydropower at peak times. Similar trade-offs can happen on the demand side, since the aggregated demand is smoother than that of each individual market. Other things being equal, the larger the market, the more of such mutually beneficial trading possibilities will arise.

Furthermore, larger interconnected systems are more robust in the case of unforeseen technical failures. Appropriate incentives for adequate investments in electricity grids and transmission capacity are thus important to contribute to ensure system adequacy, as larger interconnection capacity improves system flexibility. Interconnections are key to overcoming congestion and bottlenecks in electricity transmission and contribute to the alleviation of variability through two interrelated effects: (1) the technological and geographical spread of variable renewables; and (2) the pooling of conventional capacity (nuclear, hydro, coal and gas) available for flexible dispatch.

Market coupling and proper planning of the interconnection capacity along with renewable energy planned facilities are central to integrating large amounts of variable renewables efficiently. More centralised market designs can help to improve co-ordination and dispatch efficiency in order to reduce the integration costs of variable renewables. In order to advance towards more integrated systems, it is important to promote common rules and schedules for capacity allocation. Differences in technical features among markets might hamper energy trade among different zones, for example time differences in gate closure or informational asymmetries might represent obstacles to energy trade. Greater harmonisation would thus reduce transaction costs and increase benefits.

However, the relevance of these observations depends on the extent to which production in different trading zones is negatively rather than positively correlated. Atmospheric conditions that generate little wind or sunshine and would limit the production from variable renewables in one country, might also affect production in a neighbouring country. Interconnections thus contribute to the integrity and stability of grid operations only to the extent that production structures on both sides are complementary. Once this is the case, real-time co-ordination among system operators is important for system flexibility both in the short-term balancing market and in long-term adequacy provision. Connected areas can participate in a single market, pooling balancing responsibilities as dispatchable balancing resources can be shared through market coupling. Such co-ordination among system operators requires strong technical infrastructures. The term balancing area can imply different degrees of integration depending on different constraints: transportation capacity, power generation adequacy, availability of dispatchable resources and so forth. Geographical and technological diversity also contributes to better integration. Larger interconnected areas will allow larger balancing areas with smoother variable renewable output. In general, increased levels of interconnections and cross-region co-operation in the form of market coupling and congestion management will facilitate the accommodation of variable renewable energies.

Integration of independent regions under a single balancing area might even be an initial step towards a full integration of both regions on a single market. As part of its Trans European Energy Networks (TEEN) initiative, the European Commission is thus driving the evolution of the current transmission grid towards a “super grid” to ensure reliable electricity supply, in particular to provide balancing services across Europe. This will add flexibility in a future unified single electricity system able to transfer capacity services over long distances. Its purpose is to complement the ambitious European renewable targets, which aim at 20% of energy supply from renewable resources by 2020.

By increasing interconnections, the European Commission wants to enable the joint provision of balancing services across countries with different generation profiles. Different policy measures to achieve this objective are:



- High voltage direct current transmission lines would link remote areas with high shares of renewable energy production (offshore wind) to the main grid.
- New institutional arrangements for increased co-operation between electricity operators and regulators: the European Network of Transmission System Operators for Electricity (ENTSO-E).
- Dedicated research, development and implementation programmes to improve the “intelligence” of the grid will allow higher degrees of demand-side participation under programmes.

Improving the interconnections between European member countries can help integrating variable renewables. In the case of France and Germany, for instance, interconnections can provide Germany with back-up capacity for its variable renewables from French nuclear power plants. In moments of higher variable renewable production, French power plants operated in a load following mode can reduce their output to efficiently integrate low-cost renewable energy. This is why European policy-makers have ambitious objectives for the level of interconnections in Europe by 2020 (see Figure 5.2).

**Figure 5.2: European objectives for interconnection capacity in 2020  
(MW, PRIMES Reference Scenario)**

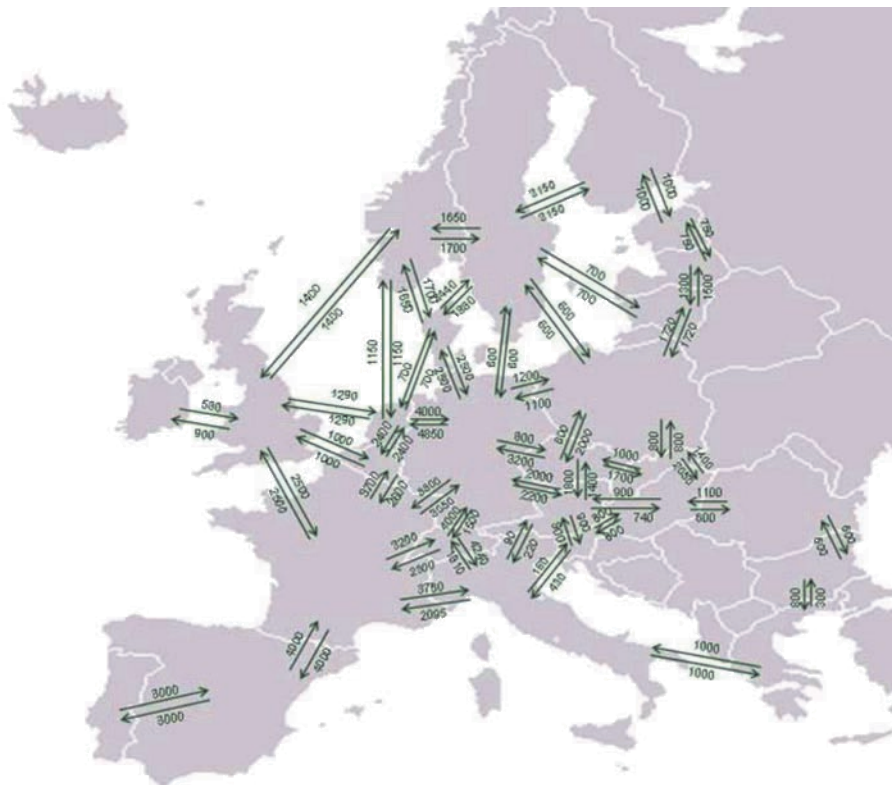

Source: EC, 2011, p. 29.

In parallel to the European effort to integrate European markets, US regulators also enforce greater market integration over large areas by enlarging balancing areas. There exist, for instance, ambitious objectives to establish the Eastern Interconnection by 2024 as outlined in the Eastern Wind Integration and Transmission study (NREL, 2011).

### *Improving the use of interconnection and transport capacity*

Optimal use of existing transport infrastructures demands (a) reliable assessments of the effective transfer capacity and (b) an efficient economic allocation of effectively available capacity. One of the technical issues affecting transfer capacity is that weather conditions have an impact on the performance of transmission and distribution networks. In particular, higher temperatures reduce the effectiveness of electricity transportation capacity. The maximum capacity is usually calculated considering the worst-case ambient values. Correct forecasting is crucial in this context. ECOFYS (2008), for instance, estimates that if ambient conditions could be monitored on a real-time basis, transmission capacities could be increased up to 50%. In order to improve the allocation and use of scarce interconnection capacity, there exist different mechanisms.

*Explicit capacity auctions* consist of trading transmission capacity separately from the marketplaces where electricity is traded. It is considered a simpler method than implicit auctioning (see below). Capacity can be traded on an annual, monthly or daily basis. Explicit capacity auctions can represent a constraint to system flexibility as transmission capacity and electricity generation are negotiated separately. However, this method can also create inefficiencies as complementarities between transport and generation are not taken into account (for instance, production at facilities that require longer transportation) and can impact social welfare, lessen price convergence and lead to suboptimal use of generation and transmission facilities. In principle, however, such inefficiencies should be competed away if companies have the right to resell acquired capacity and transaction and information costs are sufficiently low.

*Implicit capacity auctions* instead include the transmission capacity constraint into the auctioning of electricity itself. Implicit capacity auctioning takes into consideration the transmission capacity between bidding areas and integrates its cost into the spot price. Resulting market prices reflect both the cost of energy in each internal bidding area (price area) and the cost of congestion. Geographical market signals based on these two constraints ensure that electricity flows from the surplus areas (low price areas) towards the deficit areas (high price areas) thus leading to price convergence. Implicit auctions will reinforce short-term system flexibility. By extension, implicit capacity auctions may be considered also for long-term capacity markets, ensuring in the long term not only generation adequacy but also transmission adequacy (NordPool Spot, 2011). Their disadvantages, however, are high informational complexity and the need for heavy information and communications infrastructure to process the complex algorithms required to calculate equilibrium prices.

*Integrated congestion management* attempts to optimise market infrastructures for capacity allocation and electricity production from the start. This methodological approach to congestion management is an important issue in Europe where regulation is not only trying to promote low-carbon technologies but also boosting European power markets to be integrated into a single common power market. Some of these market design strategies for an effective congestion management at the European level are the following ones (Neuhoff, Hobbs and Newbery, 2011):

- Integrated approach of national and international congestion management.
- Joint allocation by TSOs of international transmission rights using real-time dynamic processes for bilateral transfers.
- Integration of congestion management with day-ahead energy markets. Integrated centralised auction platforms can achieve more efficient market outcomes.
- Integration of congestion management with intraday and balancing markets.
- Increased transparency of congestion.

These strategies target congestion inefficiencies within and between countries as well as inefficiencies related to dynamic management. The logic behind these proposals is once more to mitigate physical network expansion costs through a more efficient utilisation of the network by providing higher degrees of flexibility in order to deal with significant shares of variable renewables.

## Electricity storage

One of the defining characteristics of electricity markets is the lack of low-cost storage for electricity on any significant scale. Storage can be considered a buffer between supply and demand. Its absence creates the need for second-to-second matching of supply and demand typical for the electricity sector. Without large-scale storage facilities, generation and consumption need to be coupled in real time and scheduled electricity generation using dispatchable technologies is the prevailing strategy to contribute to cover demand. With the introduction of variable renewable technologies on electricity grids, the question of the availability of large scale energy storage infrastructures, even at significant cost, arises again as they would allow to greatly improve system manageability, controllability and flexibility of supply. Storage facilities would increase system security by storing variable renewable electricity produced during low demand periods and using it during high demand or peak periods. Two main functions of electricity storage in electricity markets can be distinguished: balancing of electricity flows and provision of short-term ancillary services. Concerning the contribution of energy storage to improve electricity balancing, the following points can be outlined:

- Balancing of electricity flows using energy storage can help improve power generation economics of variable renewable generation technologies by storing residual production at low demand periods and avoid curtailment in case of excess of variable production.
- Storage can help to substantially reduce variable renewable integration system costs by allowing dispatchable technologies to generate in more stable and constant modes with higher load factors and lower operational costs.
- Storage can help optimise the use of scarce transmission capacities.
- Storage can reduce variable renewable back-up integration costs by providing back-up capacity. This back-up capacity is considered to be of added value as it is low-carbon electricity production.
- Storage can provide ancillary services at the system level (in a second or minute scale) such as primary and secondary frequency control.

The debate can be framed in terms of system efficiency and what is more cost effective concerning system stability provision: the internalisation of system costs by variable renewable producers or the provision of ancillary services for system stability by other producers. This controversial debate is illustrated by Nyamdash, Denny and O'Malley for the Irish electricity system (Nyamdash *et al.*, 2010). The study shows that in order to provide the necessary flexibility for an increase of wind capacity to 2 550 MW, it would be cheaper to work with appropriately managed back-up capacity rather than with storage technologies that at current prices are still too expensive.

Other studies also assess the economic viability of storage (see Loisel *et al.*, 2010). Since storage needs to be able to recover its costs by selling energy to the market or other services as ancillary services, regulators should set up the necessary signals to allow storage operators to capture the benefit of variations in the short run marginal costs of generation. Energy-only wholesale markets currently are not prepared to integrate storage resources efficiently, even if storage provides a socially beneficial service. Storage just as back-up capacity will not be able to recuperate privately the full social value of its balancing contribution and security of supply in a “power-only” market. Likewise, regulatory regimes should compensate not only economic services but also socially beneficial services by remunerating wholesale price arbitration, the provision of ancillary services, avoidance of variable renewable curtailment, better congestion management and, in general, a smoother working of the market mechanisms with less volatility.

### **Box 5.1** **Examples of storage technologies**

Pump storage is globally the most widely deployed storage technology with around 130 GW of installed capacity. Nevertheless, other technologies are being developed or already exist and could be used commercially for large scale energy storage if the right market signals and regulatory frameworks would exist. These technologies allow renewable smoothing, provide ramping capacity and peak shifting. One of these technologies is compressed air energy storage (CAES). CAES technology consists of using off-peak power and the elastic energy of air to store energy. This energy can be stored in aquifers, salt domes or caverns. Compressed stored air is used in combination with a turbine compressor, thus increasing efficiency. Three CAES pilot facilities can be found in McIntosh, Alabama (110 MW), Watkins Glen, New York (180 MW), or Huntorf, Germany (290 MW). Recent research has focused on adiabatic CAES (AA-CAES). With this technology, both the compressed air and the heat resulting from the compression are stored. AA-CAES technology does not require the installation of a complementary gas plant, thus increasing the efficiency of the storage process.

Support mechanisms could be (as it is the case with other technologies such as renewables) based on the social benefit they generate. Storage support mechanisms, as in the case of renewable technologies, could be conceived in a supply push basis (capital grants, tax exemptions, etc.) or in a demand pull basis (FITs, green auctions, etc.). Overall, the economic benefits of reserve capacity provision by storage facilities in scenarios with large amounts of variable renewables will depend on the storage technology envisioned, market design and the technological characteristics of the particular market under consideration.

#### **Demand-side management**

Demand-side adjustment, in particular in the form of demand curtailing during periods of high prices, can also actively contribute to system flexibility. While regulators and market operators have focused on establishing market signals for supply side participants, so far few signals are available for demand-side participants. In a transition towards greater degrees of active demand-side participation, with appropriate market signals and infrastructure, demand might be managed by distributors on a contractual basis. This is known as demand-side management in contrast to direct demand-side participation (demand response). Demand-side management can contribute to achieving higher levels of variable renewable penetration and to guarantee system adequacy and system reliability through a variety of mechanisms:

*Smart grids* allow reducing the gap between electricity demand and supply at several levels (see also Section 6.1 for an extensive discussion). Smart grids will be a key element to allow the integration of the demand side, including increased responsiveness of consumers in market activities and improve market efficiency and reliability. Smart grids will be able to integrate large amounts of renewable energies that can be connected at different voltage levels, in multi-directional “flows”, reinforcing the distributed production (distributed energy resources) and distributed storage control like the vehicle-to-grid (V2G) initiative that uses the distributed storage capacity of electric vehicles as a resource to provide system flexibility.<sup>2</sup> Smart-grids initiatives have already been conceived in several OECD countries, for example the European Commission initiative on “Smart Grids” (European Commission, 2005).<sup>3</sup> South Korea plans to spend USD 24 billion over the next two decades on smart grids to make South Korea’s electricity distribution more efficient, cut greenhouse gas emissions and save USD 26 billion in energy imports. A smart grid demonstration project is currently underway in the island of Jeju.

*Smart meters, real-time pricing and demand response.* The ability to collect and transmit real-time data as well as measurement devices permitting two-way communication allow for remote reading and greater demand-side participation. Smart meters also offer a broader set of tariffs based on real-time prices.

2. Distributed energy resources are small-scale power generation technologies (typically in the range of 3 to 10 000 kW) located close to where electricity is used (e.g. a home or business) to provide an alternative to or an enhancement of the traditional electric power system (California Energy Commission, 2008).

3. Refers to [www.smartgrids.eu/](http://www.smartgrids.eu/).

Such real-time participation can improve variable renewable integration to the extent that consumers will be willing to react to short-term market signals. This requires the installation of advanced metering stations at demand points able to manage the real-time information provided by the system operator. Smart metering can thus provide benefits for different groups of market participants as well as for the overall efficiency improvement of electricity system (see Figure 5.3).

**Figure 5.3: The advantages of smart metering for different stakeholders**



Source: Capgemini, 2008.

*Contractual demand-side management* can also actively contribute to achieve more flexibility in the electricity sector. The implementation of DSM usually implies using peak pricing rates to induce consumers to reduce load during peak times. Such “load migration” policies seek to flatten the load curve by reducing consumption during peak price periods and increase consumption at low price periods. These policies are tightly linked with the deployment of smart grids and real-time metering. Depending on the availability of the infrastructure necessary for real-time metering, the demand-side actor can delegate load management decisions to the TSO. The system regulator might also establish specific supply side incentives for power generators to produce energy during high demand periods in addition to the higher market prices such as targeted capacity payments. Two successful examples of DSM can be found in the United States:

- The real-time price response programme at the New England ISO electricity market. This programme consists of voluntary reductions of electricity consumption when wholesale prices in a particular region are forecasted to exceed a certain price. This programme requires the installation of a special metering device to allow the operator to know the end user consumption in a real-time basis.
- ERCOT’s demand response programmes: The ERCOT market offers the Voluntary Load Response Programme that provides curtailment or reduction in response to market price or other factors using direct or indirect tools. The ERCOT market enables demand-side responses through programmes such as Load Acting as a Resource (LaaR) or Balancing Up Load (BUL) that provide balancing services to the market.

Only very small shares of DSM are currently integrated into electricity markets. By increasing DSM capacity on intraday and balancing markets, market liquidity could be increased in the last stages of the technical operation of the system (demand-offer adjustment) thus increasing openness in intraday and balancing markets. As an example, ERCOT has also programmes to integrate demand-side participation in ancillary services and balancing markets.

*Efficiency programmes* on the demand side can also contribute to moderate the peak demand of electricity through more energy-efficient equipment thus contributing to a smoother demand curve. These programmes are mainly related to the efficient use of electricity and are considered important in the context of achieving a low-carbon future. One example of this is the European objective to increase energy efficiency by 20% by 2020 as part of its 20-20-20 energy policy objectives. These programmes are known as “non-dispatchable” demand-side programmes. They have no specific time or seasonal targets to reduce consumption and are targeted at mitigating energy consumption during much of the year.

In certain visions of the future, electricity systems are even considered capable of doing away with the concept of load following (system entirely focused on demand response) and incorporating an increased degree of adaptability in the demand side by using demand-side policies and tools (see, for instance, the German energy agency Dena, 2010). The United States examples concerning DSM, however, show that investments in demand-side management only take off once markets have properly designed regulation that provides a credible long-term framework with appropriate market signals.

### 5.3 Markets for managing variability and the provision of dispatchable capacity

The interaction between variable renewable technologies and current electricity market designs to ensure long-term resource adequacy is of constant concern for national regulators and systems operators. Renewable support policies distort liberalised electricity markets, which represents a long-term challenge to guarantee system security. Renewable support policies in fact interact with different types of power markets with respect to long-term resource adequacy in different ways (Hesmondhalgh et al., 2010).

There are two principal options for such a market design, energy-only electricity markets, in which only electricity is traded, and electricity markets coupled with markets for capacity provision, so-called capacity markets. In addition, a number of specific regulatory measures can be implemented in order to improve the functioning of both designs. However, since electricity is a non-storable good with inelastic demand, energy-only markets can lead to large price swings at moments of high (or low) production of renewable energy. For instance, the European Energy Exchange Market (EEX) in 2009 saw spot prices that reached the ceiling of EUR 3 000 per MWh imposed by the operators as well as several instances of negative spot prices. Those instances pose questions of economic, social and political sustainability.

In principle, energy-only markets without any extra payments for capacity provision should be able to generate sufficient capacity investment. Promoters say that electricity markets have the capability to generate appropriate incentives for promoting adequate long-term investments through markets trading obligations over different time horizons (balancing, intraday, day-ahead and forward markets in the short and medium term). It is theoretically possible to have energy-only markets achieve economic supply and demand equilibrium if one is willing to live with a certain number of hours of supply interruptions every year during which prices would reach the opportunity cost of the marginal consumer measured in the thousands of euros per MWh. This opportunity cost of the forced disconnection of a consumer is integrated into system-wide cost-benefit calculations as the value of lost load (VOLL).

The intuition behind the concept of markets for “flexibility services” such as capacity markets, which would include storage, flexible demand as well as reserve capacity, is precisely that they allow for socially more beneficial arrangements than forced curtailment. Capacity markets could thus on the one hand remunerate customers who are willing to forego electricity consumption at moments of very high demand. On the other hand, they would also allow providers with dispatchable reserve capacity such as nuclear to gain the full social value of their contribution.

Market purists instead argue that the high prices yielded in the run-up to reaching the VOLL correctly express marginal costs of electricity generation and that the resulting new investments would stabilise the situation. In the absence of either such extreme scarcity payments or capacity payments, producers run up against the “missing money”-problem, which means that they are unable to finance their fixed costs. In practice, however, the capacity market option seems largely preferable to the VOLL option as it is far less uncertain and avoids the issue of barriers to entry – any market participant, for instance, would need to be able to play the whole merit curve, which implies a costly portfolio of means of generation – and thus persistent structural underinvestment with persistent price spikes. In the long run, the latter would create serious doubts about the viability of liberalised electricity markets. Energy-only markets, where producers decide on capacity as a function of their profit opportunities may thus not be the optimal solution.

Capacity mechanisms or capacity markets can provide more sustainable solutions, although they can be complex and require considerable up-front investments by producers, consumers, operators and regulators in terms of learning, implementation and operations. Such capacity markets are currently the most promising option to organise flexibility responses. The term “capacity” in capacity markets

relates to the fact that these markets provide incentives to operators and customers to invest up-front into dispatchable installations that can inject flexibility into the market (either on the production, trading or consumption side) to mitigate the variability of wind or solar power. Without capacity markets, the infeed of intermittent production would not be sufficient to remunerate investments due to the tendency towards lower electricity prices and the reduction of load factors, the “compression effect” (see also Chapter 4).

### **The case for capacity mechanisms to internalise system effects**

Capacity mechanisms are based on a legal obligation for operators to be able to serve their clients out of their own means (which may include storage, import contracts with interconnection capacity reservation or demand curtailing obligations) at all times. The added costs of such capacity obligations can be either recuperated through capacity payments fixed by the regulator and added to the grid tariff that is included in the final electricity price or through auctions in which the providers of dispatchable capacity offer their services to generators under capacity obligations, which subsequently include their outlays into long-term electricity prices.

From an economic perspective, ensuring long-term resource adequacy and sufficient dispatchable back-up capacity is the major challenge of introducing large amounts of variable renewables whose subsidisation distorts market signals and introduces additional challenges to ensure long-term resource adequacy and sufficient dispatchable back-up capacity. The introduction of demand-side policies via smart metering and smart grids could in principle provide the necessary tools to allow more active participation of all demand-side actors to price formation thus achieving a more efficient energy only-model (see also Section 6.1). However, in many liberalised power markets, many consumers are exposed neither directly nor indirectly to market prices, for instance due to regulated tariffs. Even reinforcing the demand-side policies previously mentioned will thus not help to stabilise prices. In addition, even under the best of circumstances, consumers will require massive incentives to forego heating, washing, cooking or watching television at the moment they originally desired.

Given the lack of cost-efficient storage, currently only sufficient amounts of dispatchable capacity can provide the required flexibility for supplying demand when neither wind or sun are available. In the face of these challenges, many electricity markets organise additional payments, often determined by regulation rather than by the market, to provide added incentives for capacity investments. These regulated extra arrangements to manage balancing markets, congestion costs or operating reserves alter the functioning and the outcome of the market process. Nevertheless, these payments are good complements to reward dispatchable power plants if these incentives are properly designed to give the right market signals to supply flexibility services.

Depending on the institutional arrangements for defining additional capacity, two subcategories of capacity markets can be distinguished: payment-based mechanisms (resource adequacy is aimed to be achieved through administratively determined capacity payments) and quantity-based mechanisms that establish precise resource adequacy obligations, usually as a function of electricity generation.

*Payment-based capacity mechanisms* allow regulators to stimulate certain levels of capacity investment. This is achieved by capacity payments that reflect the level of remuneration the regulator projects to be necessary to deliver generation reserves in the middle or long term. This model allows differentiating capacity payments from other payments (ancillary services, congestion management, etc.). It is thus the solution preferred by policy-makers and regulators. Capacity payments provide steady remuneration that decreases investor’s uncertainty by providing different services, for example “load migration” or reductions of demand in peak load moments. Nevertheless, this model poses several challenges. Fixing a given level of remuneration does not guarantee efficiency as the payment level can lead to either underinvestment or overinvestment. Furthermore, the regulators discretion to set and modify capacity payments might also increase investor uncertainty.

*Quantity-based capacity mechanisms:* Guaranteeing resource adequacy by imposing on retail suppliers the requirement to have adequate capacity to cover their commitments at all times can also ensure capacity adequacy and ensure the provision of sufficient back-up and ancillary services. If well designed, they can guarantee a certain targeted level of reliability by encouraging the most efficient way

to achieve this capacity requirement. This would correspond to proper *capacity markets*. Quantity-based capacity mechanisms, however, require special tendering and verification procedures that are complex and costly. This increased complexity could lead to inefficiencies and undesired market outcomes due to an excess in market intervention by system regulators. There is also an ongoing debate whether auctions should be held only over extreme peak-load provision, say during the 200 hours per year with the highest load, or over the whole period, that is 8 760 hours per year.

Capacity markets are not the only option to generate adequate levels of investment in low electricity systems. Below are presented two contrasting examples from key OECD countries. While the United States have mainly chosen capacity markets as their instrument of choice to ensure sufficient levels of dispatchable power, including nuclear energy, the United Kingdom is currently experimenting with a wider array of alternative instruments in order to generate sufficient levels of investment in low-carbon technologies, both dispatchable and variable ones. Again nuclear energy is one of the key options. The double focus on nuclear underlines the fact that nuclear is effectively the only major dispatchable low-carbon source of electricity that is not limited in supply.

### Experiences with capacity markets in the United States

Most power markets in the United States use different forms of mandatory capacity remuneration (see Figure 5.4). Two different capacity market models examples from the United States are used to illustrate different trends in the US capacity markets to ensure long-term resource adequacy.

The New England forward capacity market is a forward market aiming to incentivise energy generators to invest in generation capacity of the right type and in the right locations to satisfy a reliability standard at the lowest cost. The capacity market provides strong incentives for suppliers to perform when and where most needed, reduces risk for both generators and load, and addresses market power both in the capacity market and in the spot energy market. This mechanism is based on locational installed capacity (ICAP) demand curves that are more elastic than traditional demand curves and that integrate local circumstances and transmission constraints. Thus, additionally the capacity compensation based on these demand curves is responsive to local supply scarcity (Cramton and Stoft, 2005).

**Figure 5.4: Regional electricity markets in the United States with mandatory capacity markets**

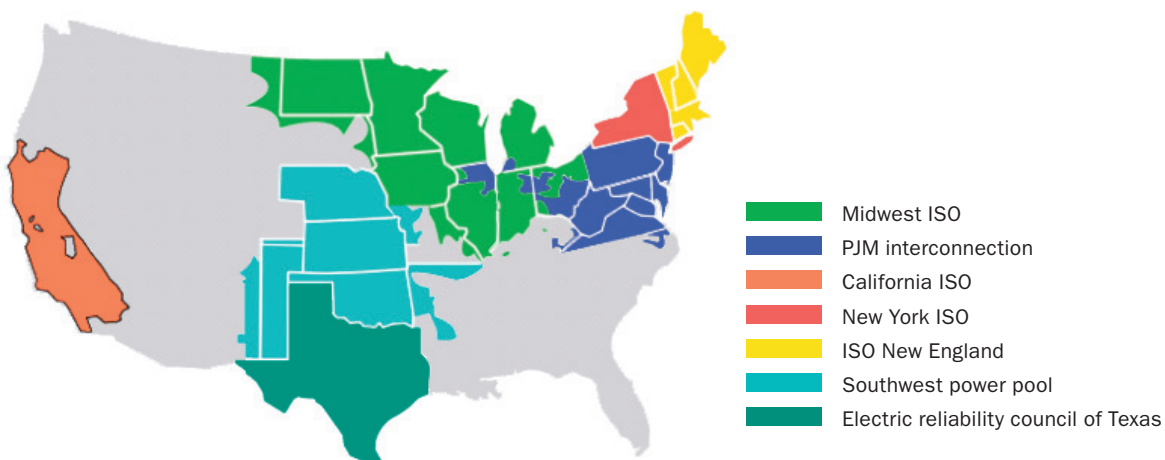

Source: Based on Hobbs, 2010.



A capacity market with a very different timing scale compared to the New England forward capacity market is the PJM (for the Pennsylvania, New Jersey and Maryland Interconnection) reliability pricing model. While the New England forward capacity market is working on a monthly scale, the PJM reliability pricing model works on a three-year timescale. The long-term perspective of the PJM includes incentives designed to stimulate investment not only in maintaining existing generation and in enforcing the development of new sources of capacity but also in capacity resources such as demand response and transmission facilities that mitigate market power. Recent reforms in the reliability pricing model of the PJM to ensure long-term resource adequacy include the use of self-supply and bilateral contracts by load-serving entities (officially registered producers) to meet their capacity obligations. The model also includes capacity auctions to obtain the required reserve capacity once market participants have committed their supply.

This mechanism has also rendered demand curves more elastic allowing the establishment of a true price of capacity depending on the costs of instantaneous capacity provision as well as on forecasted revenue streams, the interaction with other markets, forecast changes, economic fluctuations, weather conditions and risk attitudes of the different market participants. This capacity model seeks to provide long-term market signals to reflect the geographical limitations on the transmission system's ability to deliver electricity into an area and to account for the differing capacity needs in different PJM areas. This mechanism, in contrast to the New England capacity model ensures that sufficient resources will be available to preserve system reliability for a three-year time horizon (PJM, 2011).

### **Exploring other options for incentivising low-carbon capacity in the United Kingdom**

The United Kingdom is facing an important need for new installed generation capacity as by 2015, around 20 GW of existing capacity is expected to be closed. Modelling shows low capacity reserves levels by 2020, thus increasing the likelihood of blackouts. Policy-makers are concerned whether enough private investment will be raised in the coming years to ensure long-term system adequacy. The presence of a strong carbon constraint limits the extent to which CCGTs can be used as providers of flexible back-up. UK policy-makers have addressed these challenges through a broad set of policy reforms in the energy sector with the declared intention to transform the UK's electricity system to enable it to ensure a secure, low-carbon and affordable electricity supply.

The Department of Energy and Climate Change (DECC, 2011) in the *White Paper Planning our Electric Future: a White Paper for Secure, Affordable and Low-carbon Electricity* traces the key strategies to meet the following energy policy objectives:

- contracting for low-carbon generation and security of supply (in the middle and long term);
- new institutional framework and arrangements with certain and stable regulatory commitments;
- improvement of market liquidity.

While capacity markets are supposed to be part of the overall picture in some years' time, the principal measure to ensure adequate low-carbon capacity under the UK long-term regulatory frameworks for low-carbon generation are feed-in tariffs with contracts for difference (FIT CfD). In other words, nuclear, renewables and carbon capture and storage will receive a stable per MWh remuneration by adding or subtracting the difference between market prices and a preset "strike price". This supporting framework, based on already implemented quantity-based mechanisms in other countries, such as FIT premiums with caps and floors in Spain, provides stable revenues to low-carbon generators but tends to affect wholesale power markets less than other quantity-based support mechanism such as simple feed-in tariffs. In fact, the British government is concerned by the low levels of liquidity in the electricity wholesale market due to vertical integration and one aim of the Electricity Market Reform is to provide sufficient liquidity to allow all independent generators, regardless of their size, to compete effectively in the market.

UK policy-makers also plan additional incentives for investment in low-carbon technologies such as (1) a carbon price floor that further reduces uncertainty associated with carbon prices by providing a floor price to incentivise investments in low-carbon generation technologies, as well as (2) an emission performance standards (EPS), which sets a limit of 450 g CO<sub>2</sub> per kWh at baseload that new fossil-fuel power stations can emit. The latter is primarily an incentive for coal-based power producers to deploy CCS technology along with any new constructed fossil-fuel plant.

This new contracting strategy aims at ensuring long-term diversification of supply, and hence improved security, operational security and resource adequacy. In addition it is planned to create in the medium term a reliable, flexible and efficient production system by legislating for a new capacity payment mechanism. The strategy being put in place by the British government will require a new institutional framework that will need to be robust, stable and credible to be trusted by investors. If all goes well, the future UK's electricity mix will be dominated by renewables and nuclear power as well as by fossil fuel technologies with CCS. Whether capacity markets in the United States to ensure adequate levels of dispatchable power or feed-in tariffs and carbon-price floors in the United Kingdom, nuclear power is well positioned to take advantage of the need for dispatchable, low-carbon electricity in either setting.

#### **Additional measures to improve markets with large amounts of variable renewables**

The concern over how electricity markets should be structured and regulated in order to meet targets for emission reductions as well as system security and reliability is shared by the different institutional set-ups currently used across OECD. Even in the absence of low-carbon policies, there is inevitably a gap between the planned electricity production, sold on forward markets or on the day-ahead market that is based on forecast demand, and the real-time operation of the electricity system under the responsibility of the network operator that takes into account real instantaneous demand as well as the required ancillary services (compensation for network losses, for instance).

Intraday markets and balancing markets help bridge this gap in economic and operational terms. The real-time balancing market is thus a key contribution to a secure and efficient electricity supply. Low-carbon policies and specially variable and unpredictable variable renewables represent a set of challenges to the current market design since they tend to reinforce this gap, both at the operational side (real-time operation) and at the economic side (forward and day ahead markets). Regulation imposes the priority of renewable electricity production over conventional generation. This priority in network access imposes on the entire system the unpredictability and intermittency associated with the renewable energies that have the highest market penetration: wind and solar. This demands a review of current production frameworks and a market design that allows for much higher flexibility levels over all time frames of the electricity market (see below Figure 5.5).

**Figure 5.5: The dynamic dimension of market co-ordination**

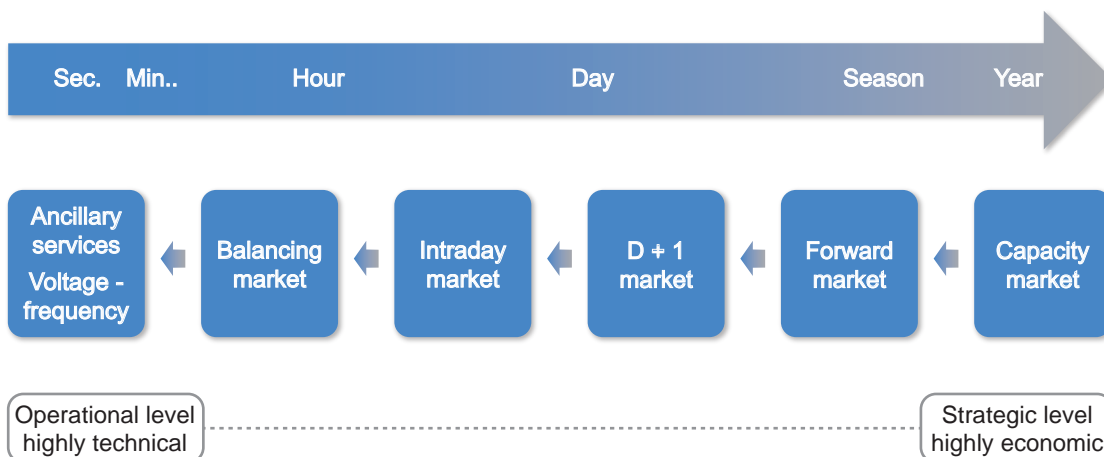

Current market designs, originally conceived for production being based wholly on dispatchable technologies, need to be reviewed to maximise market efficiency in the presence of intermittency and unpredictability. The internal functioning and relation between short-term markets (balancing, intraday for load following on a minute-scale dealing with hour-ahead forecasting), intermediate markets (day-ahead markets and forward markets for day-ahead, month-ahead and year-ahead scheduling) and long-term markets for capacity and investment must be reviewed in order to provide the highest degrees of flexibility to accommodate as efficiently as possible variable renewable technologies.

In order to achieve higher flexibility levels within current power market designs, Borggreffe and Neuhoﬀ (2011) provide a number of suggestions to decrease uncertainty and the balancing costs of variable renewables. Three main strategies can be used to reduce uncertainty related to variable renewables:

- Improve weather forecasting models to achieve higher levels of variable renewable accuracy. Link available meteorological models to reduce forecasting errors further. In Germany, the output error of the 24h-forecast for the total output of German wind production was thus reduced from 6.1% in 2007 to 5.6% in 2008 (von Roon and Wagner, 2009). However, despite this improvement, the increasing penetration of variable renewables in power systems and its related increasing uncertainty outweighed the positive impact of improved weather forecasts.
- Reduce lead-times of variable renewable forecasts in intraday market. Forecast accuracy is improved as the forecast approaches real-time operation. These improvements with respect to variable renewables should be extended to the whole of the market. Figure 5.6 shows the reduction in the forecast error for a German 100 MW wind farm as the forecast horizon decreases.
- Technological spread and geographical spread in larger production areas can reduce the uncertainty stemming from variable renewables. Geographical spread will depend on the distance between windmills and the size of the observed area. Comparing Germany and Ireland, for instance, Ireland will have higher variations of wind output than Germany as the Irish land surface is smaller than Germany's (Bach, 2010). Thus, geographical spread is less important in Ireland, which implies a greater variability of wind output.

**Figure 5.6: Forecast error for wind farms in Germany**

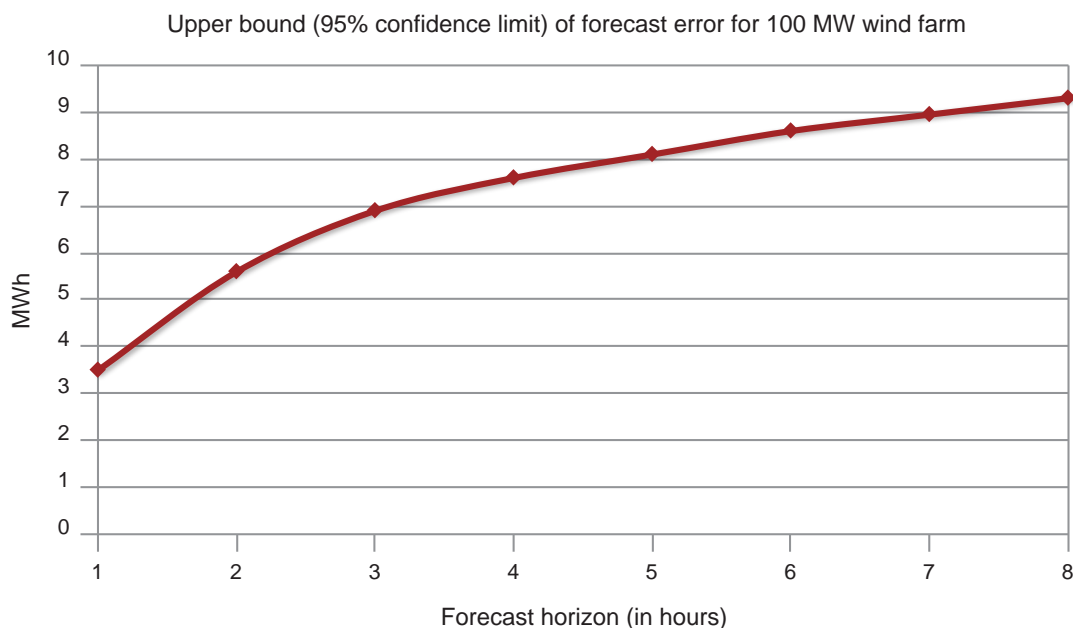

Source: Frontier Economics and Consentec, 2009.

With the introduction of the variability and uncertainty stemming from variable renewables, power markets are increasingly becoming inefficient. Originally, long-term contracting and day ahead trading were used to match the forecasted demand. Subsequently, the system operator was in charge to adjust deviations to meet real demand using the balancing market considering the real-time operation of the system. With the introduction of variable renewable uncertainty this model requires large volumes of balancing reserves contracted by the TSO at the day-ahead market. The introduction of an intraday market allows short-term adjustments to already committed capacities based on improved variable renewable forecasts and thus allows decreasing the amount of required balancing capacities (see the Spanish intraday market example in Box 5.2).

### Box 5.2

#### Regulatory innovation in Spain to integrate variable renewables

In Spain, wind producers must submit to the TSO (Red Electrica de España, REE) a production programme at the closure of the day-ahead market. Regulated penalties exist for different degrees of deviation. Throughout the intraday market, REE opens six consecutive clearing auctions that allow adjustments of power plants and optimisation of the system based on real-time information and updated forecasts. This solution, along with the introduction of a dedicated renewable energies integration management centre (CECRE), a pioneering initiative to monitor and control renewable energy resources with the objective to integrate the maximum amount of production from variable renewable energy sources under secure conditions has allowed an efficient introduction of wind power in Spain (REE, 2010). The TSO has maintained constant the required balancing capacities, despite the enormous penetration of wind power in Spain and the fact that the Iberian peninsula has limited interconnections with neighbouring countries. Spain has also developed transparent and accessible meteorological forecasts with CECRE and its advanced forecast model SIPREÓLICO (de la Fuente, 2010). A system that shares balancing responsibilities with producers will induce as well variable renewable producers to develop their own forecasting resources in order to minimise their deviations from the day-ahead forecast, i.e. internalisation of system integration costs due to unpredictability.

Most importantly, a proper and clear regulatory framework must support TSOs with intraday adjustments to balance deviations from variable renewables. All parties have to share benefits and responsibilities from system balancing and there exist nowadays a variety of power market designs allowing increased internalisation of system costs. Several key features of such improved designs are presented in the following.

*The joint provision of energy and balancing services:* In systems with low levels of variable renewables, the balance of demand and supply does not change very much between days and follows largely stable daily, weekly and seasonal patterns. Thus, energy provision and balancing services can be planned in advance by power utilities. The challenge appears within power systems with large amounts of variable renewables, especially wind. Close co-operation among energy producers and the TSO is key to minimise variable renewable integration costs. Advanced trading mechanisms allowing this are:

- Fully bilateral markets allowing energy trade and balancing services in the same platform, including a number of energy and balancing services specified by TSOs.
- Advanced trading mechanism, centralised optimised markets that promote joint trading. Power generators and TSOs submit flexible detailed bids (ramp rates, load constraints, start up costs, regulatory preferences, etc.) and real-time network information to the system operator that will calculate the optimal solution using advanced algorithms.

Advanced trading mechanisms have been widely developed in the liberalised US markets, allowing market participants to submit specific detailed bids that can be assimilated to “flexible market-based resources”. These advanced markets can also integrate international interconnections and demand-side resources to increase overall efficiency.

Any market will require the clear allocation of responsibilities. A simple obligation for producers to provide constant bands of electricity (say in 4-hour segments) rather than the freely changing load profiles of variable producers would oblige the latter to contract for the balancing services outlined above. This would *de facto* internalise the system effects related to balancing and be a first step towards a rationalisation of current electricity market arrangements.

*Market power monitoring* close to real-time trading reduces the availability of some generators to participate in the market thus increasing some other generators market power. Strict control of the bids by the system operator submitted is essential to guarantee the efficient functioning of the system and limit the exercise of market power. In order to mitigate possible market power, market regulators should enforce:

- Non-discriminatory and transparent information concerning the state of the system and information on the submitted bids available to all market participants.
- Evaluation if bid prices are appropriate. Having complex bids with different detailed parameters is also a mechanism to better assess the submitted bid. These kinds of controls can be based on an *ex ante* basis or on an *ex post* basis. Both require significant institutional capacity and regulation from independent institutions at the national or supranational level.

*Gate closure* determines the boundary between forward and intraday markets and the opening of the balancing market, i.e. the gate closure determines the moment at which power plants operators have to provide their forecasted output for a specific period of time. A gate closure that allows intraday markets to approach real-time balancing contributes to fewer imbalances and lowers variable renewable integration balancing costs in the form of back-up capacity. Improved forecasting tools can help to improve forecasted unit commitment plans of variable renewable power plants by reducing uncertainty. Gate closure is usually situated between 36 hours and 1 hour ahead of real-time operation. The prediction accuracy is improved by a factor of two when moving from a gate closure time of 36 hours ahead to 3 hours ahead (Luickx, Delarue and D’haeseleer, 2008). With the introduction of large amounts of variable renewable energies in power systems and improved forecasting tools available system operators and regulators should reconsider gate closure rules.

*Zonal pricing and nodal pricing:* North-American power markets mainly use nodal pricing that deals with intra-zonal network constraints, which means that, in principle, the production capacity is optimised with respect to the layout of the transportation network. This means that if network constraints are binding, every node can have a different locational marginal price (LMP). On the other hand, most European markets are single-priced. In this case, network constraints are not taken into account in wholesale trading. TSO has to deal with those effects and the resulting extra costs are socialised among the totality of grid users. This is not an efficient mechanism for allocating congestion costs, since it does not provide the correct signals to those plants which cause the congestion.

The emergence of the importance of congestion management and pricing in electricity markets with large integration of variable renewables reinforces the debate about the two pricing schemes and the need to translate congestion in price signals for electricity generators. High LMP indicates geographical locations where additional generation would lessen congestion and improve the overall efficiency of the system. High differences in LMP in close nodes might indeed indicate geographical locations with congested transmission lines. Nodal pricing and LMP provide signals to new power plant promoters for efficient allocation of new generation facilities and locational market signals to grid operators of congested transmission lines. LMP does not necessary need to be conceived around a “pool” system or single central buyer. In fact in US markets most transactions are bilateral after the submission of fixed or incremental power schedules to the system operator. Marginal bids set prices allowing quantities to vary at a price bilaterally cohabitating with long-term energy agreements (Neuhoff *et al.*, 2011; Lewis, 2009).

*Negative prices:* With the increasing presence of variable renewables, situations where supply (mainly from variable renewables) exceeds demand as well as a lack of storage facilities or interconnections are more frequent and some power markets have already experienced negative prices. From a macroeconomic perspective, negative prices *reduce* social welfare as it would be more efficient at these moments to curtail variable renewable production. But the policy objectives to decarbonise power systems only allow renewable curtailment in the event of security constraints. In moments of high renewable production, conventional plants will be regulated downwards to a minimum operational level. At this minimum operational level, it will be more economical for certain generators to keep their plants running for technical reasons by bidding in negative prices rather than to stop production and restarting it when prices recover. Negative prices denote that the existing price signals are not adequate to properly balance supply and demand.

In future, however, with a proactive demand side considering the deployment of smart metering and smart grids, negative prices signal consumers to *increase* their consumption. Negative prices should also be an incentive for energy storage investments, consuming electricity when supply exceeds demand and delivering it at periods of high demand. Already now, pump storage operators in Norway and Switzerland are operating at that rhythm. Negative prices also stimulate investments in more flexible power plants with improved load following capabilities.

In addition to capacity markets, which remain the key mechanism to provide flexibility services in the face of intermittent production from variable renewables, there thus exist a number of practical measures relating to better information provision and processing that can improve the working of electricity markets. Nuclear energy as a provider of dispatchable back-up capacity has a lot to gain from electricity markets that allocate the costs and benefits of electricity production at the system level in a more precise manner.

#### 5.4 Improving renewable support policies to reduce system effects

Renewables, like nuclear energy, contribute to reducing carbon emissions in the electricity system. In liberalised markets, however, their integration represents a challenge as they are not yet competitive against conventional sources of energy. A broad array of quantity- or price-based support mechanisms (IEA, 2008) have therefore been put in place in OECD countries to make renewable energies attractive for private investors by isolating the investment decisions regarding renewable energies from the conditions prevailing in electricity markets. However, not all forms of renewable policy create the same system effects and economic distortions. This section takes a look at the different existing regulatory frameworks for promoting renewable energies and their impact on the working and outcome of electricity markets.

Particularly in OECD Europe, a wide range of support schemes can be found. Despite the benefits of a more unified European support scheme that would mitigate market distortions in and across countries currently a host of national regulatory frameworks prevail (see Table 5.1 and IEA, 2008).

**Table 5.1: A detailed overview of renewable energy support instruments in the EU-27 in 2010**

	AUT	BEL	BGR	CYP	CZE	DEU	DNK	ESP	EST	FIN	FRA	GBR	GRC	HUN
FIT	X	X	X	X	X	X		X	X		X	X	X	X
Premium					X		X	X	X					
Quota obligation		X										X		
Investment grants		X		X	X					X			X	X
Tax exemptions		X						X		X		X	X	
Fiscal incentives			X			X				X				

	IRL	ITA	LTU	LUX	LVA	MLT	NLD	POL	PRT	ROU	SVN	SVK	SWE
FIT	X	X	X	X	X	X			X		X	X	
Premium							X				X		
Quota obligation		X						X		X			X
Investment grants			X	X	X	X							
Tax exemptions					X		X	X				X	X
Fiscal incentives						X	X	X			X		

Source: de Jager *et al.*, 2011.

These support mechanisms, especially FITs, the most widely used policy instrument to support renewable energies, depend on investment cost, O&M costs, efficiency indicators, lifetime of the asset, size and output of the plant as well as the future potential of the particular renewable technology. As certain technologies such as wind achieve higher levels of maturity, certain support schemes such as feed-in tariffs become less suitable. There is also a link between overall market design and renewable support schemes. In particular, these support schemes keep renewable energies to different degrees isolated from market signals. This section of the study reviews this interaction, i.e. how the different types of support schemes efficiently transfer economic and market signals in a liberalised market framework.

In the framework of the 1997 Kyoto Protocol with its objective of mitigating CO<sub>2</sub> emissions, renewable energy policies interact with other policies aiming to reduce greenhouse gas (GHG) emissions. In Europe for example, the cap-and-trade emissions trading system of the European Union, the EU ETS, cohabits with different national renewable support policies. This interaction is seen as counterproductive by certain economists as renewable support policies tend to reduce the price of carbon, thus favouring polluting technologies (Philibert, 2011). CO<sub>2</sub> cap-and-trade schemes such as the EU ETS could thus better achieve the policy objective of carbon emission reduction on their own. Specific renewable support policies might not only be redundant but will also cause higher overall costs for achieving a given emission reduction objective. In particular quantity-based mechanisms are costlier for the society than priced-based mechanisms (IEA, 2008).<sup>4</sup>

The main counter-argument in favour of specific support policies for renewables is that climate change mitigation is not the single policy objective behind renewable energy promotion. Other policy objectives may include local economic development, diversification of supply and energy security or the improvement of technologies with strong export potential. The end of the commitment period under the Kyoto Protocol at the end of 2012 might offer an opportunity to review, from an international perspective, overall climate change objectives and from a national perspective the interaction of current renewable support policies with other policy objectives such as climate policies and electricity market liberalisation.

### **Subsidising variable renewables in liberalised electricity markets**

Renewable energies fostered by specific support mechanisms impact spot market prices for electricity by shifting the supply curve to the right and thus reduce spot prices. In power markets, the supply curve is constructed by taking in increasing order the different marginal variable costs of all the units on offer during a given period of time. This supply curve is known as the merit order curve. The price for all suppliers is set by the last unit that meets demand at a particular time. This means that all generators other than the one offering the marginal unit meeting demand benefit from infra-marginal rents. The short-term marginal costs of renewables are very low, close to zero in fact, and these technologies thus enter at the lowest part of the merit order curve. With significant amounts of variable renewables on offer, the merit order curve shifts to the right and spot prices decrease (see Figure 5.7).

This effect is especially important at peak demand times when the merit order curve is especially steep. This increases benefits for consumers but reduces, for all existing capacity, the infra-marginal rents which are nevertheless necessary to pay for their fixed investment costs. Low marginal cost producers with high fixed costs such as nuclear are particularly affected, since they rely on a certain level of prices to pay back their initial capital outlays. High marginal cost producers will be the first to leave the market and are therefore affected by both a reduction on their production hours and on their infra-marginal rent. This is not a theoretical consideration but a reality in Spain and Germany, where an increasing number of gas plants are being idled due to the low utilisation rates in the wake of massive renewable production. Nuclear energy instead will usually remain in the market as its low variable costs will probably still be covered even by lower market prices.

4. Quantity-based mechanisms are quota obligations (usually by using tradable green certificates) and tendering systems. Priced-based market instruments are feed-in tariffs (FITs) and feed-in premiums (FIPs), fiscal incentives, such as carbon taxes, or investment grants.

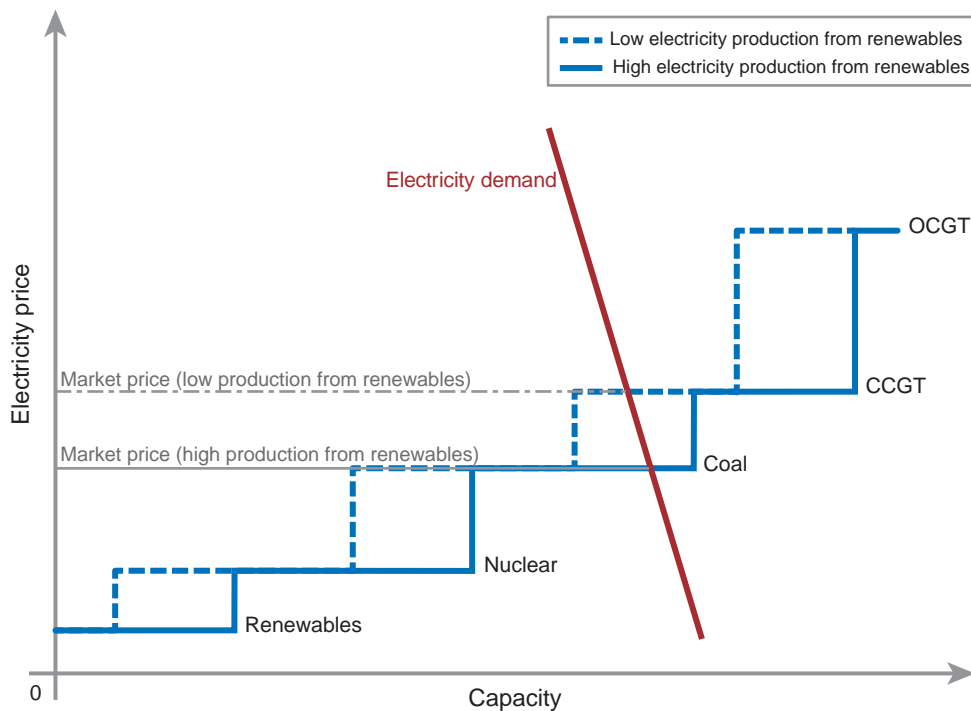
**Figure 5.7: Power spot price formation in a low wind and a high wind scenario**

On the other hand, in a long-term investment perspective gas continues to benefit from the fact that their low fixed costs provide an implicit hedge to investors, who can cut their losses and leave a market at little cost should prices prove to be too low for too long a time. Nuclear investors would have to forego the hope of ever recouping their initial outlays on the fixed costs. From an investor point of view, the advent of zero variable cost renewables thus militates against capital-intensive technologies such as nuclear.

An important problem is, however, constituted by the subsidisation of variable renewables by means of fixed feed-in tariffs or feed-in premiums. In particular, there is a distinct difference between carbon taxes and feed-in tariffs. The former, which internalise the environmental externality associated with CO<sub>2</sub> emission, provide a distinct advantage to all non-carbon emitting generators, but nevertheless provide direct market feedback to producers based on renewable energies. At negative prices, for instance, the latter would have an incentive to shut down production, rather than let customers and fellow producers scramble to find outlets for essentially worthless surplus power.

Feed-in premiums for variable renewables act to some extent like a carbon tax in reverse. While it allows also for some market feedback to renewable producers, there remain two major differences. First, they engage just like feed-in tariffs in technology picking and, selectively attributed, discriminate against low-carbon nuclear. Second, given that governments use subsidies to make renewables cheaper rather than taxes to make electricity produced by fossil fuels more expensive, the macroeconomic consequences are not the same. A carbon tax, for instance, would internalise carbon emission effects and increase overall welfare through the efficient financing of the government budget. A feed-in premium instead needs to be financed through taxes levied on other economic transactions, which reduces overall welfare, GDP and growth.

From an economic point of view, the most inefficient way to support low-carbon technologies such as wind and solar power are fixed FITs. FITs not only second-guess markets in terms of technology choices in the same way as feed-in premiums do but also isolate both long-term deployment and short-term operations from market signals. Coupled with the priority feed-in for renewables and due to their zero short-term marginal costs, wind and solar power will thus produce exclusively as a function of



meteorological conditions and completely independently of market conditions. This leads to a complete disregard for system costs and is, of course, one of the reasons for high adequacy and balancing costs. Its profits depend exclusively on the amount of MWh it produces. A wind-turbine operator will thus prefer a site with strong but variable winds with high system costs over a site with less strong but more regular winds which would have lower system costs.

The fact that variable renewables cannot easily react to market signals due to their unpredictability and variability is a common argument to justify the isolation of variable renewables from the market. But the picture has to be seen in a broader context. Taking a system-wide point of view, exposing variable renewables to market signals has a number of positive impacts (Hiroux and Saguan, 2010):

- selection of wind-power sites based on time and specific delivery periods;
- selection of wind-power sites to optimise congestion management and minimise transportation losses;
- market signals to induce more efficient maintenance planning;
- more efficient technology combinations and portfolio effects;
- curtailment in cases of imbalance, network constraints and negative prices;
- improving dispatching through innovation (incentive to internalise the costs of intermittency);
- improving variable renewable generators forecasts (incentive to internalise the costs of uncertainty).

Most importantly, renewable support schemes should take into consideration the different system costs of variable renewables relating to network expansion, balancing and back-up that have been described in the previous chapter. Obliging producers of electricity from variable renewables to provide stable bands of electricity rather than random production profiles would go a long way towards internalising, and in the process minimising, their system effects. Subsidisation could continue or even increase in order to continue renewable deployment if this corresponds to public and political preferences. Requiring more stable production profiles would, however, advance the integration of variable renewables and dispatchable electricity provision that is urgently required. In the current situation, system costs fall entirely on the producers of dispatchable electricity, which generates pressure to leave the market. But this is precisely the part of production which is needed to ensure the viability of the generation system.

### **The interaction of variable renewables and market design**

This section will look at how the three main renewable support regulatory frameworks: tradable green certificates (TGCs), FITs and feed-in premiums interact with the different elements of electricity markets such as forward markets, balancing markets, congestion pricing and network tariffs. These regulatory frameworks expose renewable energies in different ways to market signals in the different submarkets for electricity in Germany, Spain and the United Kingdom (Hiroux and Saguan, 2010; Klessmann, Nabe and Burges, 2008).

- *Feed-in tariffs* imply that producers based on variable renewables are not exposed to market signals. Renewable energy producers receive instead a guaranteed remuneration as a function of the overall energy injected into the grid, regardless of current market prices. As far as the responsibilities on the short-term balancing market are concerned, market regulators can either choose to assign all integration costs related to intermittency and unpredictability to system operators who will distribute these costs among network users. This isolates renewable energy producers from the additional costs they generate in the balancing market. Another option is to make renewable energy producers under the FITs regulatory framework take some of the balancing costs by exposing them to balancing signals. In Spain, for example, all electricity generators with an output capacity of more than 10 MW must guarantee their daily schedule 30 hours in advance; imbalances are imputed to all electricity generators regardless of their technology. Nevertheless, variable renewable producers benefit from a tolerance for deviation of 20%, while conventional producers are accorded only 5%.

- *Feed-in premiums* instead imply that variable renewable producers participate in forward and intraday-markets just as conventional electricity producers. However, in this case renewable producers receive a regulated premium over and above the hourly electricity price, the premium payment representing the presumed positive externality stemming from the use of the renewable technology. In some cases, the remuneration for renewable producers has also seen floors and caps put in place to mitigate the uncertainty resulting from variable electricity prices (such as in Spain, Royal Decree 661/2007, NREL, 2010). The market price including the premium will thus always fluctuate within a certain range, thus ensuring that generators neither suffer from electricity prices that are too low, nor earn undue windfall profits due to high electricity prices.

Renewable producers under the feed-in premium regulatory framework participate in the balancing market just as other market participants. Balancing costs are borne by renewable producers under the same terms as other market participants, although specificities in terms of tolerance values may exist (see Figure 5.8). Producers of variable renewables are thus keenly interested to reduce the unpredictability and variability of their production and to reduce balancing costs. From the point of view of minimising system costs, feed-in premiums hold definite advantages over simple feed-in tariffs.

**Figure 5.8: The provision of wind balancing services**

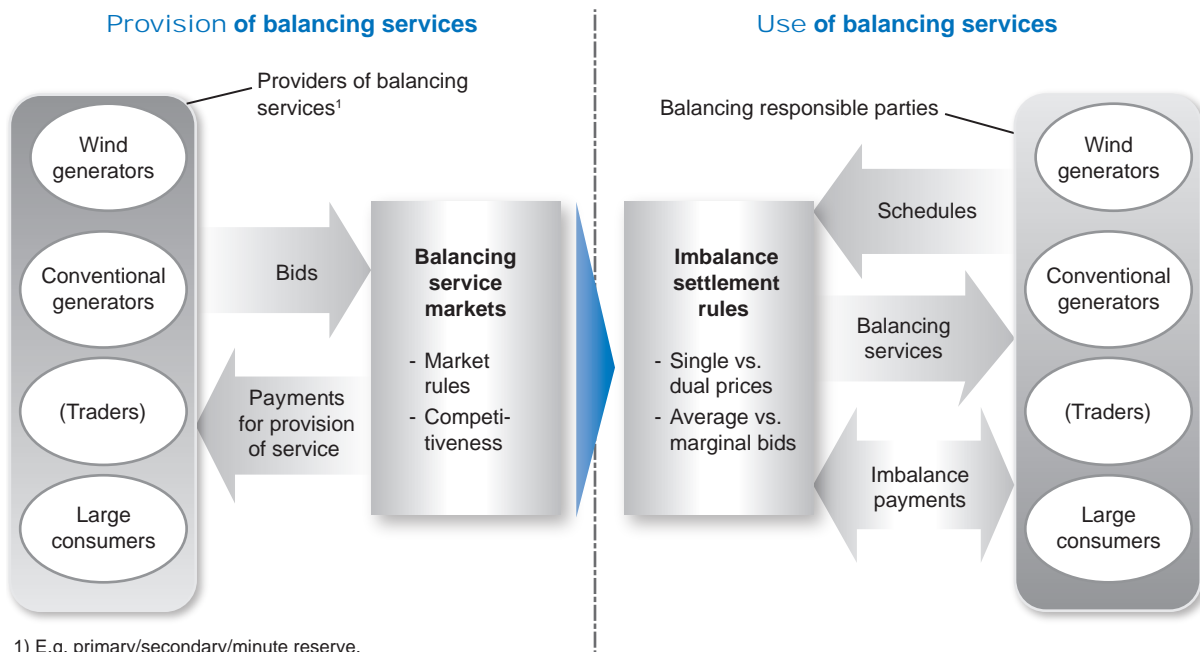

Source: Klessmann, Nabe and Burges, 2008.

This also holds for locational signals, with feed-in premiums renewable producers exposed to the same signals as other generators. Feed-in premiums thus have emerged as a promising evolution from simple FIT regulatory frameworks to solicit cost-minimising behaviour from producers based on variable renewables at the system level. As mentioned above, feed-in premiums raise the relative profitability of only certain low-carbon technologies. A carbon tax would, of course, favour *all* low-carbon technologies including nuclear energy and carbon capture and storage. From the point of view of incentivising the market to provide a least-cost solution to attain a given emission reduction objective, a carbon tax would therefore be the most economically effective solution.

*Tradable green certificates (TGC)* imply that renewable producers have the same forward and intraday market exposure as other producers. Renewable producers under TGCs are remunerated in the same way as with feed-in premiums, adding a premium to the electricity price. In this case, however, the premium corresponds to the price of traded green certificates. This premium is more volatile than regulated feed-in premiums and thus creates additional uncertainties for renewable investors.

Again, under the TGC regulatory framework renewable energies participate in the balancing market under similar exposure conditions as in the case of feed-in premiums. Specific balancing rules can also be applied with respect to wider tolerance values for renewable energy generators. The interaction of TGC and locational signals depends largely on national regulations. In principle, variable renewable generators will be exposed to the same signals as other conventional producers but specific regulation may change this. In Australia, for example, renewable producers are exposed to locational balancing market signals (mainly depending on network connections) to induce a more efficient distribution of wind outputs (MacGill, 2010).

In general, less distorting renewable policies should be promoted so that all technologies can participate in wholesale electricity markets on an equal footing. Feed-in premiums with a cap-and-floor mechanism have proven to be a support mechanism creating rather limited distortions. They also maintain a certain degree of regulatory discretion for regulators allowing them to adjust premiums and to accelerate or slow down renewable energy deployment. When coupled with a deep integration of connection costs and capacity obligations, feed-in premiums provide producers with incentive to minimise system costs while maintaining the subsidisation of renewables. The link between market design and renewable support policies on the one hand and system costs on the other is thus vital.

In order to ensure resource adequacy in the long term, appropriate markets signals should be given in order to maintain a sufficient remuneration and appropriate investment incentives for dispatchable technologies such as coal, gas and nuclear. It should nevertheless not be forgotten that a simple carbon tax has much the same economic effect as a feed-in premium, all the while providing a simple and clear signal to *all* low-carbon technologies.

## 5.5 Conclusion

The common objective of OECD countries to decarbonise electricity systems and the subsequent introduction of variable renewable energies impose different system effects due to their inherent variability and unpredictability. This requires the provision of flexibility services in order to generate continuous matching of supply and demand. Between dispatchable back-up capacity, increased interconnection capacity, storage and demand-side management, energy markets need to be enabled to find the most efficient solution to provide system flexibility and ensure second-by-second matching of supply and demand. Policy-makers, network operators and regulators therefore need to reorganise the current electricity institutional frameworks to allow selecting the most cost efficient solutions.

Balancing and capacity markets are important elements in organising this flexibility response. In the short term, however, the provision of dispatchable back-up capacity is still likely to be the most cost-effective solution. Nuclear energy plays an important part in this context as its load following capabilities are as good as those of coal-fired plants and close to those of combined cycle gas plants. In addition, nuclear energy is the only dispatchable source of electricity that remains consistent with the original intentions behind the policy decision to support renewable technologies namely to reduce climate change inducing greenhouse gas emissions and to reduce import dependency.

An important element of future regulatory policies will be the setting of appropriate capacity mechanisms, to ensure long-term system adequacy. This should sufficiently remunerate dispatchable capacity, including nuclear, to keep it attractive for investors. Virtually all major OECD countries are currently looking at different designs for capacity markets. Given the high stakes of this development for the competitiveness and profitability of nuclear energy, the NEA will continue to closely follow this development.

Short-term balancing linked to the uncertainty surrounding forecasts of renewable production can be managed via balancing markets. Obliging the producers of electricity on the basis of variable renewables to cover, wholly or partially, for the balancing costs they cause (for instance, by obliging them to commit to a certain level of injections in advance) will provide the most effective incentive to improve forecasting and reduce variability. A gradual shift from output-based to capacity-based support mechanisms would generate similar beneficial effects.

In order to deploy these tools within liberalised power systems, policy-makers and regulators need to improve current regulatory frameworks by explicitly taking system costs into account, maximising positive system effects stemming from flexibility and reducing negative system effects stemming from exogenously induced variability. Feed-in premiums instead of feed-in tariffs could go some way to improve the working of the electricity systems in OECD countries, which need to accommodate ever larger shares of variable renewables under increasingly stringent carbon constraints. Obliging producers to feed continuous bands of electricity into the system instead of variable load profiles would further allocate balancing costs to renewable producers rather than to the market at large.

Carbon pricing would induce the same effect with the added benefit of providing a general incentive for low-carbon technologies. Capacity markets will further provide regular remuneration for the provision of dispatchable capacity. As these regulatory changes come into effect in coming years, there are likely to offer some added opportunities also for nuclear power, which remains the only dispatchable low-carbon source of electricity wherever significant hydropower reserves are not available.

## References

- Bach, P.-F. (2010), *The Variability of Wind Power: Collected Papers 2009-2011*, Renewable Energy Foundation, London, United Kingdom.
- Borggrefe, F. and K. Neuhoff (2011), *Balancing and Intraday Market Design: Options for Wind Integration*, Climate Policy Initiative.
- California Energy Commission (2008), *The California Energy Commission, California Distributed Energy Resources Guide*, [www.energy.ca.gov/distgen/](http://www.energy.ca.gov/distgen/).
- California ISO (n.d.), *Locational Marginal Pricing (LMP), Overview 101*, [www.caiso.com](http://www.caiso.com).
- Capgemini (2008), *European Energy Markets Observatory 2007 and Winter 2007/2008, Data Set 10th Edition*, November 2008.
- Capgemini (2011), *European Energy Markets Observatory 2010 and Winter 2010/2011, Data Set 13th Edition*, October 2011.
- Cramton, P. and S. Stoft (2005), "A Capacity Market that Makes Sense", *Electricity Journal*, 18, pp. 43-54.
- de Jager et al., 2011 (2011), *Financing Renewable Energy in the European Energy Market*, Project number: PECPNL084659, Ecofys, Berlin, Germany, ordered by European Commission, DG Energy, Brussels, Belgium.
- de la Fuente, I. (2010), *Ancillary Services in Spain: Dealing with High Penetration of RES*, Red Eléctrica de España, Madrid, Spain.
- de Vos, K., P.S. Perez and J. Driesen (2010), "The Participation in Ancillary Services by High Capacity Wind Power Plants: Reserve Power", University of Leuven (K.U. Leuven), ESAT, Leuven, Belgium. [www.esat.kuleuven.be/electa/publications/fulltexts/pub\\_1970.pdf](http://www.esat.kuleuven.be/electa/publications/fulltexts/pub_1970.pdf).
- DECC (2011), *Planning our Electric Future: a White Paper for Secure, Affordable and Low-carbon Electricity*, Department of Energy and Climate Change, London, United Kingdom.
- Delarue, E. et al. (2011), "Balancing Demand and Supply on Electric Power Systems with a Large Share of Renewable", University of Leuven (K.U. Leuven), Energy Institute, Leuven, Belgium.
- Dena (2010), "Integration of Renewable Energy Sources in the German Power Supply System from 2015-2020", Dena Grid Study II, Deutsche Energie-Agentur (Dena), November, Berlin, Germany.
- ECOFYS (2008), *Perspectives of Innovative Technologies for Integrating Renewable Energies, European Sustainable Energy Week (EUSEW2008)*, 1<sup>st</sup> February, Berlin, Germany, [www.erneuerbare-energien.de/files/pdfs/allgemein/application/pdf/eusew\\_slides\\_ecofys.pdf](http://www.erneuerbare-energien.de/files/pdfs/allgemein/application/pdf/eusew_slides_ecofys.pdf).
- EURELECTRIC (2004), *Ancillary Services – Unbundling Electricity Products – an Emerging Market*, Union of the Electricity Industry – EURELECTRIC, Brussels, Belgium.
- EURELECTRIC (2010), *Integrating Intermittent Renewables Sources into the EU Electricity System by 2020: Challenges and Solutions*, Union of the Electricity Industry, EURELECTRIC, Brussels, Belgium.
- EC (2005), *Towards Smart Power Networks – Lessons Learned from European Research FP5 Projects*, [http://ec.europa.eu/research/energy/pdf/towards\\_smartpower\\_en.pdf](http://ec.europa.eu/research/energy/pdf/towards_smartpower_en.pdf).
- EC (2011), *Energy Infrastructure Priorities for 2020 and Beyond – A Blueprint for an Integrated European Energy Network*, European Commission, Luxembourg.
- EC JRC (2010), *Towards the Super Grid for More Renewable Energy*, European Commission, Brussels, Belgium, [http://ec.europa.eu/dgs/jrc/downloads/20100705\\_jrc\\_esof\\_press\\_info\\_grids.pdf](http://ec.europa.eu/dgs/jrc/downloads/20100705_jrc_esof_press_info_grids.pdf).
- EC SETIS (n.d.), *Electricity Storage in the Power Sector*, European Commission, Strategic Energy Technologies Information System (SETIS), <http://setis.ec.europa.eu/newsroom-items-folder/electricity-storage-in-the-power-sector>.

- FINGRID (2011), *Key Challenges in Transmission Network Capacity in Finland*, presentation by Jussi Jyrinsalo, WPNE International Workshop on System Effects, 24 May 2011, NEA Headquarters, Issy-les-Moulineaux, France.
- Frontier Economics and Consentec (2009), *Blowing in the Wind – Measuring and Managing the Costs of Renewable Generation in Europe*, Frontier Economics Ltd., London, United Kingdom.
- GWEC, Greenpeace, World Power Work (2008), *Global Wind Energy Outlook 2008*, Global Wind Energy Council, Greenpeace and World Power Works, Brussels, Belgium, [www.gwec.net/fileadmin/documents/Publications/GWEO\\_2008\\_final.pdf](http://www.gwec.net/fileadmin/documents/Publications/GWEO_2008_final.pdf).
- Hesmondhalgh, S., J. Pfeifenberger and D. Robinson (2010), *Resource Adequacy and Renewable Energy in Competitive Wholesale Electricity Markets*, The Brattle Group, Inc., Washington, D.C., United States.
- Hiroux, C. and M. Saguan (2010), “Large-scale Wind Power in European Electricity Markets: Time for Revisiting Support Schemes and Market Designs?”, *Energy Policy*, Vol. 38, Issue 7, pp. 3135-3145.
- Hobbs, B. (2010), *Capacity Markets: Principles and What’s Happening in the US*, European Electricity Workshop, Berlin, Germany.
- Holttinen, H. (2007), “State-of-the-art of Design and Operation of Power Systems with Large Amounts of Wind Power – Summary of IEA Wind Collaboration”, IEA WIND Task 25: Design and operation of power systems with large amounts of wind power, [www.ieawind.org/AnnexXXV/Meetings/Milan/EWEC2007%20IEATask%2025%20SessionSlides\\_final.pdf](http://www.ieawind.org/AnnexXXV/Meetings/Milan/EWEC2007%20IEATask%2025%20SessionSlides_final.pdf).
- Holttinen, H., P. Meibom, A. Orths, F. van Hulle, B. Lange, M., O’Malley et al. (2009), *Design and Operation of Power Systems with Large Amounts of Wind Power, Final Report*, IEA WIND Task 25, VTT Technical Research Centre of Finland, Finland.
- IEA (2008), *Deploying Renewables – Principle for Effective Policies*, International Energy Agency, OECD, Paris, France.
- IEA (2011), *Harnessing Variable Renewables: A Guide to the Balancing Challenge*, International Energy Agency, OECD, Paris, France.
- Klessmann, C., C. Nabe and K. Burges (2008), “Pros and Cons of Exposing Renewables to Electricity Market Risks – A Comparison of the Market Integration Approaches in Germany, Spain, and the UK”, *Energy Policy*, Vol. 36, No. 10, pp. 3646-3661.
- Lewis, G.M. (2009), “Estimating the Value of Wind Energy Using Electricity Locational Marginal Price”, *Energy Policy*, Vol. 38, No. 7, pp. 3221-3231.
- Loisel, R., A. Mercier, C. Gatzen, N. Elms and H. Petric (2010), “Valuation Framework for Large Scale Electricity Storage in a Case with Wind Curtailment”, *Energy Policy*, Vol. 38, No. 11, pp. 7323-7337.
- Luickx, P., E. Delarue and W. D’haeseleer (2008), *Considerations on the Backup of Wind Power: Operational Backup*, Division of Applied Mechanics and Energy Conversion, University of Leuven (K.U. Leuven), Leuven, Belgium.
- Mabel, M., R. Raj and E. Fernandez (2010), “Analysis on Reliability Aspects of Wind Power”, *Renewable and Sustainable Energy Reviews*, pp. 1210-1216.
- MacGill, I. (2010), “Electricity Market Design for Facilitating the Integration of Wind Energy: Experience and Prospects with the Australian National Electricity Market”, *Energy Policy*, Vol. 38, 7, pp. 3180-3191.
- NEA (2011), *Technical and Economic Aspects of Load Following with Nuclear Power Plants*, Nuclear Energy Agency, OECD, Paris, France.
- NERC (2009), *Accommodating High Levels of Variable Generation*, North American Electric Reliability Corporation, Princeton, NJ, United States.
- Neuhoff, K., B.F. Hobbs and D. Newbery (2011), *Congestion Management in European Power Networks: Criteria to Assess the Available Options*, Climate Policy Initiative, San Francisco, United States.

- NordPool Spot (2011), “Nordic Power Market”, *The Nordic Model – Explicit and Implicit Capacity Auctions – Market Coupling and Market Splitting*, [www.nordpoolspot.com](http://www.nordpoolspot.com).
- NREL (2010), *A Policymaker’s Guide to Feed-in Tariff Policy Design*, National Renewable Energy Laboratory, Washington, D.C., United States.
- NREL (2011), *Eastern Wind Integration and Transmission Study, Executive Summary and Project Overview*, EnerNex Corporation, National Renewable Energy Laboratory, Colorado, United States.
- Nyamdash, B., E. Denny and M. O’Malley (2010), “The Viability of Balancing Wind Generation with Large Scale Energy Storage”, *Energy Policy*, Volume 38, Issue 11, pp. 7200-7208.
- Philibert, C. (2011), *Interactions of Policies for Renewable Energy and Climate*, International Energy Agency, OECD, Paris, France.
- PJM (2011), *PJM – Reliability Pricing Model*, <http://pjm.com/markets-and-operations/rpm.aspx>.
- Redpoint Energy (2010), *Electricity Market Reform Analysis of Policy Options*, Redpoint Energy in association with Trilemma UK, London, United Kingdom.
- REE (2010), *Renewable Energies – Wind Power Generation in Real Time*, Red Eléctrica de España, Madrid, Spain, [www.ree.es/ingles/operacion/regimen\\_especial.asp](http://www.ree.es/ingles/operacion/regimen_especial.asp).
- Sandu-Loisel, R. (2011), *International Strategies on Energy Storage – An outlook of European Union’s strategy*, European Commission, DG Joint Research Centre (JRC) and Energy Storage Opportunities and Issues (IEA), Brussels, Belgium, [www.jrc.ec.europa.eu](http://www.jrc.ec.europa.eu).
- Stoddard, R. (2009), *Comparing Capacity Market and Payment Designs for Ensuring Supply Adequacy*, Hawaii International conference on System Sciences, pp. 1-17.
- Traber, T. and C. Kemfert (2009), “Impacts of the German Support for Renewable Energy on Electricity Prices, Emissions and Firms”, *The Energy Journal*, Vol. 30, No. 3, pp. 155-178.
- Vandezande, L., L. Meeus, R. Belmans, M. Saguan and J.-M. Glachand (2010), “Well-functioning Balancing Markets: A Prerequisite for Wind Power Integration”, *Energy Policy*, Vol. 38, 7, pp. 3146-3154.
- von Roon, S. and U. Wagner (2009), “The Interaction of Conventional Power Production and Renewable Power under the Aspect of Balancing Forecast Errors”, *Proceedings, 10<sup>th</sup> IAEE European Conference 2009*, Vienna, Austria.
- Weigt, H., T.F.L. Jeske and C. von Hirschhausen (2010), “Take the Long Way Down: Integration of Large-scale North Sea Wind using HVDC Transmission”, *Energy Policy*, Vol. 38, 7, pp. 3164-3173.





## Chapter 6

# Future visions

The interaction of nuclear energy with intermittent renewables in decarbonising electricity systems is a relatively new phenomenon. While its qualitative implications are progressively becoming clearer, the precise contours of this interaction are still unknown given that the interaction takes place in a context of rapid structural and technological change. In principle, this study approaches the interaction of nuclear energy and renewables from a point of view that considers structures and technologies that are currently known. However, this does not exclude an awareness that this interaction may be shaped in the coming years and decades by new developments in yet unforeseen ways.

The OECD/NEA Working Party on Nuclear Energy Economics (WPNE) decided to study two of such possible but not yet entirely understood phenomena in greater depth: the impact of smart grids in facilitating the interaction of nuclear energy and intermittent renewables, and the possible role of small modular reactors (SMRs) in reducing the system costs of nuclear power by offering greater modularity and flexibility. Each of the two sections provides a brief scoping study rather than a systematic treatment of the two possible technological developments, which are likely to have significant impacts on the system cost issue, one way or another.

### 6.1 The role of smart electricity grids in facilitating the interaction between intermittent renewables and nuclear power in integrated electricity systems<sup>1</sup>

The concept of “smart” or “intelligent” electricity grids has been around for some time. However only recently have smart grids received such a high degree of attention, driven by progress in information technology, heightened regulatory focus and better informed consumers as well as an increasing need for flexibility due to significant amounts of variable renewables. In parallel, a number of improvements have taken place in network infrastructure, operations and regulation, which together are likely to have a significant impact on the operation of the different parts of the electricity system (generation, trading, transmission and consumption). The purpose of this study is to provide an overview of the likely trajectories of the evolution of the electricity grid, its design, operation and regulation and to sketch a vision of how integrated electricity systems based on such “smart” grids may evolve by 2020 and beyond.

With respect to nuclear energy, a pervasive deployment of smart electricity grids might lead to two very different outcomes. One the one hand, smart grids favour nuclear energy by smoothing load curves and providing added opportunities for large baseload providers such as nuclear. The latter are faced with the risk that a high share of variable renewables such as wind and solar significantly reduces the number of hours during which a given demand is guaranteed (compression effect). This can lead to a number of operating hours for baseload technologies that is too low to repay fixed costs. The role of smart grids in this case would be to re-shape the residual demand curve. Through demand response, load shifting and integration of storage applications, smart grids might change the load curve and re-establish a continuous demand for longer periods of time. This way, a minimum demand over a sufficiently high number of hours could be achieved, resulting in a role for (nuclear) baseload even in systems with a strong penetration of renewable energy sources.

1. This section is based on the study “Smart Electricity Grids” by Dirk Van Hertem, Erik Delarue, Leen Vandezande, Benjamin Dupont, Frederik Geth, Jeroen Büscher, William D’haeseleer and Ronnie Belmans of the Energy Institute of K.U. Leuven (Belgium), prepared as a contribution to the work of the WPNE.

On the other hand, smart grids may enable decentralised production from smaller units where demand-supply balancing is performed on a more local scale and thus restrict the demand for large baseload units such as nuclear. A more decentralised electricity system based on local energy sources could allow under certain conditions, such as the local matching of demand and supply, for shorter electricity transport distances and thus reduce electricity transmission losses. In such a setting, nuclear power plants could only be used in economically less attractive load following modes as part of the so-called local virtual power plants (VPP).

## Smart grids explained

### Background

A large number of studies have recently been published on the issue of smart grids, especially in Europe, focusing on the full or partial decarbonisation of power systems by 2050 (see ECF, 2010, EURELECTRIC, 2010, EREC, 2010, IEA, 2010a and others). In this context both renewables and nuclear power will play a role, which means that the supply-demand balancing becomes a crucial issue (D'haeseleer, 2011). Here, smart grids are an important moderator between different technologies, which can enable the operation of a diversified power system with a variety of power sources including nuclear power.

In the past, the electricity industry was organised as vertically integrated monopolies that were sometimes also state-owned. The growing ideological and political disaffection with vertically integrated monopolies and the liberalisation successes in other network industries have led to liberalisation initiatives worldwide in the electricity industry. Integrated utilities have been vertically separated or unbundled and barriers for companies to enter into generation were removed in order to increase the competitiveness of the electricity industry (Meeus, 2005).

While the vertically integrated system predominantly depended on long-term planning, the liberalised market encourages a more dynamic market mechanism, with more and competing players. The influx of large shares of variable renewables is currently leading to additional technological and commercial impacts on a massive scale. Liberalisation thus created a new marketplace, with new stakeholders, products and services and flexibility to cover the variations in generation and load has become an important aspect in the new energy market. The future energy mix will consist of a mix of traditional generation, new developments within traditional generation (e.g. flexible nuclear power plants, coal-fired plants with carbon capture and storage), renewable energy sources (both dispatchable and non-dispatchable), energy storage (possibly in the form of electrical vehicles) and more flexible demand.

The need for a smarter energy transmission and distribution system is also due to the fact that the transmission systems are operated ever closer to the system limits and because new grid investments are needed. This is caused by the growth of the use of electrical energy on the one hand and the ageing transmission systems on the other. The problem of the ageing of the transmission system presents itself most clearly in OECD countries, where large parts of the system have been constructed between the 1960s and 1980s. As such, large parts of the system are now nearing their end of life and require new investments (Figure 6.1).

In the last few decades, information and communication technologies (ICT) have also made enormous progress. Driven by the increase in computational speed predicted by “Moore’s law”, ICT applications have become commonly available. What required a supercomputer 30 years ago can now be performed on an off-the-shelf smart-phone with a user-friendly interface. Also telecommunications has made great advances, partly through the development of the Internet. High-bandwidth and high-reliability communication is now possible either point to point or point to multipoint.

Until now, the power sector has not followed these evolutions to its full extent. Although the sector was at the forefront of the technological innovations in computer science during the 1960s and 1970s, the sector has failed to keep up with innovation. The main reason for this is that the system as developed earlier worked well without an actual need to use the most advanced functionality or tools (“if it isn’t broken, don’t fix it”).

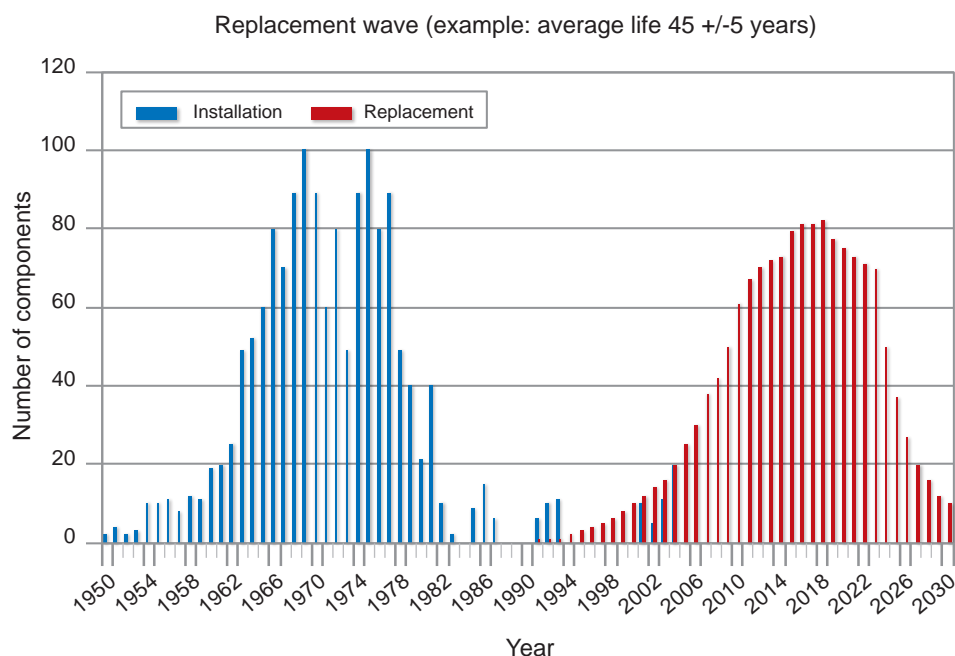
**Figure 6.1: Installation of distribution assets over time**

Note: Historic and future expected investments of a typical Dutch DSO.

Source: Gaul *et al.*, 2005 and Jongepier, 2007.

### *Functions and characteristics of smart grids*

Higher shares of renewables, more variable energy flows, new structures of the energy landscape and the expectation of constant availability of electrical energy in combination with the availability of fundamentally more powerful tools than previously available led to the development of the smart grid concept. Specifically, smart grids require the integration of communication and ICT technologies into the operation and control of the power system, and this at every level of the energy chain, from (distributed) energy sources to the home.

It is important to note that the smart grid is no simple addition of the “old” electric power system with a new layer of existing ICT knowledge. Completely new approaches are required, where both aspects are jointly integrated into one system. Compared to the old power system, the “smart grid” utilises the available ICT infrastructure to provide an optimised control of the grid. As such it consists of three important parts: measuring, optimising and controlling the system. First, sufficient measurements throughout the system are needed to become aware of the current state of the system. Smart meters allow remote reading of the actual state of the system. On the transmission level, phasor measurement units (PMUs) use the clock of the global positioning system (GPS) to accurately register the phase angle between different buses in the system.

The second aspect which is crucial to the smart grid is the use all measured data in an optimised way. This is usually done in an energy management system (EMS). The optimisation requires an in-depth understanding of the system behaviour. The following simple example explains this: When at a given point in time a storage device which is used for maximising the profits is 50% loaded, three potential decisions can be made: charge the storage, discharge the storage or keep the current loading. The decision depends on the current price of electricity, the capabilities of the storage device, the state of the other components in the system and the price forecasts for the time to come. Managing involves potentially complex data processing (e.g. taking into account one smart meter per house) and extensive data storage.

The third aspect is the actual operation based on the results from the optimisation. This operation is preferably fully automated. The optimisation objective is determined by the end user, based on internal and external data. In order to achieve this, the control centre or EMS must be able to operate the necessary switches and controls in the power system. This requires intelligent electronic devices and a bidirectional communication.

“Smart grid” is a relatively new term which represents the ambition of the electric power industry to fundamentally alter the way power systems are operated. The smart grid is using state-of-the-art information and communication technology and improved management of the energy system. Many different definitions of, and approaches to, smart grids exist. A commonly used definition is given by the Smart Grids European Technology Platform (EC, 2006; EC, 2007; EC, 2010):

“A smart grid is an electricity network that can intelligently integrate the actions of all users connected to it – generators, consumers and those that do both – in order to efficiently deliver sustainable, economic and secure energy supplies.”

A smart grid is more a vision than a concrete set of implementable elements which should be completed in the near future. Seven characteristics of such a smart grid are defined by the US Department of Energy and the Smart Grids European Technology Platform to make this vision more concrete:

- enable informed customer participation;
- accommodate all generation and storage options;
- sell more than kWh;
- provide power quality for the 21<sup>st</sup> century;
- optimise assets and operate efficiently;
- operate resiliently to disturbances, attacks and natural disasters;
- enable fundamental changes in transport and buildings.

It is quite obvious from this ambitious list that smart grids have the potential to transform current electricity grids profoundly. If they want to continue to prosper, nuclear power operators will need to prepare for the coming changes, in particular increased customer participation, in their future commercial strategies.

### *The investment challenge*

The International Energy Agency estimates that the investment needs in the European distribution network will amount to EUR 480 billion up to 2035.<sup>2</sup> Pike Research published a study where they concluded that the worldwide smart grid investments would yield a cumulative spending of USD 200 billion by 2015 (Pike Research, 2009). While they estimate that the first investments would mostly include smart metering, the major part of the investments by 2030 (84%) would be related to grid automation.

Clearly, investments are driven by a return on investment from the investors. This return on investment depends on how the grid and its components are operated and by whom. This also has consequences for the business models that are employed. As such a potential hurdle in the smart grid developments is related to the ownership, costs and remuneration. For this, a clear regulation needs to be set up by the regulating authorities.

Although many smart grid projects exist, it is extremely difficult to assign a generalised cost-benefit number on “smart grids”. This depends largely on the actual grid and available resources and the technologies implemented. In any case, a smart grid is only “smart” if it results in a cost-effective solution for the services offered. A problem might arise to correctly quantify some of the advantages. The question regarding costs and remuneration is especially difficult in view of the multiple stakeholders that may benefit from the advantages of a more intelligent grid. It might not be so easy to indicate who will need to contribute to the investments in smart grids, and who will (be allowed to) benefit from them. Allocation of the costs and net benefits (see Figure 6.2) will be an important issue.

2. Projected investment of USD 655 billion in the EU-27 distribution network according to the New Policies Scenario of the IEA (2010b).

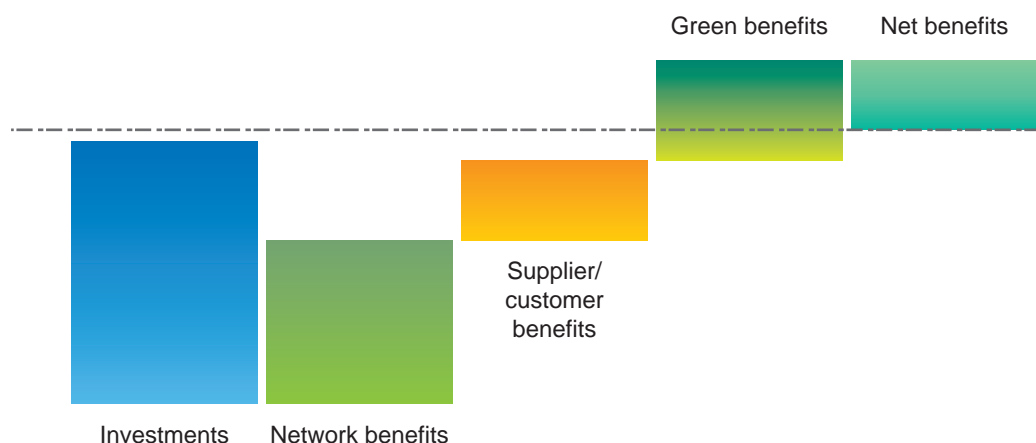
**Figure 6.2: Smart grids bring benefits to all actors along the electricity value chain**

Source: EURELECTRIC, 2011.

Regarding ownership, similar problems can be expected. An example is the ownership of smart meters: Do they belong to the grid owner, the retailer or the user? Who owns the data that these smart meters measure? In the case the TSOs are not the owner of the smart meters, will they be allowed to use the data to increase the reliability in the system, and if so, at what cost? It is clear that the answer to these questions will greatly influence the business case of many of the stakeholders. A consistent regulatory environment with clear rules is key.

In order for the smart grid to be a success or even possible, adequate regulation must be in place. This regulation should take into account that the costs for grid operation are likely to increase. With the increase of distributed generation, demand response and large scale renewable energy sources, the grid investment and operation costs will raise. Furthermore, there is no incentive for grid companies to invest in the system if there is no fair remuneration in place. While a considerable part of the investments are grid-related business, the benefits might actually be with other stakeholders. At the same time, the integration of more distributed generation and the results of demand response may reduce the transmitted energy which might actually reduce the revenues of the grid company. While the costs are increasing and the profits might be reducing, the incentives to act upon the changes are still lacking. There is a need to introduce further, yet fair, incentives to both the grid companies and the grid users (Meeus et al., 2011). In order to achieve a smarter grid, the regulatory framework should recognise the new grid service requirements and their respective costs. It should also address grid innovation technology directly (Meeus et al., 2011).

#### *How smart grids provide flexibility through demand response*

By far the most important contribution of smart grids is their potential in organising the necessary flexibility in the face of load changes due to the variability of certain renewable energies. The intermittency of wind speed, for instance, is assumed to stretch from multiple minutes to the variations on a timescale of several hours. Variability of wind power exists on the longer term as well and is driven by seasonal meteorological parameters and inter-annual variations of wind. Parameters such as wind direction and speed are season-dependent. For example, in Europe, the peaks in average available capacity of wind farms are typically situated in winter. These longer term variations are of less importance for the daily operation and management of the grid, but do play a role in strategic system planning.

Solar PV faces similar intermittency characteristics, even if solar radiation is characterised by a clear day-night profile, and faces strong seasonal patterns. Cloud cover can cause a highly variable and unpredictable output profile. When a high penetration of both wind and solar is found, as in Germany, the variations of solar power output show up to be more critical than those of wind.

Smart grids come in when the capacity for flexibility on the supply side has been exhausted and demand-side management or storage is required. In fact, demand-side responses are profitable whenever continuous generation is economically attractive. As such, it is no coincidence that the issue of demand-side management gained prominence for the first time in the 1970s and 1980s, during the large expansion of nuclear power to use the surplus of power available at night by using time of use tariff scheme. Some of the ideas of that era are actually still relevant when looking at power systems with a high level of intermittent renewables.

Demand is traditionally seen as an autonomous factor that changes over time only due to seasonal or daily behavioural patterns due to very low short-term elasticities. However, this is not necessarily so. Smart grids can activate the demand side. The energy supply can be more efficient and economic when the consumption profile can be kept constant. This will avoid using peak generation plants for short durations. This is done by encouraging the use of electrical energy during periods of low demand and as such shifting the load from peak hours to off-peak hours. This practice is called demand response (DR), load-shifting or also valley-filling, and is part of the broader term DSM which stands for the optimisation of energy consumption at the customer side.

Valley-filling flattens the net load curve (i.e. original demand minus non-dispatchable renewable generation) and yields a higher share of baseload power, which could be provided by nuclear power plants. As an example, Figure 6.3 provides a graphical presentation of load-filling with the help of demand shifting.

**Figure 6.3: The principle of peak-shaving to avoid high generating costs**

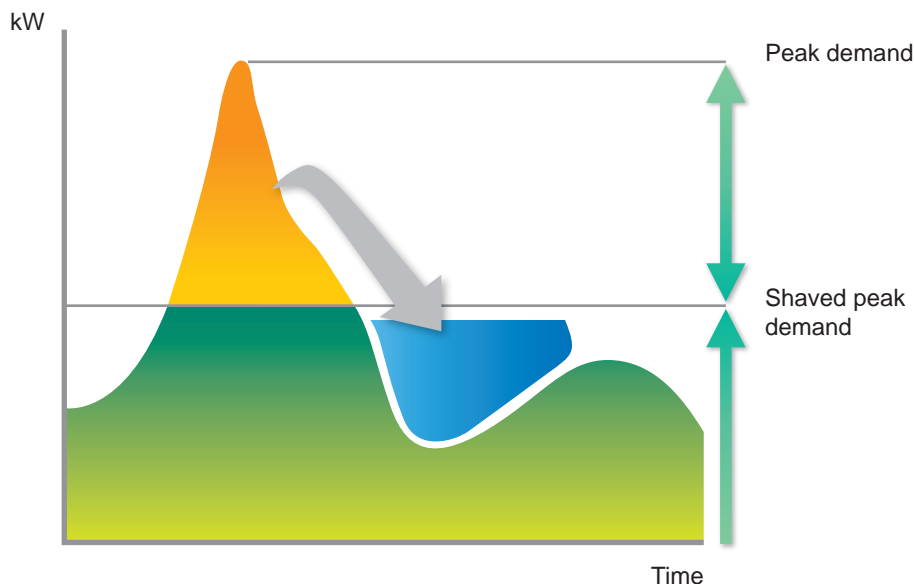

Many appliances can be used for valley-filling as well as for short-term dispatch to provide additional support to the grid. This has been in use already for quite a while on a larger scale, where large industrial plants can reduce consumption for a certain time period. With the advent of the smart grid, it will be possible to do the same thing on a much larger scale. Depending on the application, it can be acceptable to delay consumption for a shorter or longer time period. An example that is often used is the refrigerator which operates with a duty cycle to cool down (e.g. 1/3<sup>rd</sup> cool down period, 2/3<sup>rd</sup> warming period). These devices can delay their consumption (the cool down period) for a short while as long as the internal temperature remains within certain bounds. The use of demand flexibility by controlling loads also requires customer acceptance and approval. Among the options are the following.

*Short term (over the range of minutes)*

- *Refrigerators and freezers* can delay their consumption for a limited time. For refrigerators the delays can be up to 15 minutes, for freezers this can be considerably longer if the devices would allow deeper cooling and bigger temperature differences within the freezer (Vande Meerssche et al., n.d.).
- *Air-conditioners* can delay consumption in a similar manner as refrigerators and freezers. Depending on the temperature difference that is allowed, longer time periods can be achieved.
- *Ventilation systems* in houses are easy to use for shorter time periods, even though they are not present in all houses and consume a rather modest amount of energy.
- *Laptop batteries* have a typical charging rate in the vicinity of 100 W and an operating power well below that value. For short-term energy services, it is possible to switch these devices to “battery mode”.

*Long term (over the range of hours)*

- *Electric boilers* are quite widespread and have a large potential for DSM. The power rating of a typical boiler lies between 2 and 6 kW. With sufficient insulation of the boiler, the loads can be shifted for sufficient time to also use this application for valley-filling.
- *Electric heating* is also a clear candidate for demand response. The potential exists to use the electric heating system (e.g. heat pumps) in combination with a hot water tank, making the device more flexible.
- *Laptop batteries* and other electronics equipment can be used to discharge their battery while connected to the grid in the case of high energy prices. Up to several hours are achievable.
- *Dishwasher (and dryer and washing machine)* do not have a buffer capacity, but can use a delayed start, e.g. during the night instead of right after dinner.

In practice the employment of these options will need to weigh a moderate loss in consumer utility against the efficiency gains at the level of the electricity systems and the concomitant reduction in electricity bills.

*Energy storage and electric vehicles*

Electrical storage would be a natural candidate to complement flexibility provision through flexible back-up and demand-side management co-ordinated by smart grids. However, electrical energy is notoriously difficult to store and currently still suffers from very high costs. Nevertheless, a number of different technologies are available to provide storage in the grid. Electrical energy can be directly stored without conversion to another carrier in electrical double layer capacitors (EDLC) or superconducting magnetic energy storage systems (SMES). The electrical energy can also be stored through conversion, e.g. mechanical conversion in flywheels, pumped storage and CAES, thermal energy (in salt, ice, water...) or chemical conversion in fuel cells, batteries and flow batteries.

A number of parameters determine the application of these different technologies: for example efficiency, durability, bulkiness and cost (some cost estimates are given in Figure 6.4). The efficiency encompasses for example the charging efficiency and the self-discharge rate, durability includes cycle-life, shelf-life, and robustness against misuse. Among them, battery storage systems are popular and are found with a wide range of chemistries. Due to these different chemistries, the efficiency, durability, bulkiness and cost of batteries vary a lot. Batteries can be further categorised in normal (atmospheric temperature) batteries, e.g. lead-acid (Pb-acid), lithium-ion (Li-ion), nickel metal hydride (NiMH); high temperature batteries, e.g. Na-NiCl<sub>2</sub> or NaS; and flow batteries, e.g. polysulfurs sodium bromide (PSB), vanadium redox battery (VRB), or zinc-bromine (ZnBr).

Batteries, high temperature batteries, flow batteries, CAES and pumped storage are fit for long-term electricity storage. Pumped storage can function as even longer term energy storage system (ESS) if two large enough water storage reservoirs are available. Flow batteries can technically also be used for much longer-term storage due to the very low rate of parasitic reactions as the active chemicals are stored outside of the cells. For normal batteries, a very promising technology is the lithium-based chemistry. Different cathode and anode materials can be used for these cells which allows for designing a wide range of differently behaving cells. There are high energy density types, e.g. LiCoO<sub>2</sub>, as well as high power density types, e.g. Li-titanate, available.

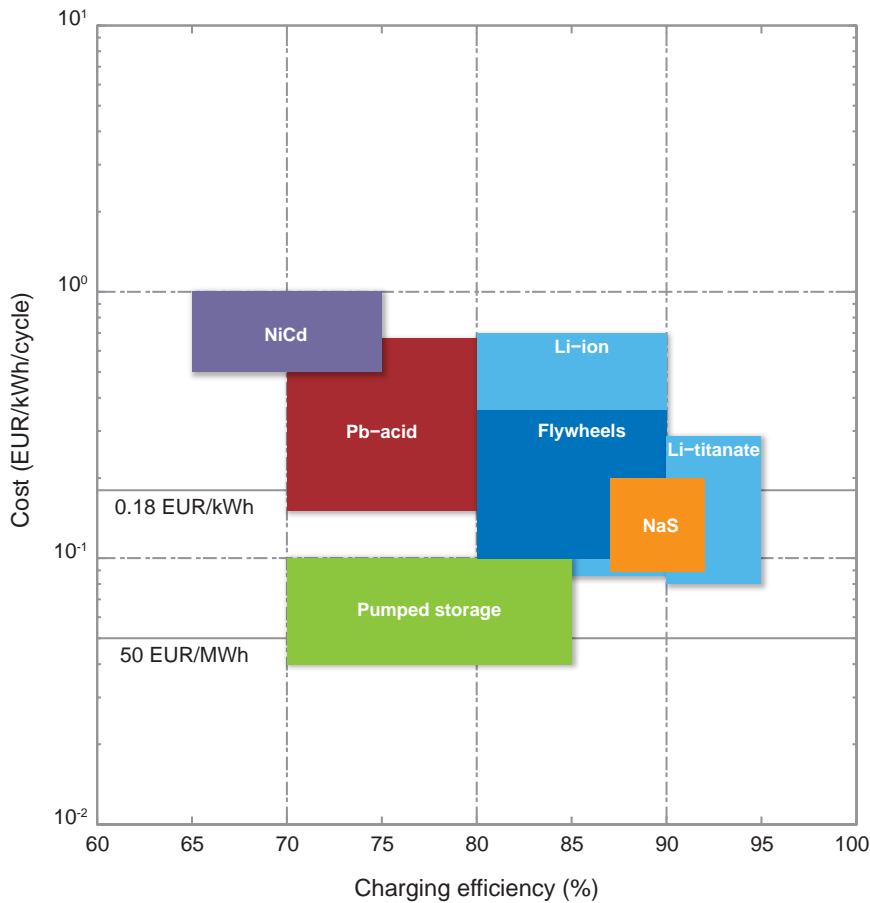
**Figure 6.4: Cost estimations of different energy storage technologies in use**

Source: Assembled from Poonpun and Jewell, 2008 and Ruddell (2003).

Electric vehicles, both battery electric vehicles (BEV) as well as plug-in hybrid electric vehicles (PHEV), are also very attractive in this respect. Electric vehicles possess batteries and can deliver services by delivering power back to the grid, the process known as vehicle to grid (V2G). This bidirectional energy flow can be used for peak-shaving, frequency control, emergency back-up. This also requires some grid adaptations. When implementing V2G, the increase in battery degradation has to be taken into account, because this degradation is a cost for the vehicle owner. This means that the profits for the owner when participating in V2G services have to be higher than the battery depreciation cost for the delivered services.

When introducing electric vehicles (BEV or PHEV), the electric energy consumption of the owners will rise significantly. For an average household, the electric energy required to charge the vehicle is about 4 000 kWh/year (driving 15 000 km/year with an efficiency of 4-7 km/kWh and taking into account a charging efficiency of 90%). For a Belgian family this is roughly the same magnitude as the amount of electricity for the rest of the household load which accounts for 3 500 kWh per year.

Smart grids will need to co-ordinate these massive additional flows, since if vehicles are charged without co-ordination, the impact on the electric energy system could be severe. Most vehicles would be charging simultaneously at the moment that the evening peak of the household loads occurs (Clement-Nyns, 2010). This combination of vehicle charging and high household loads results in an increased peak in electric energy consumption compared to the situation without electric vehicles. Because the electric energy infrastructure has to be sized for the peak demand, this increase in peak power implies that new investments in the grid infrastructure are needed.



However, if charging is done in a co-ordinated manner, these investments can be avoided or minimised. If co-ordinated charging is possible, vehicle charging can be seen as a type of demand-side management. The vehicles have to be completely charged at the time requested by the users, but the pattern of charging can be chosen freely within this time frame. By shifting vehicle charging away from the household load peak, the need for increased infrastructure will be reduced. Furthermore, if the vehicle charging flexibility is used to perform a valley-filling method, the baseload energy consumption will increase while maintaining the same peak consumption. This means less variance in consumption. Opportunities are created for investment in efficient baseload plants and the cycling of the expensive peak power plants decreases. This results in higher efficiency of the power generation system. Limiting the number of modulation cycles of power plants also limits the modulation costs, which form around 4-8% of the total electricity cost (Kempton and Tomic, 2005). As an example, in case of co-ordinated charging the present Belgian production infrastructure would allow for a penetration level of electric vehicles of 30% in the total vehicle fleet whereas unco-ordinated charging would set this limit at only 10%.

### **Smart grids and the role of nuclear power: a conclusion**

From the preceding paragraphs it transpires that smart grids will be the key technology to organise the flexibility provision necessary to respond to the load changes generated by variable renewables. This will facilitate the participation of renewable energy sources but also offer a higher potential for baseload capacity providers such as nuclear power. Their overall impact can be considered either from a local or a global perspective. In the local perspective, the emphasis is on the local and decentralised optimisation of the available resources that are physically close to the final consumer generator or the load. The global approach looks at the system as a whole, and aims at using the best available generation mix by connecting all available resources.

#### *The local perspective*

In this approach the grid is developed such that all or most services are delivered within a smaller regional grid, which leaves little room for nuclear power plants other than SMRs (see also next section). The idea is based on integrating the smaller-scale local generation close to the consumers (e.g. PV on rooftops). The local generation can thus compensate for local load and there is only limited need for significant grid investment as only the difference between local generation and load needs to be connected to the grid. This is only true under two conditions: the generation and load that are installed in the same part of the grid need to be roughly equal in size and the generation needs to coincide with the load. In case there is no local balance, there is still a need for grid investments, and in case the generation and load do not coincide, there is also a need for grid investments or local load flexibility through DSM or storage.

The local approach can also be applied to systems with mostly variable renewable energy generation. Through installation of sufficient storage near to the generators, a constant power output (renewables + storage) can be delivered to the grid. In such a system, the grid investments to the main grid can be minimised. A special case is a small city, neighbourhood or other sub-grid that tries to have a balanced energy supply and demand so that in case of problems the sub-grid can even be de-coupled from the main grid and be operated as an independent island grid or micro-grid. Demand-side management schemes are very typical for such concepts. Essential in micro-grids is to have local, decentralised control capability in the system. For instance, for the micro-grid to operate when disconnected from the main grid, adequate frequency control, voltage control, disconnection and re-synchronisation equipment and a protection system that works correctly both during synchronised operation as well as for islanded operation are needed. As a second advantage of this system the decentralised and independent control of the grid can be mentioned.

VPPs, a combination of different installations with distributed generation and DSM schemes, are an additional option. These multiple units act as a single entity in order to gain sufficient critical mass to participate as a larger player on the electricity market. It may also enable the group to provide a more balanced generation portfolio. VPPs do not need to be located at a single point, nor do they need to be

owned by a single entity. Depending on the size of a VPP, a small nuclear load following power plant could be part of it. More interestingly, however, a VPP would deliver dispatchability to a system and could thus complement the constant output of baseload nuclear plants by absorbing the fluctuations of demand and variable renewable production.

### *The global perspective*

The idea of absorbing variability, either introduced by demand or supply, can of course be scaled also at a larger level. Here, geographical smoothing can be enabled by building sufficient transmission capacity. For example the main problem of intermittency of wind generation is largely cancelled if the wind generation is spread over a sufficiently large area. The probability that there is no (or maximum) wind in the north of Germany and Spain at the same time is relatively low. By connecting and fully integrating those two regions, the average output will have a much smoother behaviour. The energy supply will have a larger proportion consisting of centralised baseload, which is advantageous for the large scale integration of renewables, but also for other low-carbon energy sources such as nuclear energy. The requirement for this geographic smoothing or balancing is sufficient transmission capacity which means installing new transmission lines. This approach is often referred to as a super-grid. It would allow the optimal use of available resources.

In Europe the abundant wind resources from the North Sea and Spain and the available solar energy from the Mediterranean and North African region would be coupled with the hydropower installations from the Alps and Scandinavia. At any moment the cheapest energy resources can be used while the balancing can be done using the very flexible hydropower plants.

The most realistic option for a “super-grid” in Europe makes use of HVDC cable connections (Van Hertem, 2011). ENTSO-E has started to work on a roadmap to implement this new grid in its “Modular Development Plan on Pan-European Electricity Highways System 2050”. Also in China a new overlay system is considered. There the emphasis lies on connecting renewable energy sources from the centre of the country to the large cities close to the shore in the East. China is currently building a new grid using both HVDC and AC at voltages well over 500 kV.

It is reported among others by Energynautics that in order to connect all renewables (without curtailment) that are expected by 2030, a fundamental upgrade of the electric transmission system is required (the global approach). The effect of local solutions (extended use of DSM, integration of EV and storage) on the curtailment of renewable energy is limited. As such, the development of the renewable energy sector is in line with the requirements for a stronger transmission grid, which can also be beneficial to other generators of baseload energy such as nuclear energy. The Energynautics study also indicated that for full integration of renewable energy without curtailment, traditional baseload generators would require flexibility in their generation profiles.

### *The role of nuclear power in the local and the global approach: conclusions*

In order to obtain the optimal grid operation, both the “local” and the “global” approach will be part of the solution. The local vision through activities such as DSM will allow a more optimal use of local resources with a limited role for nuclear energy. The global vision connects all generation and load together to get a higher overall social welfare, with the lowest overall energy cost. Given that this will smooth daily, seasonal and annual load curves, the role for baseload technologies such as nuclear energy will be considerably enhanced (see Figure 6.5 which is for expositional purposes only; in practice, the ability of smart grids to smooth the annual load curve would be somewhat more modest).

Nuclear power can participate in the transformation of electricity markets engendered by the opportunities offered by smart grids in several ways. In the local decentralised setting, smart grids can enable local demand-supply balancing including nuclear power. Employing large baseload facilities at continuous output as such might be less obvious in this setting. Nevertheless, through the local balancing, the remaining energy provision can be flatter and a higher need for baseload generation might arise. Nuclear power plants could also be part of virtual power plants (consisting of a wide mix of generation and demand-side technologies), likely operating with modulating output. It will depend on the specific

setting, the business models of different participants as well as the availability of storage to which extent there is room for nuclear in these models. Smart grids are an enabling technology for such a local approach, but in the end, the potential for (nuclear) baseload will depend (a) on the penetration level of renewables, (b) the size of a nuclear power plant relative to the local grid and (c) the potential for demand-side actions combined with storage co-ordinated by the local smart grid.

**Figure 6.5: The optimal amounts of nuclear capacity with and without annual load smoothing due to smart grids and virtual power plants**

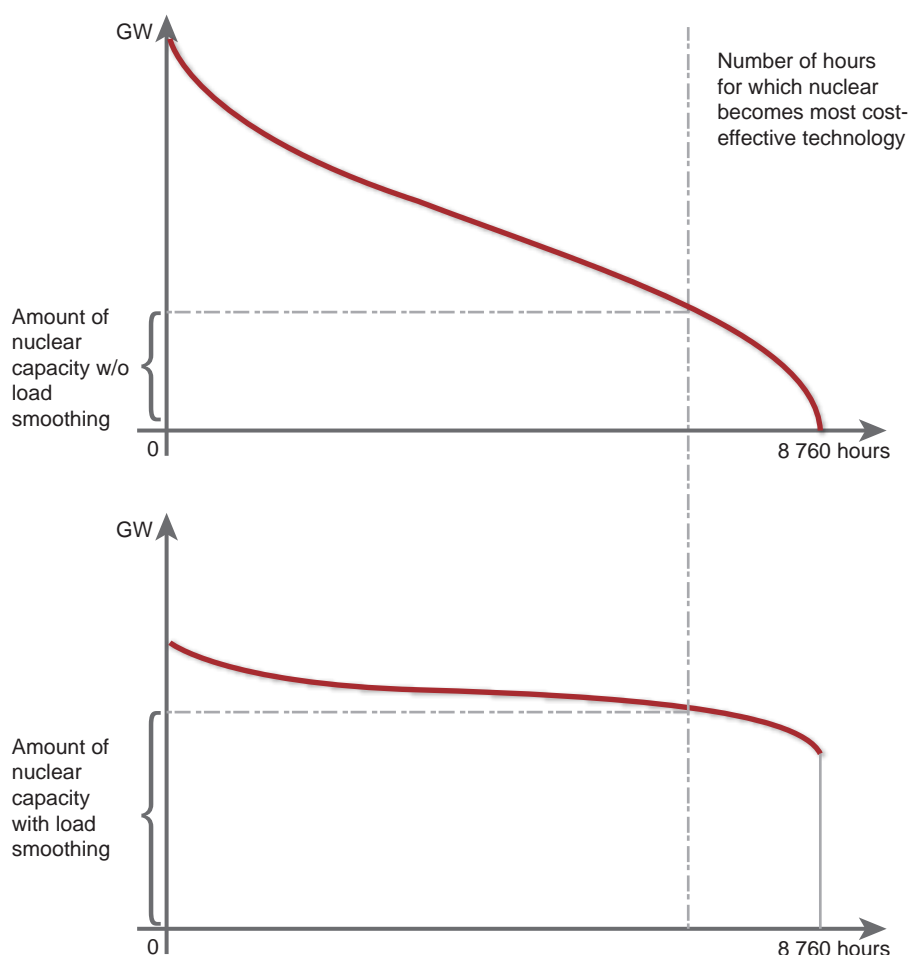

In the global approach, the possible role for (nuclear) baseload will depend also on the need for constant demand from conventional power plants by continuously adapting the demand curve by smart grid technologies via demand-side participation but also on the geographic area considered. The first aspect concerns the adaptation of the demand curve. As discussed earlier, smart grids have the capabilities to provide flexible load curves, through demand response, demand shifting and integration of storage. The key question here also relates to the potential, and to which extent this potential might be used in a geographic wide setting. At this moment, smart grids projects are in a piloting phase, so the full potential of demand response and demand shifting is not yet clear. It will also depend on whether and how specific options for storage might develop (e.g. electric vehicles). It could be that they are either used to deal with local issues and help in more local demand-supply balancing (even in this overall global approach), rather than to aim for system wide flatter net-load curves.

Concerning the second point, it is clear that the larger the area considered, statistically, the better the smoothening from renewables will be. If so-called super-grids are to be developed, and if these provide sufficiently large interconnection capacities across regions, a system-wide minimum load might be available, providing again an opportunity for nuclear baseload. The extent to which super-grids will be developed, remains, however, uncertain (see the barriers for investment in transmission capacity that are discussed earlier in this report).

In conclusion, smart grids can play an important role in achieving flatter load curves, thereby providing an increased role for nuclear baseload generation. However, to which extent the system will actually evolve this way is difficult to predict. Smart grids have many features and may serve various purposes. It will depend on many factors, some political and some such as technology development and demand-side potential as well as on the system that will evolve (local, global and/or combined approach). Based on those inputs, the business models that will be developed will also determine the potential for nuclear baseload. The question whether the role for nuclear baseload with its high fixed and low variable costs generation will increase or rather decrease, depends on many different factors (intermittent renewable generation, load profiles, grid stability, security of supply reasons, the potential for demand-side management and others) and the relative costs associated with them. Time will tell what the optimal solution will turn out to be.

## 6.2 The economic potential of small modular reactors in integrated electricity systems<sup>3</sup>

In recent years, in the wake of a renewed interest in nuclear energy, several reactor designs have been proposed: large scale plants of more than 1 000 MW capacity, such as the EPR and the AP 1000, but also a new category of SMR with an electrical output lower than 300 MW.<sup>4</sup> Historically, early reactors were smaller and the general trend has always been towards larger unit sizes, which allows for lower specific investment and O&M costs due to the economy of scale. Large nuclear power plants (above 700 MW) constituted more than 80% of the nuclear capacity connected to the grid after 1990, while small reactors represented only 4% of the total capacity installed.

Currently, the deployment of SMRs has been envisaged in niche markets that cannot accommodate large nuclear power plants: this applies to remote or isolated areas where large generating capacities are not needed, electrical grids are poorly developed or absent, and where non electrical products (such as heat or desalinated water) are as important as the electricity. Beside those niche markets, deployment of SMRs is also considered in traditional markets, in direct competition with large NPPs. Their smaller size eases their siting and integration into the electrical grid and guarantees stronger operational flexibility, thus reducing the system costs. From an economic viewpoint, SMRs have higher specific investment costs and, consequently, higher LCOE than larger nuclear units (Boarin, 2012). However, SMRs have the advantages of shorter construction times, much smaller upfront capital investments and greater financing flexibility. Thus, the utilities have the opportunity to increase progressively the nuclear capacity and to postpone or suspend investments in response to changing market conditions. Together, those characteristics results in smaller financial risk, making such reactors potentially attractive to private investors and to countries initiating a nuclear programme.

3. This section is a synthesis of work by Marco Mancini of Politecnico of Milano and Giorgio Locatelli of the University of Lincoln (Locatelli and Mancini, 2011a, 2011b and 2011c). Their work was subsequently prepared as a contribution to the work of the NEA WPNE by Marco Ricotti and Sara Boarin from Politecnico di Milano.

4. Two definitions of SMR are currently used in the literature: small- and medium-size reactors and small modular reactors. IAEA defines as “small” those reactors having an equivalent electrical power lower than 300 MW and as “medium” those with the equivalent electrical power between 300 and 700 MW (IAEA, 2006). In the context of the present study, the second definition is adopted, focusing mainly on small modular reactors.

The purpose of this study is to assess the advantages of SMRs with respect to large reactors in reducing the system costs of nuclear power. In particular, SMRs are easier to integrate into the electrical grid due to their limited size, which reduces the requirements for spinning reserves and the grid vulnerability. Also, the limited size of SMRs allows for a greater operational flexibility that is beneficial for the whole electrical system. These aspects are treated in the first section of this study, with a direct application to the Italian electricity market. The second section of the study briefly summarises the economical and financial advantages of smaller modular reactors for an investor. The smaller size of SMRs offers a broader range of opportunities for choosing the generating portfolio and grants a higher flexibility in the investment decision. The shorter construction time and the possibility of fractioning the investment in several subsequent units allow the utility to differ or suspend a nuclear project if the market conditions are not favourable. This reduces the overall financial risk of a nuclear project. Investment flexibility is particularly valuable in deregulated electricity markets, where electricity market prices may have higher variability.

### **System effects of SMRs – frequency control and grid vulnerability**

The grid operator is responsible for maintaining the security and quality of electricity supply. In order to continuously re-establish the balance between load and generation, a certain amount of active power is kept in reserves: such reserves are usually referred as “spinning reserves”, but definitions vary among countries (Rebours and Kirshner, 2005; Kirby, 200; Bovo *et al.*, 2005). In Chapter 2 those reserves were subdivided into primary, secondary and tertiary reserves depending upon the time window of availability. Supply of spinning reserves is a TSO’s duty: it buys forecasted bands of generation capacity from utilities mechanisms, which are always country-dependent. From an economic viewpoint, reserve provision represents a cost for the TSO and, indirectly for the final user.

There exist two main methods to determine spinning reserves:

- *Deterministic methods.* The primary objective here is to maintain security and quality of supply. The amount of reserves must cover the worst power station outages named largest contingency (LC) (Ortega-Vasquez *et al.*, 2006 and O’Sullivan and O’Malley, 1999).
- *Optimising methods.* The trade-off between cost and service is optimised by probabilistic methods, linear programming, cost/benefit analysis and unit commitment programmes (Galiana *et al.*, 2005, Ortega-Vasquez *et al.*, 2006, Gooi *et al.*, 1999, Ruiz and Sauer, 2008 and Streiffert, 1995). They require the estimation of the probability and amount of load shedding for different system conditions (TERNA, 2004).

A schematic representation of the management of a generation unit outage is illustrated in Figure 6.6 and Table 6.1. Six units serve six isolated load areas: when unit No. 6 turns-off, the 6<sup>th</sup> area’s demand should be satisfied by other active units. After the first frequency drop, units serving areas from 1 to 5 will increase their output under signal from TSO, provided that the grid connections have enough transport capacity to bear additional load.

The introduction of a new power plant into an electrical grid may require an increase in the amount of spinning reserves, depending on the size of the new power plant with respect to that of the existing plants, their geographical distribution and the availability of interconnections. For instance, the construction of a new large nuclear plant may require increasing spinning reserves, which would not be needed if several smaller units are built instead. Thus, spinning reserves are potentially a differentiating factor between large reactors and SMRs and could favour the choice of smaller reactors.

The following case study, based on the Italian electricity market, quantifies the increase in spinning reserves after the introduction of 8 large nuclear power plants of 1 340 MW with that of several SMRs of 335 MW delivering the same capacity. Even if most of the results are related to Italy, the methodology used can be applied everywhere and the conclusion shared with other OECD countries that do not have already large power units in their generating mix.

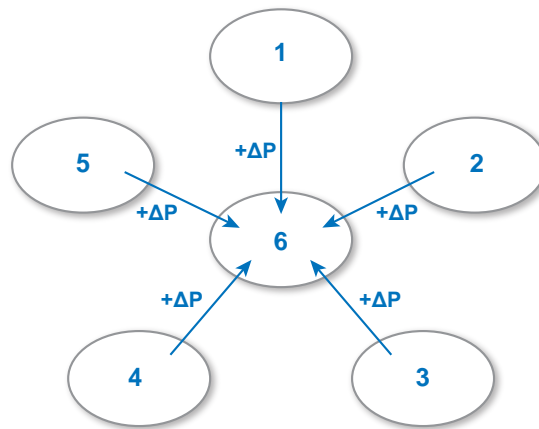
**Figure 6.6: Electricity flows after the outage of a generating unit**

Source: Locatelli and Mancini, 2011a.

**Table 6.1: Electricity flows after the outage of a generating unit**

Conditions		Power (MW)		
		Areas 1-5	Area 6	Total
Normal operation	Generation	100	100	600
	Load	100	100	600
Unit 6 outage	Generation	100	0	500
	Load	84	80	500
After reserve activation	Generation	120	0	600
	Load	100	100	600

Source: Locatelli and Mancini (2011a).

### A case study: the Italian scenario

In the Italian electricity market, the TSO defines the amount of spinning reserves in a deterministic way, using the largest contingency method. The Italian TSO buys spinning reserves and other ancillary services from utilities in the market for dispatching services (Bovo *et al.*, 2005). According to the Italian grid code, every generating unit must guarantee a  $\pm 1.5\%$  band of capacity as primary reserves for the continuous balance of the system. In case of plant outages, those reserves are activated automatically after the immediate fall of frequency, and are restored as soon as possible by the intervention of frequency restoration and replacement reserves (TERN, 2004).

The methodology used to calculate spinning reserves and thus to quantify the impact of reactor size on the required reserves is described in the following steps:

- Step 1: split the electric system into different areas that can be considered like isolated systems; it is assumed that units of the same area only can supply active power (O'Sullivan and O'Malley, 1999).
- Step 2: calculate the largest contingency for every area, as the sum of the two largest generating units. The worst event is the contemporary outage of the two main autonomous groups of generation in that area.<sup>5</sup>

5. Recommendations from UCTE state that the whole frequency restoration and replacement reserve is sized to meet the loss of the largest generation unit of the control area considered (HVDC link, busbar section, generator or a set of generators sensitive to a common mode failure). According with those recommendations, the largest normal contingency in Italy would correspond to the maximum generation infeed loss.

- Steps 3 and 4: assume the deployment of a single 1 340 MWe large unit or four stand-alone 335 MWe in each area and calculate the new largest contingency for each of those two cases. The difference between the new largest contingency and the one without the new plants will determine the amount of additional spinning reserves required.

This algorithm has been applied to the Italian case. The Italian electric system was split into the same eight areas used by the national control centre of the Italian TSO (TERNA, 2008 and TERNA, 2009) and shown in Figure 6.7. Finally, the largest generating units owned by Italian utilities are shown in Table 6.2, in the current situation and according to the two scenarios analysed. The construction of a large nuclear unit in every area would require, on average, a 61.8% increase in spinning reserves, while the construction of SMRs would not vary the current situation.

Figure 6.7: Main areas of the Italian electric system

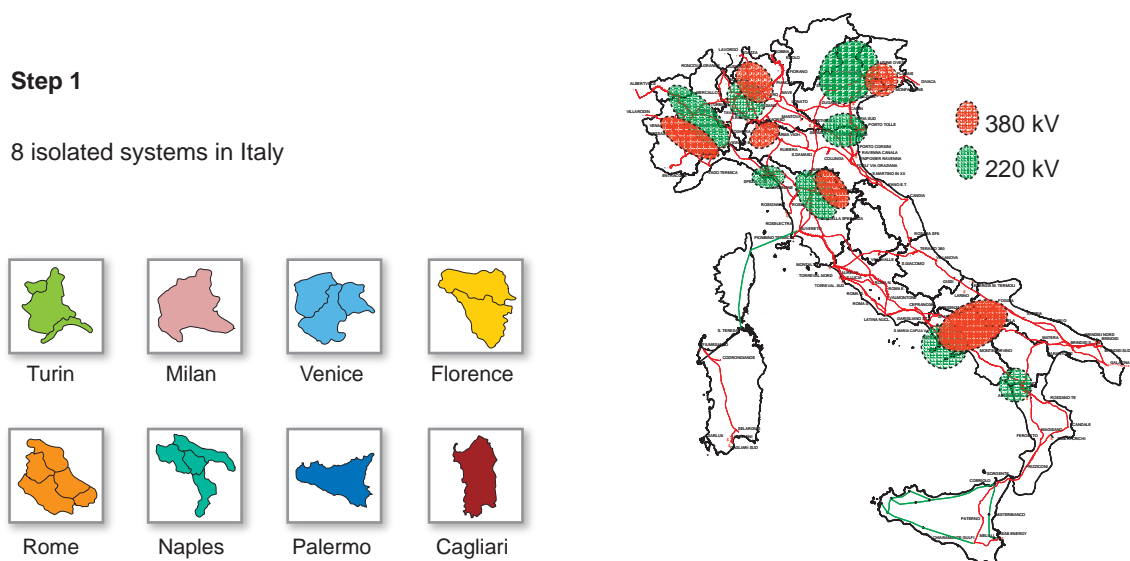

Source: Based from Terna, 2009.

Table 6.2: Actual and differential reserves in the Italian scenario

Area	Actual		1 LR			4 SMR		
	WE	LC	WE	LC	DIFF.	WE	LC	DIFF.
Turin	790+800	1 590	1 340+800	2 140	550	As actual	1 590	0
Milan	800+850	1 650	1 340+850	2 190	540	As actual	1 650	0
Venice	660+660	1 320	1 340+660	2 000	680	As actual	1 320	0
Florence	390+390	780	1 340+390	1 730	950	As actual	780	0
Rome	770+660	1 430	1 340+770	2 110	680	As actual	1 430	0
Naples	660+660	1 320	1 340+660	2 000	680	As actual	1 320	0
Palermo	376+376	752	1 340+376	1 716	964	As actual	752	0
Cagliari	575+350	925	1 340+575	1 915	990	As actual	925	0
<b>SUM</b>		9 767		15 801	6 043		9 767	0
<b>RATIO</b>	Step 4		<b>+61.8%</b>			<b>+0.0%</b>		

Source: Locatelli, 2010.

The present study confirms that the integration of large nuclear units into the Italian electricity market would require an increase of replacement reserves that would not be needed if SMRs are deployed instead. In this context the choice of SMRs would therefore result in lower system costs. This result, however, depends strongly on the size and the geographic distribution of existing generating units as well as on the available interconnections and cannot be generalised to other countries. For instance, improving interconnections among different areas in the country would reduce electricity transmission congestion and thus the overall spinning reserves requirements.

Similar considerations apply when considering the vulnerability of the electrical system in case of natural calamities, power system component failures, human errors, etc. The main effects of vulnerability are large blackouts due to cascading failures of a large number of transmission lines. While spinning reserves deal with outages of generating units, vulnerability analysis focuses on failures of the transmission lines, assuming that generators are fully available. When a power line fails, the electric flow is shifted to the neighbouring lines, which might become overloaded. In these cases, new failures can lead to a cascading effect with consequences on the whole electric system. Cascading failures led to the blackout in 11 different western states of the United States, on 10 August 1996, and to the largest blackout in the United States' history on 14 August 2003 (Crucitti *et al.*, 2004). Again, the wider distribution and multiple grid connections of SMRs offer certain advantages here.

### Other system effects and conclusion

Small-medium reactors have the potential to be a part of global nuclear development also because they require limited front-end investments and offer the option to increase power generation capacity by adding successive units at the same site (Carelli *et al.*, 2010). This makes SMRs a “modular” investment, characterised by the option of small power increments through the deployment of successive units. SMRs offer the investor higher flexibility than large reactors in investment decision-making in two ways:

- *Portfolio management*: smaller nuclear units allow the investor high flexibility in the composition of their generation portfolio: more combinations are possible of different plant technologies, given financial investment constraints.
- *Capital budgeting*: smaller nuclear units allow the investor more flexibility about if and when to add capacity or to defer or even cancel the deployment of further nuclear plants.

Both issues relate to investor flexibility and have an influence on electricity generation cost level and its stability.

As far as *portfolio management* is concerned, mean variance portfolio theory (MVP) is the most widely used method for optimisation of the electricity generation mix. Each generating portfolio is characterised by its expected return, expressed by the internal rate of return (IRR) and its standard deviation (Markowitz, 1952). The latter characterises the risk of the investment since it measures the variability of possible outcomes with respect to the expected value. The optimal portfolio is the one that offers the maximal level of return (IRR expected value) for a given level of risk (IRR standard deviation); conversely, the optimal portfolio may be viewed as the one that offers the lowest risk for a given level of expected return.

The analysis requires assumptions about the probabilistic distributions of main factors, such as electricity price, as well as investment, operating and fuel costs for each specific generation technology. When fossil fuels are considered, assumptions about CO<sub>2</sub> emissions costs also have to be made. Nuclear investment is represented by large reactor and SMR alternative investments, which are competing with other “baseload technology” such as coal and CCGT. The size of the electricity market also has a significant impact on the optimal generating portfolio. Therefore, two reference electricity markets have been analysed, a large market of 30 GW and a small market of 2 GW, which represent a national electricity market and a municipality or island, respectively.

When applied to large electricity markets and large utilities, MVP analysis does show that the optimum generating portfolio mix would include large NPPs in most cases. However, in small markets, where a plant size is comparable to the network capacity, the deployment of a new plant has a heavier impact and, as far as large plants are considered, fewer possible combinations are able to match the optimum portfolio mix. Here the SMR choice would increase the portfolio options available and allow for a greater diversification in the generation mix.



As far as *capital budgeting* is concerned, SMRs offer more flexibility in the investment decision than traditional large power units. Due to the potentially shorter construction time and the possibility to subdivide the initial investment, SMRs help nuclear developers to match market forecasts or adapt their investment to changed scenario conditions. Investment flexibility would allow limiting losses in down-turns or catching higher profit opportunities in up-turns of the market cycle. This is particularly valuable in liberalised markets where utilities are faced with sources of uncertainty arising mainly from increased market volatility (level of future demand and supply, future market prices) but also from uncertainties regarding the future legal the electricity generation environment.

The value of investment flexibility may be quantified by the real option approach and considered as an additional component to the “static” (without flexibility, e.g. based on a fixed investment schedule) net present value analysis of an investment project, such as the LCOE. An option arises when information can modify the outcome of future investment decisions (see Table 6.3). This methodology is particularly applicable when there is a high degree of uncertainty, some managerial flexibility, and not all information is known at a given time.

**Table 6.3: Type of options available to the investor**

Options	Description
<b>Abandon</b>	By creating the abandonment option, the investor may avoid pursuing a project, should the business conditions turn into a negative scenario (Brach, 2003 and Mun, 2002).
<b>Expand</b>	Management can expand production or increase resource deployment if the market environment develops favourably (Rogers, 2002).
<b>Delay/defer</b>	The delay option is exercised when the owner of the rights to the project can decide when to invest in it (Brach, 2003 and Mun, 2002).
<b>Stage</b>	Concerns the ability to break-up the investment into incremental, conditional steps (Brach, 2003).
<b>Learn</b>	Concerns the ability to reduce investment uncertainty by obtaining a reliable and precise understanding of the future (Brach, 2003).

Preliminary analysis has been run through Monte Carlo simulation and applied to a single large reactor investment project, compared to multiple SMRs with equivalent power installed. “Build” or “wait” alternative decisions have been considered, each decision opening the path to further possible decisions (i.e. keep waiting or build unit n+1). Results show that the higher flexibility of SMRs, i.e. the higher number of decisions that may be taken with reference to the investment scenario, translates into higher option values, and thus a higher increase on the net present value. As expected, the real option value increases with the uncertainty of future cash flows, due to higher volatility of electricity prices, investment costs or marginal cost of production. Also, the option value is inversely correlated with the long-term level of electricity prices.

Real option analysis shows that managerial and investment flexibility has a value that cannot be assessed with traditional net present value analysis. Also, the option value is always higher in a modular project involving several SMRs than in a project with a single large unit of the same size. The additional value of flexibility in an SMR project may translate into a more effective investment strategy, especially at lower electricity prices: in those conditions, the same investment may be considered economically viable with SMRs, but not with large reactors.

Given their technical advantage for the design of electricity systems with adequate reserve margins as well as their financial advantage for portfolio management and capital budgeting, SMRs have indeed a number of attractive features compared with traditional nuclear power plants or any other large power plant of comparable size and total cost. Their key challenge currently remains their high costs per unit of output and the regulatory issues raised by substantial numbers of decentralised units. Several initiatives in OECD countries, in particular the United States, are currently under way to meet this challenge. Time will tell whether further technological evolutions or scale economies due to offsite manufacturing in combination with the positive system effects outlined above will suffice to make SMRs an economically sustainable option for large-scale electricity production.

## References

- ABB (2010), “Smart Grids”, *ABB Review*, 1/10.
- Ahlert, K.-H. (2009), “Assessing the Economics of Distributed Storage Systems at the End Consumer Level”, Proceedings of IRES Eurosolar Conference, 24-25 November, Berlin, Germany.
- Ahlert, K.-H. (2010), “Economics of Distributed Storage Systems: An Economical Analysis of Arbitrage-maximizing Storage Systems at the End Consumer Level”, PhD thesis, Karlsruher Institut für Technologie (KIT), Germany.
- Boarin, S. and M.E. Ricotti (2012), “Financial Case Studies on Small-medium Sized Modular Reactors”, *Nuclear Technology*, Vol. 178, May.
- Bovo, A., C. Benini, M. Migliavacca and G. Berizzi (2005), *I servizi ancillari e la remunerazione del reattivo nei mercati elettrici liberalizzati*, Milano, Italy.
- Brach, M.A. (2003), *Real Options in Practice*, John Wiley, Hoboken, NJ.
- Cao, J. and A. Emadi (2011), “Batteries Need Electronics”, *Industrial Electronics Magazine, IEEE*, Vol. 5, No. 1, pp. 27-35, March.
- Carelli, M.D., P. Garrone, G. Locatelli, M. Mancini, C. Mycoff, P. Trucco and M.E. Ricotti (2010), “Economic Features of Integral, Modular, Small-to-medium Size Reactors”, *Progress in Nuclear Energy*, May, Vol. 52, Issue 4, pp. 403-414.
- Clement-Nyns, K. (2010), “Impact of Plug-in Hybrid Electric Vehicles on the Electricity System”, PhD thesis, KUL, Leuven, Belgium.
- Crucitti, P., V. Latora and M. Marchiori (2004), “A Topological Analysis of the Italian Electric Grid”, *Physica A*, July, Vol. 338, Issues 1-2, pp. 92-97.
- De Craemer K. and G. Deconink (2010), *Analysis of State-of-the-art Smart Metering and Communication Standards*, YRS edition 2010, 29-30 March, Leuven, Belgium.
- Delta Energy & Environment (2011), *Driving a Resource Efficiency Power Generation Sector in Europe*, Final Report, 19 May.
- D’haeseleer, W. (2011), “Nuclear Energy as Part of the Electricity Generation System – Balancing and the Grids”, TME Working Paper EN2011-02, Katholieke Universiteit Leuven Energy Institute (KUT), Leuven, Belgium, available at [www.mech.kuleuven.be/en/tme/research/energy\\_environment/Pdf/WPEN2011-02](http://www.mech.kuleuven.be/en/tme/research/energy_environment/Pdf/WPEN2011-02).
- DOE (n.d.), *The Smart Grid: An Introduction*, Department of Energy, Washington, D.C., United States [http://energy.gov/sites/prod/files/oeprod/DocumentsandMedia/DOE\\_SG\\_Book\\_Single\\_Pages%281%29.pdf](http://energy.gov/sites/prod/files/oeprod/DocumentsandMedia/DOE_SG_Book_Single_Pages%281%29.pdf).
- EAC (2008), *Bottling Electricity Storage as a Strategic Tool for Managing Variability and Capacity Concerns in the Modern Grid*, A Report by Electricity Advisory Committee to the US Department of Energy, Washington, D.C., United States.
- EC (2006), *Vision and Strategy for European Electricity Networks of the Future*, Smart Grids European Technology Platform, European Commission, Brussels, Belgium.
- EC (2007), *Strategic Research Agenda for Europe’s Electricity Networks of the Future*, Smart Grids European Technology Platform, European Commission, Brussels, Belgium. Available at [www.smartgrids.eu/documents/sra/sra\\_finalversion.pdf](http://www.smartgrids.eu/documents/sra/sra_finalversion.pdf).
- EC (2009), *ICT for a Low Carbon Economy: Smart Electricity Distribution Networks*, European Commission Directorate-General Information Society and Media (DG INFSO), July, Brussels, Belgium, <http://ec.europa.eu/ict4ee>.
- EC (2010), *Strategic Deployment Document for Europe’s Electricity Networks of the Future*, Smart Grids European Technology Platform, European Commission, Brussels, Belgium. Available at [www.smartgrids.eu/documents/SmartGrids\\_SDD\\_FINAL\\_APRIL2010.pdf#\\_blank](http://www.smartgrids.eu/documents/SmartGrids_SDD_FINAL_APRIL2010.pdf#_blank).

- ECF (2010), *European Climate Foundation, Decarbonization Roadmaps for the EU-27*, European Climate Foundation, Brussels, Belgium.
- Electrical Storage Association, available at [www.electricitystorage.org](http://www.electricitystorage.org).
- ENTSO-E (2011), *Study Roadmap towards Modular Development Plan on pan-European Electricity Highways System – Way to 2050 pan-European Power System*, Brussels, Belgium, [www.entsoe.eu/fileadmin/user\\_upload/\\_library/events/Workshops/Modular\\_development\\_2050/110502\\_MoDPEHS\\_StudyRoadmap\\_Draft3\\_public.pdf](http://www.entsoe.eu/fileadmin/user_upload/_library/events/Workshops/Modular_development_2050/110502_MoDPEHS_StudyRoadmap_Draft3_public.pdf).
- EPRI (2011), *Estimating the Costs and Benefits of the Smart Grid: A Preliminary Estimate of the Investment Requirements and the Resultant Benefits of a Fully Functioning Smart Grid*, Technical Report, Electric Power Research Institute, Palo Alto, CA, United States.
- EREC (2010), *European Renewable Energy Council, RE-thinking 2050 – A 100% Renewable Energy Vision for the European Union*, Brussels, Belgium.
- EU WG3 (2010), *Energy Retailers' Perspective on the Deployment of Smart Grids in Europe*, Smartgrids ETP, WG3: Demand and metering, European Union. Available in [www.smartgridsflanders.be/sites/default/files/nieuws/ETPSmartGrids\\_EnergyRetailers\\_WhitePaper\\_Final\\_v1.0.pdf](http://www.smartgridsflanders.be/sites/default/files/nieuws/ETPSmartGrids_EnergyRetailers_WhitePaper_Final_v1.0.pdf)
- EURELECTRIC (2010), *Power Choices 2050*, Brussels, Belgium.
- EURELECTRIC (2011), *Regulation for Smart Grids*, D/2011/12.205/3, February, Brussels, Belgium.
- Fox-Penner, P.S. (2010), *SMART power – Climate Change, the Smart Grid, and the Future of Electric Utilities*, Island Press, Washington, D.C., United States.
- Galiana, F.D., F. Bouffard, J.M. Arroyo and J.F. Restrepo (2005), “Scheduling and Pricing of Coupled Energy and Primary, Secondary and Tertiary Reserves”, *Proceedings of the IEEE*, Vol. 93, Issue 11, November, pp. 1970-1983.
- Gaul, A.J., J. Nilges, E. Nockmann and H. Spitzer (2005), “Asset Simulation: an Approach to Predict the Long Term Monetary Consequences of Maintenance and Renewal Strategies for Electrical Grids”, 19<sup>th</sup> International Conference on Electricity Distribution (CIRED), Vienna, 21-24 May.
- Gollier, C., D. Proutt, F. Thais and G. Walgenwitz (2008), “Choice of Nuclear Power Investments under Price Uncertainty: Valuing Modularity”, *Energy Economics*, Vol. 27, Issue 4, pp. 667-685.
- Gooi, H.B., D.P. Mendes, K.W.R. Bell and D.S. Kirschen (1999), “Optimal Scheduling of Spinning Reserve”, *IEEE Transaction on Power Systems*, Vol. 14, Issue 4, pp. 1485-1492.
- Haesen, E. (2009), *Multi-Objective Optimization of the Integration of Stochastic Distributed Energy Resources in Electricity Grids*, May, ESAT, KUL Leuven, Belgium, [www.esat.kuleuven.be/electa/publications/fulltexts/pub\\_2153.pdf](http://www.esat.kuleuven.be/electa/publications/fulltexts/pub_2153.pdf).
- Horwitz Jr., J.M., B. Kallo and R. Fong (2010), “Clean Technology: 2010: A Smart Grid Odyssey: Improving Control, Efficiency, and Reliability of the Electricity Grid”, *Energy Research*, January, Robert W. Baird & Co., London, United Kingdom.
- IAEA (2006), “Status of Innovative Small and Medium Reactor Designs 2005. Reactors with Conventional Refuelling Schemes”, IAEA-TECDOC 1485, Vienna, Austria.
- IEA (2009), *Hybrid and Electric Vehicles: the Electric Drive Establishes a Market Foothold*, IEA Hybrid & Electric Vehicle Implementing Agreement (IA-HEV), February, International Energy Agency, OECD, Paris, France.
- IEA (2010a), *Energy Technology Perspectives (ETP) 2010*, International Energy Agency, OECD, Paris, France.
- IEA (2010b), *World Energy Outlook 2010*, International Energy Agency, OECD, Paris, France.
- IEA (2011), *Technology Roadmap: Smart grids*, International Energy Agency, OECD, Paris, France.
- Ipakchi, A. and F. Albuyeh (2009), “Grid of the Future: Are we Ready to Transition to a Smart Grid?”, *Power and Energy Magazine*, IEEE, March-April, Vol. 7, Issue 2, pp. 52-62.

- Jongepier, A.G. (2007), *Ageing Networks: Consume, Prolong or Replace*, Leonardo Energy Electricity Briefing Paper, January. Available in [www.leonardo-energy.org/files/root/pdf/2007/AgeingAssets.pdf](http://www.leonardo-energy.org/files/root/pdf/2007/AgeingAssets.pdf).
- Kempton, W. and J. Tomic (2005), “Vehicle-to-grid Power Fundamentals: Calculating Capacity and Net Revenue”, *Elsevier Journal of Power Sources*, 144, pp. 268-279.
- Kirby, B.J. (2003), “Spinning Reserve from Responsive Loads”, Oak Ridge National Laboratory, ORNL/TM-2003/19, March. Available at <http://certs.lbl.gov/pdf/spinning-reserves.pdf>.
- Lauferts, U. and L. Van den Durpel (2008), “Exploring Real Option Analysis in Nuclear Energy Assessment Studies”, 12<sup>th</sup> Annual International Conference in Real Options, 9-12 July, Rio de Janeiro, Brazil.
- Leemput, N, J. Van Roy, F. Geth, P. Tant, B. Claessens and J. Driesen (2011), *Comparative Analysis of Coordination Strategies for Electric Vehicles*, IEEE ISGT Europe, Manchester, United Kingdom.
- Lesemann, M. (2011), *Societal Scenarios and Available Technologies for Electric Vehicle Architectures in 2020*, Deliverable D1.1, Advanced Electric Vehicle Architectures ELVA Consortium, Aachen, Germany. Available in [www.elva-project.eu/pdf/ELVA-110331-D11-V10-FINAL.pdf](http://www.elva-project.eu/pdf/ELVA-110331-D11-V10-FINAL.pdf).
- Locatelli, G. (2010), “Introducing Nuclear Power Plants in an OECD Country: Size Influence on the External Factors”, ICONE18-29460, Proceedings of the 18<sup>th</sup> International Conference on Nuclear Engineering ICONE18, 17-21 May, Xi’an, China.
- Locatelli, G. and M. Mancini (2011a), “The Role of the Reactor Size for an Investment in the Nuclear Sector: An Evaluation of Not-financial Parameters”, *Progress in Nuclear Energy*, Vol. 53, Issue 2, March, pp. 212-222.
- Locatelli, G. and M. Mancini (2011b), “Large and Small Baseload Power Plants: Drivers to Define the Optimal Portfolios”, *Energy Policy*, December, Vol. 39, Issue 12, pp. 7762-7775.
- Locatelli, G. and M. Mancini (2011c), “Evaluating Flexibility in Nuclear Plant Investment: a Real Options Approach”, IPMA.
- Markowitz, H.M. (1952), “Portfolio Selection”, *Journal of Finance*, 7, pp. 77-91.
- Meeus, L., K. Purchala and R. Belmans (2005), “Development of the Internal Electricity Market in Europe”, *Electricity Journal*, 18 (6), pp. 25-35.
- Meeus, L., M. Saguan, J.M. Glachant and R. Belmans (2011), “Smart Regulation for Smart Grids”, *EU Energy Innovation Policy Towards 2050*, Claeys & Casteels Publishers.
- Mun, J. (2002), *Real Options Analysis – Tools and Techniques for Valuing Strategic Investments and Decisions*, John Wiley and Sons.
- NEA (2011), *Current Status, Technical Feasibility and Economics of Small Nuclear Reactors*, Nuclear Energy Agency, OECD, Paris, France. Available at [www.oecd-nea.org/ndd/reports/2011/current-status-small-reactors.pdf](http://www.oecd-nea.org/ndd/reports/2011/current-status-small-reactors.pdf).
- NIST (2010), *Framework and Roadmap for Smart Grid Interoperability Standards*, Release 1.0, NIST Special Publication 1108, National Institute of Standards and Technology, US Department of Commerce, Gaithersburg, MD, United States.
- Ortega-Vasquez, M.A., D.S. Kirschen and D. Pudijianto (2006), “Optimising the Scheduling of Spinning Reserve Considering the Cost of Interruption”, *IEEE Proceedings, Generation, Transmission and Distribution*, September, Vol. 153, Issue 5, pp. 570-575.
- O’Sullivan, M.J. and J.W. O’Malley (1999), “A New Methodology for the Provision of Reserve in an Isolated Power System”, *IEEE Transaction on Power Systems*, Vol. 14, Issue 2, pp. 519-524.
- PB Power and IBM (2003), “Operational Capital Expenditure Requirements to Maintain the Integrity and Resilience of the Electricity Distribution Infrastructure in Great Britain”, PB Power/IBM report for the Electricity Association.

- Pike Research (2009), *Smart Grid Technologies: Networking and Communications, Energy Management, Grid Automation, and Advanced Metering Infrastructure*, Washington, D.C., United States. Available at [www.pikeresearch.com/research/smart-grid-technologies](http://www.pikeresearch.com/research/smart-grid-technologies).
- Poonpun, P. and W.T. Jewell (2008), “Analysis of the Cost per Kilowatt Hour to Store Electricity”, *IEEE Transactions on Energy Conversion*, Vol. 23, No. 2, June, pp. 529-534.
- Rebours, D. and Y. Kirshner (2005), *A Survey of Definitions and Specifications of Reserve Services*, October 2005, University of Manchester, United Kingdom. Available at: [www.eee.manchester.ac.uk/research/groups/eeps/publications/reportstheses/aoe/rebours%20et%20al\\_tech%20rep\\_2005B.pdf](http://www.eee.manchester.ac.uk/research/groups/eeps/publications/reportstheses/aoe/rebours%20et%20al_tech%20rep_2005B.pdf).
- Rogers (2002), *Strategy, Value and Risk – The Real Options Approach: Reconciling Innovation, Strategy and Value Management*, Palgrave, London.
- Ruddell, A. (2003), “Investigation on Storage Technologies for Intermittent Renewable Energies: Evaluation and Recommended R&D Strategy”, INVESTIRE-NETWORK, Storage Technology Report: WP-ST6 Flywheel, CCLRC Rutherford Appleton Laboratory, Chilton, United Kingdom. Available on [www.itpower.co.uk/investire/pdfs/flywheelrep.pdf](http://www.itpower.co.uk/investire/pdfs/flywheelrep.pdf).
- Ruiz, P.A. and P.W. Sauer (2008), “Spinning Contingency Reserve: Economic Value and Demand Function”, *IEEE Transaction on Power Systems*, August, Vol. 23, Issue 3, pp. 1071-1078.
- Schlabbach, J. and K.-H. Rofalski (2008), *Power System Engineering: Planning, Design and Operation of Power Systems and Equipment*, John Wiley & Sons, Ltd, West Sussex, United Kingdom.
- Streiffert, D. (1995), “Multi-area Economic Dispatch with Tie Line Constraints”, *IEEE Transaction on Power Systems*, November, Vol. 10, Issue 4, pp. 1946-1951.
- TERNA (2004), *Codice di trasmissione, dispacciamento, sviluppo e sicurezza della rete*, TERNA, Roma, Italy.
- TERNA (2008), *Dati provvisori di esercizio del sistema elettrico nazionale*, TERNA, Roma, Italy.
- TERNA (2009), *Piano di sviluppo 2009*, TERNA, Roma, Italy.
- Tianshu, Bi, Sumei Liu, Zhenyu Huang and N. Hadjsaid (2010), “The Implication and Implementation of Smart Grid in China”, Power and Energy Society General Meeting, 2010 IEEE, 25-29 July, pp. 1-5.
- Tröster, E., R. Kuwahata and T. Ackermann (2011), *European Grid Study 2030/2050*, Energynautics, Langen, Germany.
- Van Hertem, D. and M. Ghandhari (2011), “Multi-terminal VSC HVDC for the European Supergrid: Obstacles”, *Renewable and Sustainable Energy Reviews*, Vol. 14, Issue 9, pp. 3156-3163.
- Van Roy, J., S. De Breucker and J. Driesen (2011), “Study on the Availability Analysis and Energy Consumption of Electric Vehicles”, EEVC-2011, European Electric Vehicle Congress, 26-28 October, Brussels, Belgium.
- Vande Meerssche, B., G. Van Ham, D. Van Hertem and G. Deconinck (n.d.), “Potential of Demand Side Management for Balancing: Analysing Loads”, working paper, K.U. Leuven, Belgium.



## Chapter 7

# Modelling the system-wide interaction of nuclear power and renewables: a case study of Germany<sup>1</sup>

### 7.1 Objective and background of this analysis

The preceding chapters discuss the nature of the system effects of power generation options and compare the system effects of nuclear energy to those of other technologies, especially of intermittent renewables. Instead of focusing on the system costs (plant-level costs, connection and reinforcement costs, short-term balancing and long-term adequacy provision) of a specific technology or of generation options, this chapter focuses on the characteristics of the electricity system. The main objective of this case study is to identify the overall supply costs of a electricity system with different generation portfolios, characterised by different shares of renewables as well as nuclear energy in the generation mix. In all scenarios, the system is designed to supply electricity to final consumers at a given load and with the same high level of reliability of supply. This approach is similar to the one adopted in previous chapters and, by and large confirms the results in Section 4.2, which were derived by a different methodology.

A specific focus of the present analysis is on the interaction of nuclear energy and intermittent renewables. The case study analyses in depth, with the help of a highly detailed and sophisticated quantitative model, a reference electricity system with properties similar to that of Germany. The study then assesses the impact of different level of renewables and nuclear on the whole electricity system. In addition to the required generating capacities, the model calculates storage capacities, reinforcement and extension of the distribution and transmission grids, wholesale electricity prices and electricity supply costs. Besides power generation costs, electricity supply costs include balancing costs, costs for the provision of adequate back-up capacities as well as additional costs for grid connection and reinforcement caused by the accommodation of renewables. With regard to environmental externalities, climate change externalities are taken into account using a fixed price for CO<sub>2</sub> emission allowances.

### 7.2 Methodology and presentation of the model

The definition of electricity supply costs used in this case study (“electricity supply costs are the costs of an electricity system as a whole that are caused in order to cover electricity demand during one year with a given high reliability of supply”) is coherent with the broader definition adopted throughout the whole report. It encompasses *all* cost components due to electricity generation, storage as well as transmission and distribution. Hence, the methodological approach taken to calculate the total costs of electricity supply is to determine and include the costs of all necessary components of an electricity system that are required for a reliable supply of the demand load.<sup>2</sup>

The electricity system described in the present case study has properties similar to the German electricity system: it is thus a relatively large system, with an annual load of 550 TWh. This system is considered as isolated, without the possibility to exchange power and to trade electricity with neighbouring electricity systems. Thus, the given electricity demand has to be covered by electricity generation within the electricity system.

1. Chapter 7 is based on a study contributed to the work of the WPNE by Rüdiger Barth, Heike Brand, Jürgen Apfelbeck and Alfred Voß from the Institute for Energy Economics and the Rational Use of Energy, University of Stuttgart.

2. All price and cost figures are in 2007 euros.

In order to assess the influence of varying shares of nuclear power and renewable energies on total supply costs, the case study provides several scenarios with different shares of renewable power production in the annual electricity demand in combination with varying installed capacities of nuclear power plants. In all scenarios, the same electricity demand has to be covered with equal reliability of supply.

The methodological approach to determine investment and operational costs due to electricity generation is based on fundamental electricity system modelling. Two models are subsequently employed:<sup>3</sup>

- The European Electricity Market Model (E2M2s) allows determining the required investments into generation capacity of conventional power plants and the cost optimal share of individual generation technologies. The intermittency of variable renewable energies is appropriately taken into account with the help of stochastic programming. For this case study, electricity generation based on renewable energies as well as the installed capacities of nuclear power plants are exogenously given for the various scenarios. The model thus optimises the shares of dispatchable power plants, considering hard coal-fired power plants, natural gas-fired combined cycle gas turbines (CC) and open cycle gas turbines (GT) as available investment options. In addition to meeting the electricity load, the provision of heat from combined heat and power (CHP) power plants is taken into account in the optimisation process. The determination of the cost optimal power plant portfolio is based on a detailed modelling of the technical restrictions of unit commitment and dispatch. As commonly done in this type of analysis, one calendar year is described by 144 representative time segments in order to reduce the computational effort.<sup>4</sup> Additionally, hours with extreme situations, i.e. extreme peak load and lowest residual load are modelled.
- For a more detailed determination of the electricity system operation, the Joint Market Model (JMM) is applied in a second step. This model takes into account the entire portfolio consisting of power plants and storage as determined in the first modelling step and derives the cost optimal unit commitment and dispatch with an hourly time-resolution for a whole calendar year. The hourly time-series of the electricity demand and of the generation pattern of renewable energies are based on historical time-series.

For this case study it is assumed that, with constant electricity demand, the present transmission and distribution grid is sufficient to accommodate the electricity generation of nuclear and conventional power plants. Hence, no further reinforcement of the transmission and distribution grid is needed in the scenarios with a low level of variable renewables. However, with higher shares of variable electricity generation of on- and offshore wind power plants far from load centres, further reinforcements of the transmission grid are needed.

This is particularly relevant for the German electricity system, where electricity generation of wind power plants is concentrated in the northern part of Germany whereas a main part of the load is located in the south. This leads to a need to strengthen the transmission lines from north to south (TransnetBW, 2012). Further on, wind onshore and photovoltaic power plants are mainly connected to voltage levels of the distribution grid. The electricity generation of these power plants induces costs due to reinforcements of the distribution grid mainly caused by an inadmissible increase of the supply voltage. The additional transmission and distribution grid costs which depend on the installed capacities of wind and photovoltaic power plants are based on costs values derived by studies determining the required grid reinforcements due to increasing contributions of renewable energies to electricity supply (EC, 2011; Dena, 2010a; BDEW, 2011).

3. A more detailed description of both fundamental electricity system models is given in Appendix 7.A.

4. The 144 representative time segments are based on six typical months (January/February, March/April...), two typical days (weekday, weekend day), twelve typical hours (0/1, 2/3, 4/5...).



### 7.3 The case study

This case study considers 12 different scenarios, resulting from a combination of 3 installed capacities of nuclear power plants and of 4 different shares of electricity generation based on renewables. The first section gives a more detailed description of the scenarios considered as well as of the cost assumptions. The following section will analyse the residual load that must be covered by dispatchable power plants as a function of different share of variable renewables into the generation mix. Then the optimal generation mix and the electricity production breakdown are described for each scenario. The last sections will report on the total cost of electricity supply, wholesale electricity prices and annual CO<sub>2</sub> emissions. Finally, a parametric study will analyse a scenario where the annual electricity produced by solar and wind technologies is reduced by 15% with respect to normal. Results of this parametric study are reported in Appendix 7.B.

#### Description of the scenarios

The 12 scenarios analysed in this case study and the acronyms used throughout this chapter are shown in Table 7.1. With regard to installed capacities of nuclear power plants, three cases are considered, corresponding to a capacity of 0, 20.7 and 41.4 GW, respectively. One option, labelled “NUCL-21”, corresponds to the nuclear power plant portfolio operated in Germany before the moratorium of seven nuclear power plants after the Fukushima Daiichi accident. A second option, labelled “NUCL-0”, describes a situation without nuclear energy, while a third one (“NUCL-41”) assumes a doubling of the actual nuclear capacity. Three of the four different renewable scenarios reflect the targets of renewable energy penetration set by the German energy policy for the years 2020, 2030 and 2050. The renewable shares are 35%, 50% and 80%, respectively. A further scenario assumes a share of 15% of electricity generation from renewables.

In order to avoid possible confusions, it has to be noted that the previous chapter focused mainly on variable renewables, i.e. wind and solar. In this case study the definition of renewables encompasses both variable and dispatchable renewable sources and thus includes also biomass and hydro production. For instance, the scenario with 15% of renewables does not contain variable electricity generation from wind and PV power plants, while the share of variable renewables in the other three scenarios is of 22%, 35% and 62%, respectively. Table 7.2 summarises for the different scenarios the individual shares of dispatchable and variable renewables in the annual electricity demand. Moreover, RES-15% scenario contains the same amount of electricity generation from dispatchable biomass and hydropower as the RES-50% scenario. By comparing the outcomes of those two scenarios it is possible to quantify the additional effect on variable renewables.

Figure 7.1 shows the generation mix of different renewable sources for the four configurations considered in this study; the installed renewable capacity is represented on the left figure while the net electricity generated is provided on the right one. It can be seen that the scenarios with higher shares of renewables are dominated by wind and PV power plants.

Tables 7.3 and 7.4 provide the investment and fuel costs assumption for generation and storage. Those values apply for all scenarios analysed in this case study. For hard coal and natural gas, prices are based on the projections of the *World Energy Outlook 2010, New Policies Scenario* (IEA, 2010). The assumed price for CO<sub>2</sub> emission certificates is set to EUR 50/t CO<sub>2</sub> in all scenarios. Finally, an interest rate of 7.5% is used in the calculations. All scenarios consider the possibility to use batteries of electric vehicles as storages for the electricity system according to the vehicle-to-grid concept (V2G). It is assumed for the future that available electric vehicles provide a total storage capacity of 48 GWh and a total loading/unloading power of 48 GW to the electricity system.

The specific grid reinforcement costs due to the accommodation of renewable electricity generation are estimated on the basis of the study *European Energy Roadmap 2050* (EC, 2011), the *Dena Study II* (Dena, 2010a), and a German study on the required distribution grid reinforcement (BDEW, 2011). For this purpose, the stated capacity increase of wind and PV power plants is divided by the increase of the stated grid reinforcement costs or the difference of the stated grid costs. With this approach, reinforcement costs of EUR 400/kW<sub>PV and Wind (on- and offshore)</sub> for the transmission grid and of EUR 500/kW<sub>PV and Wind (onshore)</sub> for the distribution grid are derived. No additional costs for information and communication technologies which are required for the implementation of smart grids are explicitly considered.

**Table 7.1: Scenarios analysed**

Installed capacities of nuclear power plants/share of renewables	0 GW	20.7 GW	41.4 GW
15%	RES-15%_NUCL-0	RES-15%_NUCL-21	RES-15%_NUCL-41
35%	RES-35%_NUCL-0	RES-35%_NUCL-21	RES-35%_NUCL-41
50%	RES-50%_NUCL-0	RES-50%_NUCL-21	RES-50%_NUCL-41
80%	RES-80%_NUCL-0	RES-80%_NUCL-21	RES-80%_NUCL-41

**Table 7.2: Shares of fully dispatchable and variable renewables in the annual electricity demand**

Total share of renewables	Share of fully dispatchable renewables	Share of variable renewables
15%	15%	0%
35%	13%	22%
50%	15%	35%
80%	18%	62%

**Table 7.3: Investment costs of power plants and pump storages**

Technology	Investment costs (EUR/kW)
Nuclear	2 700
Hard coal (condensing)	1 300
Hard coal (CHP)	1 678
Natural gas CC (condensing)	700
Natural gas (CHP)	975
Natural gas GT	325
Biomass	2 350
Hydro	3 500
PV	1 700
Wind onshore <sup>a</sup>	1 200
Wind offshore <sup>a</sup>	3 670
Pump storages <sup>b</sup>	509

a) These cost assumptions include costs due to the connection of the power plant to the grid.

b) Plus an additional EUR 4.6/kWh<sub>Storage\_capacity</sub>.

**Table 7.4: Fuel prices for all scenarios**  
(including transportation costs to power plant)

Fuel	Price (EUR/MWh)
Nuclear fuel	3.6
Hard coal	10.1
Natural gas	36.1

**Figure 7.1: Renewable energies for the different scenarios:  
a) installed capacities and b) annual electricity generation**

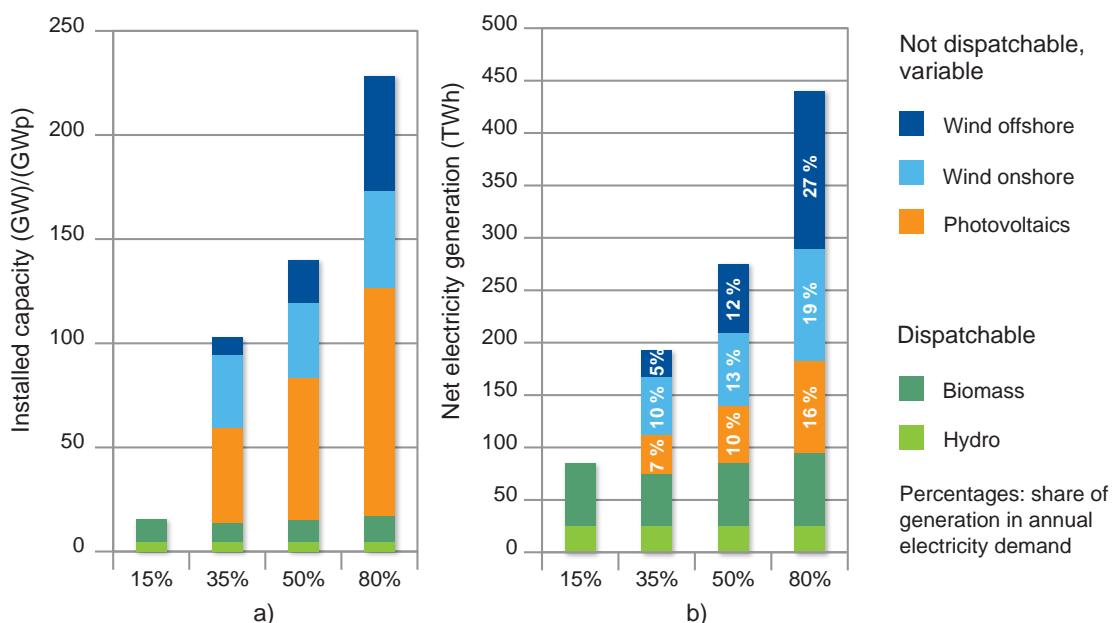

#### *Residual load and required storage capacity with high shares of renewables*

For each scenario, a projection of the residual load is computed on the basis of historical hourly time-series of demand load provided by ENTSO-E (2012) and of the electricity generation by the different variable renewable energies (EEX, 2012).<sup>5</sup> The total demand load and the residual load for the scenarios with a 50% and an 80% share of renewables are reported in Figure 7.2.

In general, residual load is lower and more volatile than total demand load. A striking feature is that the traditional daily, weekly and seasonal patterns of the demand load are no longer reflected in the residual load, which is dominated by the variability of renewable generation. Other important aspects that are discussed in the following are the maximal residual load to be covered by dispatchable technologies, the frequency of periods in which production from variable renewables exceeds the load, as well as the amplitude and gradient of the fluctuations of the residual load.

Despite a considerable deployment of renewable capacity, the maximal load to be covered by conventional power plants does not strongly decrease due to the low capacity factors of variable renewables. Compared to a maximal demand of about 88 GW, the maximal residual load in the scenario with a 50% renewable share still adds up to 75 GW and in the scenario with an 80% renewable share to 71 GW.

With the increase of variable renewables into the generation mix, there are frequently periods in which the electricity generated from renewables exceeds demand and the residual demand thus becomes negative. The extent of such excess of production increases significantly with the penetration level of variable renewables. The scenario with a 50% share of renewables leads to an excess renewable power of up to 27 GW. The annual renewable surplus of electricity generation amounts to approximately 2 TWh, which is about 1% of the annual electricity generation by wind and PV power plants. In the scenario with an 80% share of renewables, the maximal excess renewable power increases to 78 GW. The annual renewable surplus electricity generation significantly rises, up to approximately 43 TWh, which is equal to approximately 12% of the annual electricity generation by wind and PV power plants.

5. The residual load is equal to the demand load minus the electricity generation based on renewable energies and has to be covered by dispatchable power plants and storage.

Variable electricity generation based on renewable energies significantly affects the maximal amplitude of residual load variations as well as the gradient of those changes (ramp rates). These effects are increasingly severe with the penetration level and make more and more challenging the balancing of the electricity system by dispatchable generators and storage capacities.

The amplitude of load changes increases as well with increasing shares of renewables. For the current demand, the maximal amplitude of the demand load amounts to about 30 GW: the maximal negative amplitude being of -32 GW and the maximal positive amplitude of +33 GW. In the scenario with 50% of renewables (35% of variable generation), the maximal amplitude of the residual load almost doubles, reaching the values of -57 GW and +58 GW. The maximal load oscillations reach the impressive value of 100 GW within a time period of few hours in the 80% scenario, where variable sources constitute about 62% of the electricity generation. In addition, these large power variations in the residual demand occur in a very short time frame of few hours. Figure 7.3 shows the amplitude changes for three situations described above.

The increasing challenge for balancing the system appears also when comparing the required gradient of residual load changes (ramp rate). If one considers the current demand curve, the maximal hourly gradient is of between -7.6 GW/h and +12 GW/h. Also, less than 9% of the gradients exceed the range of  $\pm 5$  GW/h. In the scenario with 50% renewables, gradients are between -12.6 GW/h and +14.6 GW/h, and the fraction of gradients larger than  $\pm 5$  GW/h is doubled to 18%. With an 80% share of renewables, the extent of the hourly gradients significantly rises. The maximal positive and negative hourly gradient exceeds the value of 20 GW. Approximately only two thirds of the hourly gradients remain between  $\pm 5$  GW/h, while gradients exceeding  $\pm 10$  GW/h occur in 7.5% of the cases. The major part of this phenomenon can be attributed to the increasing share of electricity generation based on PV power plants.

If the electricity generation is to be based increasingly on renewable energies, sufficient storage capacity is needed in the system and has to be developed. The 50% renewable scenario requires a total storage capacity of approximately 250 GWh. The total storage capacity presently available in the German electricity system amounts only to approximately 40 GWh (Dena, 2010b; Hartmann *et al.*, forthcoming). However, if one considers additional pump storage that is currently being planned and likely to be built as well as drawing rights to pump storage abroad, a total storage capacity of approximately 400 GWh can be assumed. This is sufficient for the three scenarios with a 15%, 35% and 50% share of renewables.

In the 80% renewable scenario, however, the required annual storage capacity dramatically increases to 6 400 GWh (6.4 TWh). Yet most of this capacity is needed only during a comparable low number of hours (see Figure 7.4), which in combination with the massive decline of electricity prices is the reason why storage is more economical than dispatchable capacity under these circumstances. In those conditions, a selective curtailment of electricity generated by variable renewables would reduce the need for large storage capacities and hence lead to lower total electricity system costs. Hence, the model determines cost-optimal storage capacity in combination with curtailment of renewable power generation in the 80% renewable scenarios.<sup>6</sup> Based on this analysis, a cost-optimal storage capacity of 4.2 TWh with a maximum load of 54.8 GW is derived.

### *Structure and operation of power plant and storage portfolios*

The resulting generating portfolios in the 12 different scenarios analysed are reported in Figure 7.5.<sup>7</sup> As already mentioned, the installed capacities of renewable energies, nuclear power and storage are determined exogenously.<sup>8</sup> Then, the capacities for conventional coal- and gas-fired power plants are optimised for each scenario using the E2M2s.

6. The cost-optimal storage capacity is determined with the JMM programme. Based on the power plant portfolio derived with E2M2s and different levels of storage capacity, JMM determines the optimal level of storage by minimising the system operation costs, given by the investment costs on storage and the operating costs of the entire electricity system.

7. The assumed generation capacity of mobile batteries of electric vehicles of 48 GW, which is considered for all scenarios, has not been included in the figure

8. The method used for determining optimal capacity storage has been described in the section above.

With the assumed composition of renewables in the different scenarios, the sum of total installed capacity increases significantly with rising shares of renewables, from approximately 110 GW for a 15% renewable share up to more than 340 GW for an 80% renewable share. Furthermore, comparable amounts of conventional power plant capacity are required in all scenarios due to the modest capacity credit of variable renewables. Hence, renewables do not significantly replace conventional power plants. On the basis of the approach chosen to determine the cost-optimal storage capacity in the scenarios with an 80% renewable share, the installed power of pump storages increases approximately by factor five in comparison to the scenarios with lower shares of renewables.

For the scenarios with a 15% share of renewables without variable wind and solar power, coal-fired power plants are favoured over gas-fired power plants. With higher shares of renewables mainly based on variable wind and PV, natural gas-fired power plants with higher operational flexibility are becoming more important in the total conventional power plant portfolio. In the scenarios with a doubled nuclear power plant portfolio, the absolute capacity of gas-fired power plants is considerably decreased, since the large installed nuclear capacity is capable to provide a major share of the required flexibility to the system. Finally, in all scenarios with an 80% share of renewables, open cycle gas turbines are no longer part of the optimal portfolios as the large pump storage capacity can supply all the fast flexibility needed by the system.

Annual electricity production in the different scenarios is shown in Figure 7.6.<sup>9</sup> Without surprise the total electricity produced by renewable increases with their penetration level. However, with increasing penetration of wind and solar plants, the curtailment of variable power plants becomes significant. For instance, with a 35% and 50% share of renewables, the curtailment of electricity generation from wind and PV power plants is negligible and amounts to maximal 0.4% of the possible annual electricity generation. The annual curtailment of variable renewables notably rises to approximately 9% of the possible annual generation in the 80% renewable scenarios, due to limited storage capacity. Thus, in those scenarios renewables can effectively contribute only 74% of the annual electricity demand.

If one considers Germany's nuclear capacity before the recent phase-out decision (21 GW), the introduction of renewables up to 35% penetration does not have important consequences on nuclear power production. Total electricity generated by nuclear remains roughly constant in these scenarios, with full load hours of nuclear reducing only from 7 900 to 7 700 hours. With a 50% share of renewables, the electricity generated by nuclear power plant decreases by about one eighth, while it is more than halved in the 80% renewable scenario, where only 3 750 full load hours are achieved.

In the scenarios with doubled capacity of nuclear power plants (41 GW), the decline of the total annual nuclear electricity generation with increased share of renewables is comparatively stronger. In the scenario with a 15% renewable share and without variable renewables, nuclear power plant portfolio shows about 7 600 full load hours and covers approximately 57% of annual power generation. Full load hours decrease with renewable penetration to reach a minimum of about 2 500 hours in the 80% scenario. The economical competitiveness of nuclear in such market conditions appears quite limited.

The electricity generation based on fossil fuels is dominated by coal-fired power plants. As observed for nuclear baseload capacity, full load hours of hard coal-fired power plants are decreasing with higher share of renewables (and nuclear). However, the reduction of electricity production from coal is less pronounced because part of coal power plants in operation are also used for heat supply.

Unsurprisingly, the annual electricity generation and full load hours of combined cycle gas turbines tend to drop with increasing renewable and nuclear power generation. The full load hours reach maximal ca. 7 400 hours in the scenario with a 15% renewable share and no nuclear power and reach a minimal value of about 500 hours in the scenario with an 80% renewable share and doubled nuclear power plant portfolio. Interestingly, at high variable renewable penetration level, the large flexibility required for balancing the fluctuation of wind and PV production is more economically obtained via pump storage and the contribution of gas power plants results rather limited.

9. The difference in total annual generation between the scenarios is due to the different use of pump storage for different generation mix.

**Figure 7.2: Comparison of electricity demand load and residual load for a) 50% and b) 80% share of renewable energies**

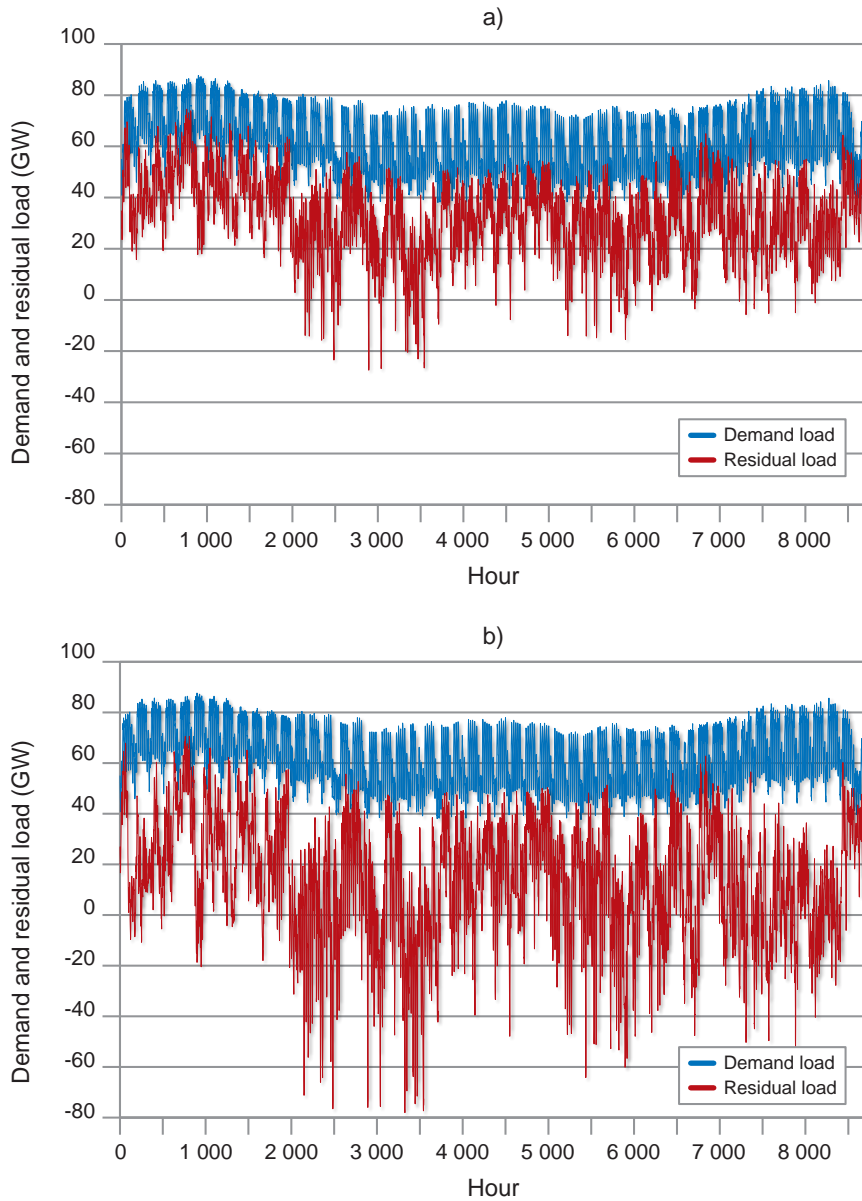

**Figure 7.3: Amplitude of changes of a) the demand load and the residual load in the b) 50% and c) 80% scenarios**

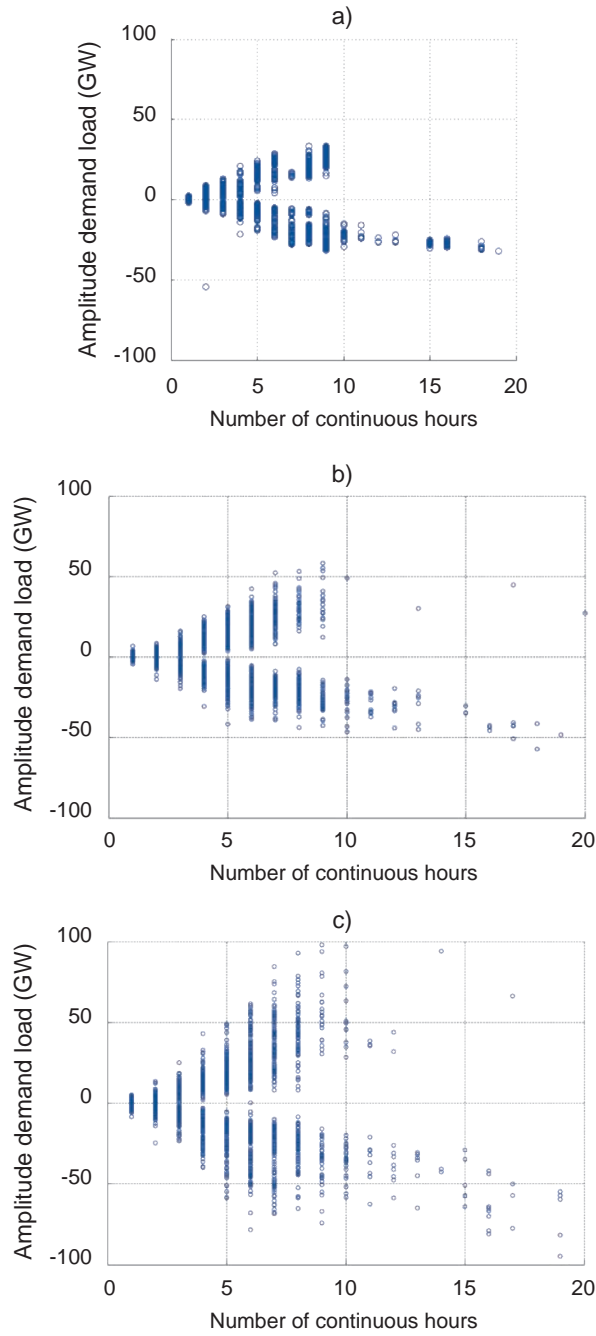

### Electricity supply costs

This case study confirms that electricity supply cost increases significantly with the share of renewable energy. A sizeable share of nuclear in the generation mix instead contributes to reduction of the overall cost of electricity supply. Table 7.5 reports the average electricity supply costs for the different scenarios considered. Additional information is provided in Figure 7.7, which visualises the individual cost components of total electricity cost.

The least cost scenario does not include any variable wind and solar power, and has the highest nuclear capacity considered. In this scenario (RES-15%\_NUCL-41), the total electricity supply cost is EUR 39 billion, which corresponds to an average cost of EUR 71/MWh. With increasing shares of renewables, the electricity supply costs increase as well. The scenario featuring the highest cost is the one with 80% of renewables and no nuclear. Here, electricity supply costs sum up to EUR 96 billion or EUR 174/MWh, about two-and-a-half times that the cost of the least-cost option. At high levels of renewables, the investment and fixed operating costs for renewables become the largest and dominant contribution to electricity supply costs. Costs for the additional reinforcement both of the transmission and distribution grid constitute also a considerable part of the increase in electricity supply costs. Investment for storage becomes also significant in the 80% scenario. The benefits arising from reduction in the costs for fuel and CO<sub>2</sub> emission certificates instead are limited.

For a given share of renewables in the system, electricity supply costs decrease with increasing capacities of nuclear power. This is due to a significant decrease of the costs for CO<sub>2</sub> emission certificates and fossil fuels. These differences are the largest in the 15% renewable case and the smallest in the 80% renewable case. In this latter scenario, electricity supply costs increase when nuclear capacity is at 41 GW, as savings in the costs for fuels and CO<sub>2</sub> emission certificates do not compensate the investment costs for the additional nuclear power capacity due to the limited number of full load hours of the nuclear power plants. However, if one considers that a portion of the nuclear power plant portfolio is entirely depreciated and can continue operations assuming retrofitting, the total costs of electricity supply decrease even with higher nuclear capacities in the 80% renewable scenarios [scenario RES-80%\_NUCL-41(21LE)] in Figure 7.7.<sup>10</sup>

**Figure 7.4: Duration curve of required storage capacity for the 50% and the 80% scenarios**

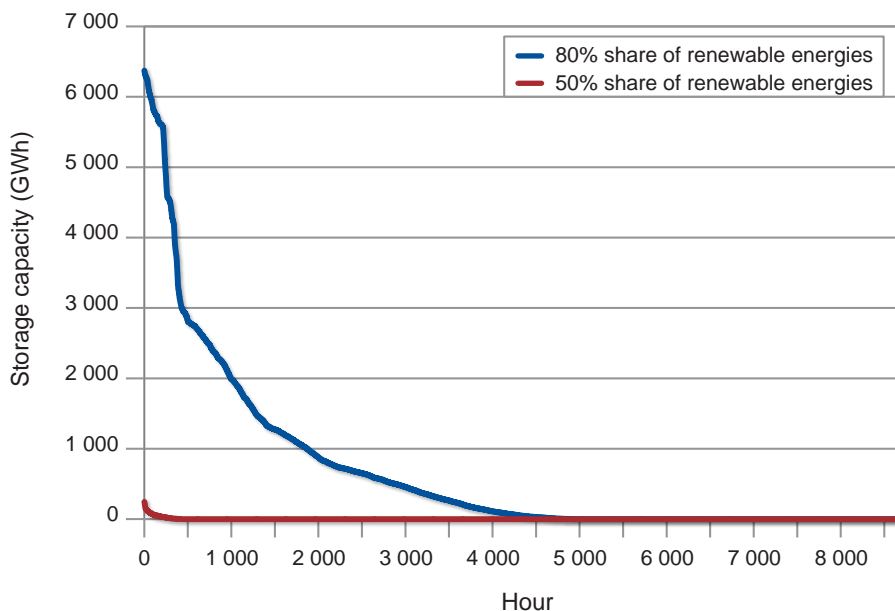

10. In this scenario, we have considered that half of the nuclear power plants can continue operations with a retrofitting cost of EUR 500/kW. The remaining 50% is new built, with the same investment cost assumed throughout this study (see Table 7.3).



**Figure 7.5: Installed power plant and pump storage capacities for considered scenarios with varying shares of renewables and varying installed capacities of nuclear power**

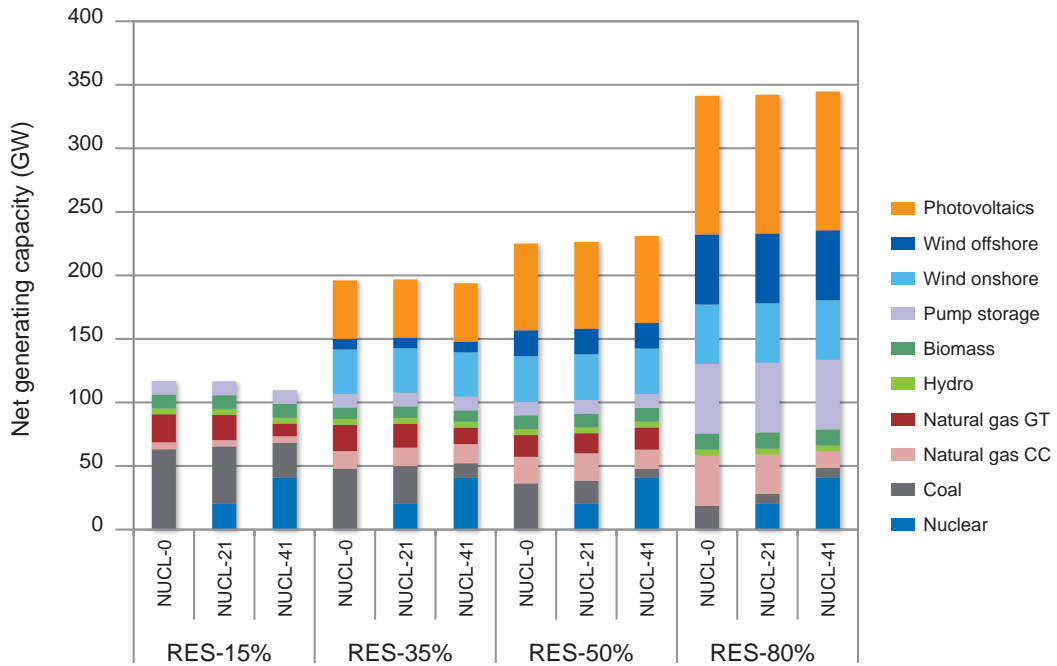

**Figure 7.6: Annual electricity generation for considered scenarios with varying shares of renewables and varying installed capacities of nuclear power**

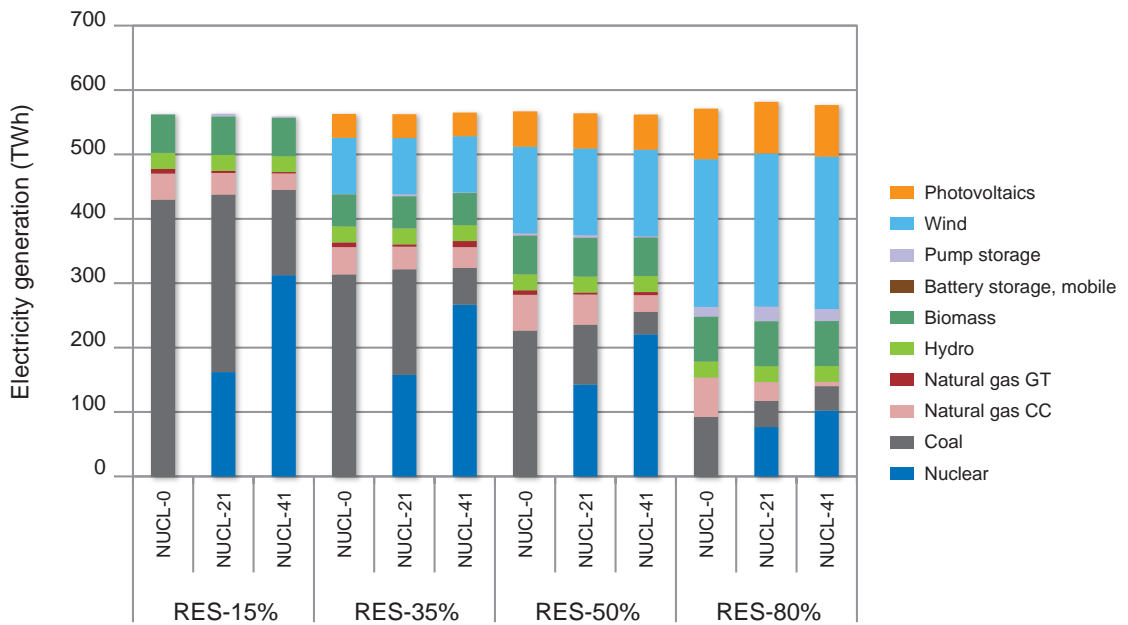
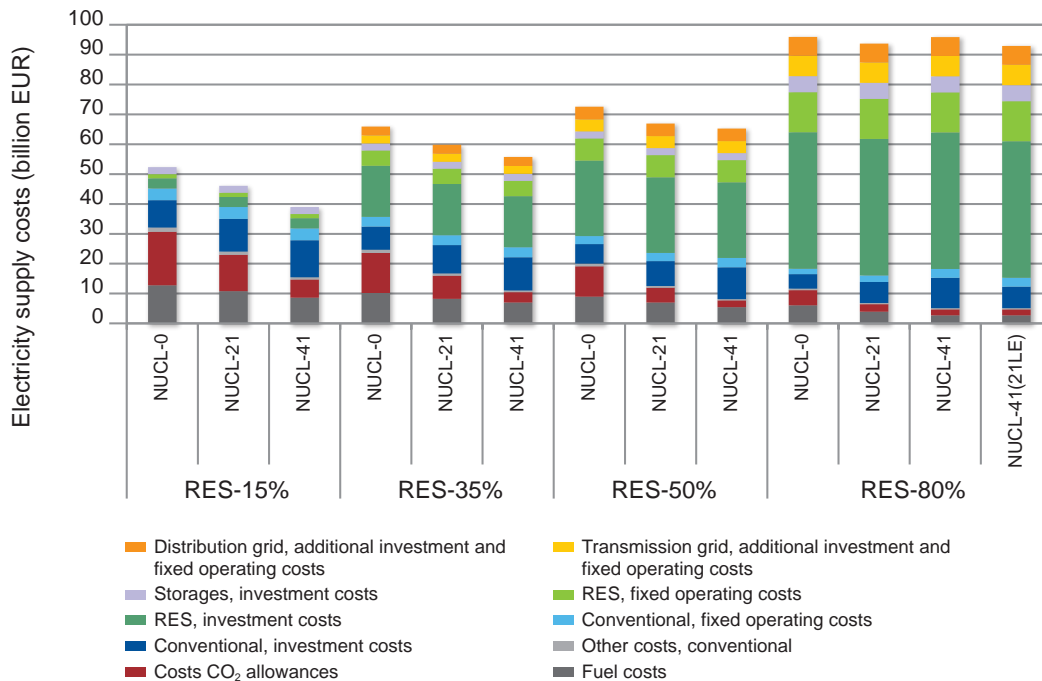

**Table 7.5: Electricity unit supply costs in EUR/MWh for considered scenarios with varying shares of renewables and varying installed capacities of nuclear power**

Installed capacities of nuclear power plants/share of renewables	(EUR/MWh)		
	0 GW	20.7 GW	41.4 GW
15%	95	84	71
35%	120	109	101
50%	132	122	119
80%	174	171	174 <sup>a</sup>

a) Variation RES-80%\_NUCL-41(21LE) with one half of the nuclear power plant portfolio being entirely depreciated but retrofitted: EUR 169/kWh.

**Figure 7.7: Annual electricity supply costs for considered scenarios with varying shares of renewables and varying installed capacities of nuclear power**



**Figure 7.8: Duration curves of wholesale electricity prices for scenarios with an installed nuclear power capacity of 20.7 GW (“NUCL-21”) and different renewable shares**

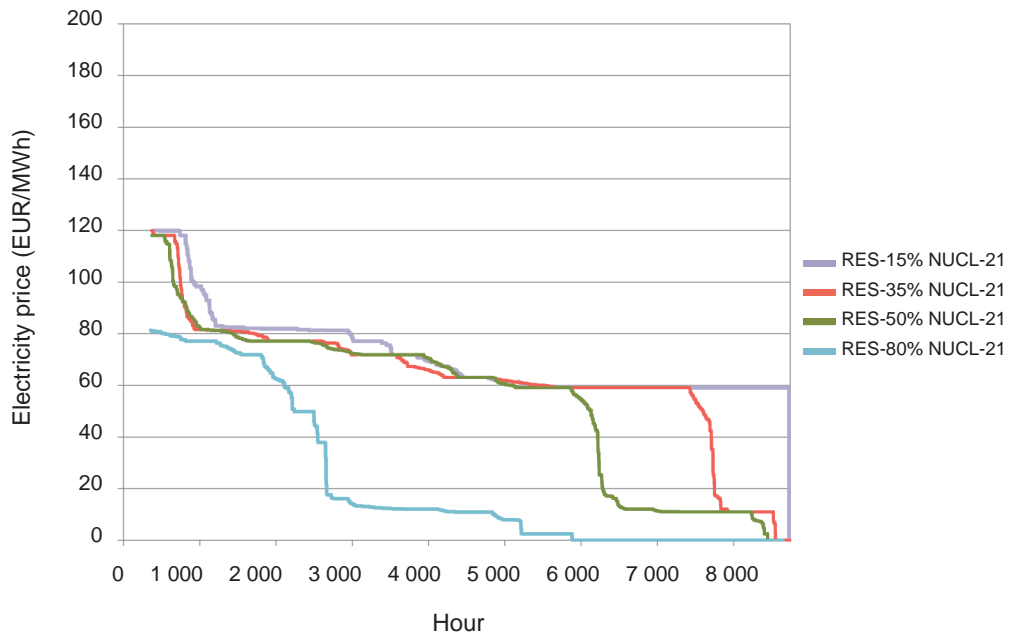

**Figure 7.9: Duration curves of wholesale electricity prices for scenarios with a 35% renewable share and different installed capacities of nuclear power**

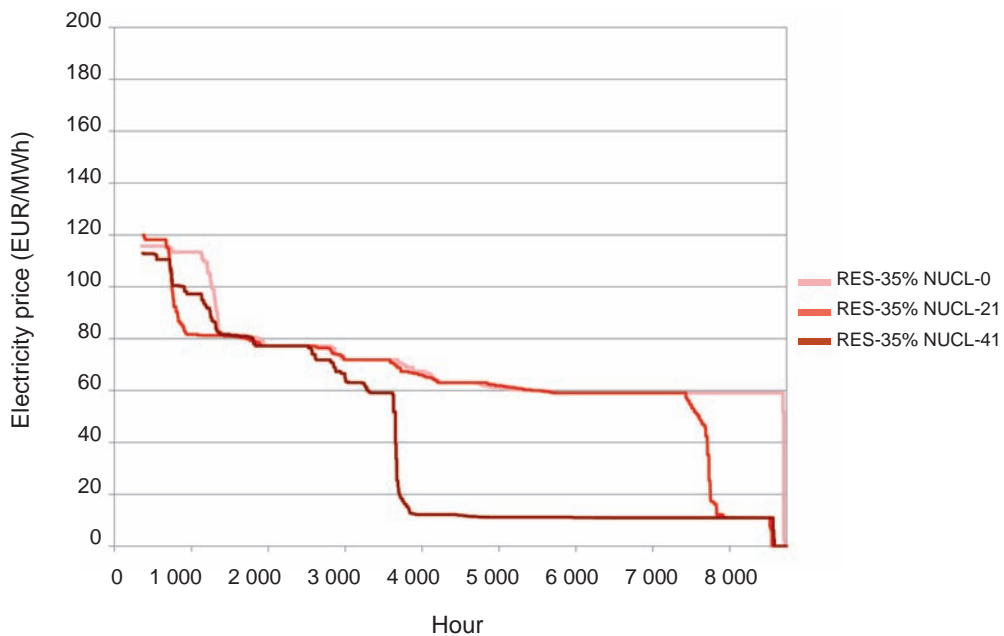

**Figure 7.10: Annual CO<sub>2</sub> emissions for considered scenarios with varying shares of renewables and varying installed capacities of nuclear power**

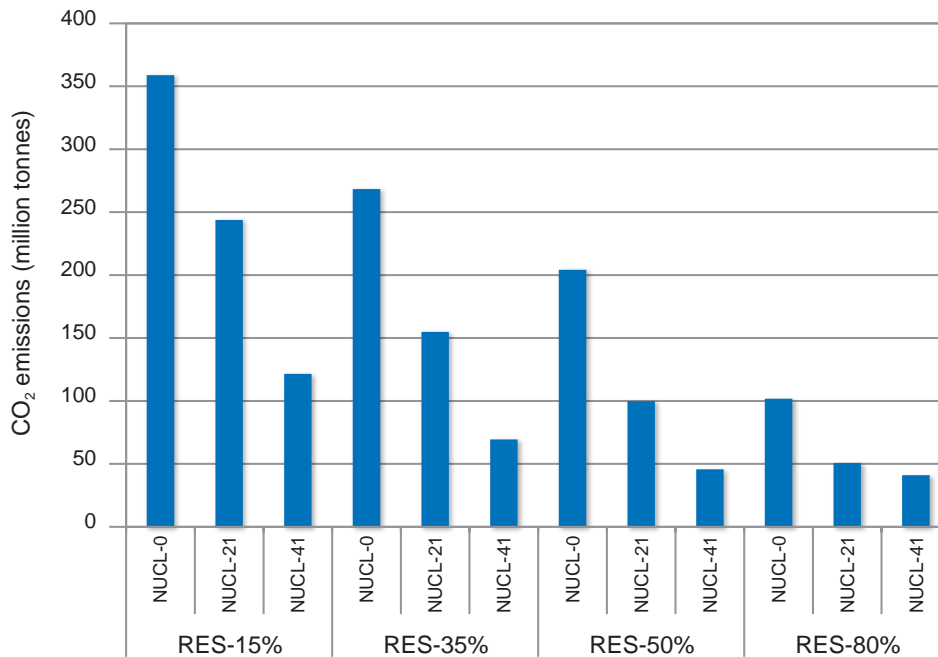

### Wholesale electricity prices

Wholesale electricity prices are calculated as a function of the variable costs of the marginal technology called upon. This reflects the price formation mechanism on electricity wholesale markets in most European countries. The price duration curves of electricity prices are shown in Figures 7.8 and 7.9. Figure 7.8 shows the duration curves of wholesale electricity prices for the scenarios with an installed nuclear power capacity of 21 GW but with different renewable shares. Figure 7.9 shows price duration curves for the scenarios with a renewable share of 35% and different nuclear capacities.

With increasing generation based on renewable energies, electricity prices are generally reduced. For the scenarios with a 35% and 50% share of renewables, the electricity price is equal to zero during a relatively low number of hours. In the scenario with an 80% renewable share, electricity prices are considerably lower compared to the other scenarios and the number of hours with electricity prices equal to or below zero rises to an astonishing 2 850 hours. A reduced occurrence of electricity prices higher than variable costs in combination with reduced utilisation hours means lower infra-marginal rents for recovering capital costs. Consequently, it is highly questionable whether conventional power plants can be profitably operated with high shares of renewables in energy-only markets with price formation being based on marginal costs. This study thus confirms the results of the compression effect analysis in Chapter 4.

As observed for renewable energies, also increasing nuclear capacity in the generation mix contributes to reducing wholesale electricity prices, as shown in Figure 7.9. Nuclear is the marginal technology for about 700 hours in the scenario with an installed nuclear power capacity of 21 GW. Doubling the nuclear share makes nuclear the marginal technology for 4 700 hours a year. In this latter scenario, wholesale electricity prices are below 20 euros per MWh more than 50% of the time.

### Annual CO<sub>2</sub> emissions

The carbon emissions of the different scenarios are calculated on the assumption of a uniform price for CO<sub>2</sub> emission certificates on the EU ETS of EUR 50/tCO<sub>2</sub>. Results are reported in Figure 7.10 for the 12 scenarios considered. As expected, both nuclear and renewable energy allows for a significant reduction of carbon emissions. Compared with the 359 million tonnes of CO<sub>2</sub> emitted in the scenario with 15% renewables and no nuclear, emissions are reduced to as low as 41 million tonnes in the scenario featuring the highest shares of nuclear and renewables.

Maintaining Germany's nuclear capacity at the pre-Fukushima Daiichi level would decrease carbon emission by at least 100 million tonnes in all scenarios considered, with respect to an option without nuclear. A higher share of nuclear capacity would enhance these reductions: a total of about 240 million tonnes of CO<sub>2</sub> would be saved in the 15% scenario, while avoided carbon emissions are about 199 and 158 million tonnes in the 35% and 50% renewable scenarios. Even in the scenarios with higher shares of renewables, nuclear power would allow halving carbon emissions compared to a scenario without nuclear.

If nuclear and renewable technologies both allow for a significant reduction in carbon emissions, they have opposite effects on the total cost of electricity supply. Increases in renewable energy lead to increases in total electricity supply costs. Nuclear is the only technology that reduces both carbon emissions and supply costs.

## 7.4 Summary

Based on two detailed, large scale energy system models, this case study determines the production mix, the electricity supply costs and the carbon emissions of an electricity system with different shares of renewable energies, in particular of variable wind and solar energies, in combination with different installed capacities of nuclear power.

With large installed capacities of variable power plants such as wind and PV, the residual demand to be covered by dispatchable conventional power plants becomes very variable. Also the electricity system must cope with extended periods of time in which the power from variable renewables exceeds the demand. Those conditions require a large degree of operational flexibility from dispatchable power plants and significant storage capacity in the system. However, even a large deployment of wind and solar capacity does not reduce significantly the total installed capacity of conventional power plants, due to the limited reduction of the maximal value of the residual load, which leads to low capacity credits.

In general it can be observed that renewable energies cause an increase of electricity supply costs whereas nuclear power leads to a decrease of electricity supply costs. The lowest annual electricity supply costs of EUR 39 billion are obtained in a scenario without any wind and PV power plants but with a high share of nuclear power. On the opposite side, maximal electricity supply costs are obtained for a renewable share of 80% in the annual electricity demand (wind and PV power plants contribute with 62% to the annual electricity demand) and no nuclear power plants. Annual electricity supply costs amount to EUR 96 billion per year, an increase of about 150% over the least-cost case.

The large increase of the electricity supply costs with higher shares of renewables is mainly caused by the investment costs of power plants based on renewable energies, their fixed operating costs, the balancing costs and the additional expenses for transmission and distribution grid reinforcements. The reduction of total supply costs in the systems featuring significant nuclear capacity is due mainly to less CO<sub>2</sub> emission certificates being needed and reduced fuel costs. A least-cost power generation portfolio would be characterised by a large nuclear power capacity and low shares of variable renewables. In particular, intermittent renewables are penalised by the high system costs required for their integration into the electricity system.

Wholesale electricity prices decrease with increasing shares of low marginal cost renewables. Electricity systems with very high renewable shares show electricity prices equal to or below zero during a high number of hours of a year. This price reduction, combined with reduced full load hours of conventional power plants, is a challenge for the profitability of operating conventional dispatchable power plants in market based on marginal variable electricity generation costs. Also increasing the share of nuclear power tends to reduce the wholesale electricity prices. Doubling the actual nuclear capacity would align electricity prices to the marginal costs of nuclear power plants during a substantial number of hours.

Both increasing shares of renewables and nuclear power capacities reduce the annual amount of CO<sub>2</sub> emissions. However, the decrease of the annual CO<sub>2</sub> emissions due to renewable energies comes with an increasing electricity supply costs leading up to additional EUR 170 per avoided tonne CO<sub>2</sub> in a scenario with an 80% renewable share and no nuclear power. On the contrary, high shares of nuclear in the generating mix allow obtaining significant reduction on the carbon emissions combined with a reduction of total electricity supply costs.

## Appendix 7.A

# Structure and working of the E2M2S and the JMM used in the modelling

### The European Electricity Market Model

The European Electricity Market Model (E2M2s) is a fundamental bottom-up electricity market model that determines the cost optimal investment decisions into different power plant and storage technologies. The most innovative characteristics of E2M2s compared to classical investment models are the detailed consideration of operational constraints of individual thermal power plants with inter-temporal restrictions and the possibility to describe the fluctuations of wind power generation by the use of stochastic programming. In order to reduce the computational effort but still delivering a satisfactory modelling quality, E2M2s uses typical hours giving the basis for the determination of the cost optimal demand coverage during a whole calendar year.

#### Construction of typical hours

Generally, power generation shows certain seasonal similarity among hours, days and months, as a result of similarity in the state of crucial factors, e.g. electricity and heating load, temperature and brightness. Every two neighbouring months are represented by a typical month, while the working days from Monday to Friday are merged into a single week day, and Saturday to Sunday into a weekend day. Correspondingly, every two consecutive hours are aggregated into one representative hour. As a result, 8 760 hours of one calendar year are represented by constructed 144 typical hours in total.

Technical constraints of thermal power plants are relevant not only within discrete time points but also during continuous time sequences, particularly if inter-temporal constraints are considered. For this purpose, an algorithm is developed to identify all possible time sequences between the constructed typical hours.

#### Structure of E2M2s

To simultaneously optimise the investment decisions into new power and storage plants and the unit commitment and dispatch, E2M2s is usually applied on an annual basis. The optimisation objective is to minimise the sum of investment costs of conventional power plants and storages described with annuities, annual operating costs and relevant fixed costs.

#### Investment options

In E2M2s, investment options include only thermal power plants and storages. The installed capacities of renewable energies, and for this study as well of nuclear power plants, are exogenously given. Each investment option must be characterised by its technical data (used fuel, net installed capacity, energy efficiency, etc.) and economic parameters (investment costs, fixed operating costs, etc.). When mixed-integer programming is applied, investment decisions can only be made in entire power plants, which means that the installation of partial capacities is not allowed.

#### Unit commitment and dispatch

The cost optimal unit commitment and dispatch determined with E2M2s has to ensure a reliable supply of electricity and district heat, which means fully coverage of the given electricity and heat demand load

at all typical hours and provision of sufficient reserve capacities as well. The requirements for reserves primarily depend on the generation structure of the supply system. It is calculated on the basis of probabilities of unscheduled power plant outages and the stochastic short-term forecast errors of wind power generation. A cost optimal allocation of the reserve provision to single generation units is part of the unit commitment and dispatch.

The unit commitment and dispatch determines the generation status of each power and storage plant and its load in each typical hour. The generation status of a power plant can be differentiated between online when it is generating and offline otherwise. Based on the time-dependent generation status, inter-temporal constraints like start-up times, minimum online or offline times and fill levels of storages are considered. The actual load of a power plant can vary between the installed net capacity adjusted by its technical reliability and a defined minimum load. Moreover, the decrease of the efficiency during part load operation and the corresponding increased specific fuel consumption are taken into account as well.

Heat demand is covered by CHP units which produce electricity and heat simultaneously. In E2M2s, two types of CHP plants are considered. While extraction-condensing CHP units provide to a certain extent a flexible ratio of electricity and heat output, back pressure CHP can produce electricity and heat only at a constant ratio. Regarding these constraints, a feasible operation area is described for each CHP unit by further model restrictions. In contrast to electricity, heat can efficiently be delivered only within a relatively short distance. Therefore, CHP units are allocated to individual heat regions. Heat delivery between different heat regions is not allowed.

### Stochastic modelling of wind power

Electricity generation of photovoltaic and wind power is considered as privileged generation that has to be accommodated into the electricity system. Due to its variable and limited predictability, the growing share of wind and solar power in the generation portfolio imposes challenges on the unit commitment and dispatch of conventional power plants. To maintain the reliability of the power system to cover the load, a more flexible operation of conventional units is required. In order to properly model the uncertainties of wind power, a scenario grid is constructed based on a cluster analysis of historical data. Figure 7.1A illustrates a simplified scenario grid describing the stochastic wind power generation. With a constant number of scenarios at each time step, the constructed scenario grid remarkably reduces the computational effort compared to traditional scenario trees. Along the time steps, the magnitude of the wind power generation is categorised into three levels (low, medium, high), represented by three nodes. Wind intensity and probability of occurrence are matched to each node of the scenario grid. In addition, transition probabilities between the individual nodes of two subsequent time stages are considered: a transition probability describes the probability that a high wind level is followed in the subsequent time step by a high, medium or low wind level, respectively.

Figure 7.1A: Scenario grid for the modelling of stochastic wind power generation

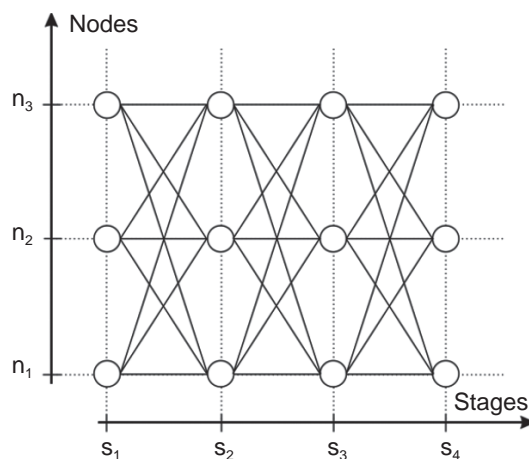



## The Joint Market Model

Based on a fundamental bottom-up approach, the Joint Market Model (JMM) determines the cost minimal unit commitment and dispatch of a given power plant portfolio. The modelling focus is the description of operational characteristics of each single unit, the time schedule of wholesale electricity trading at spot markets as well as the variable and not perfectly predictable electricity generation of renewable energies, in particular of wind power.

### Optimisation of system operation costs

Based on an hourly time resolution, JMM determines the cost optimal unit commitment and dispatch of power plants and storages to cover the electricity demand (and additionally the heat demand by CHP plants). The objective of the optimisation is to minimise the system operation costs of an electricity system given exogenously, for example determined by the use of E2M2s. The following cost components are considered in the objective function:

- *Fuel costs*: One main part of the system operation costs of electricity generation are caused by the fuel consumption of conventional power plants. The fuel costs are calculated based on the consumed fuel dependent on the operation mode of the units multiplied by the assumed fuel prices. However, the efficiency curve or the fuel consumption curve of a power plant is not linear. In order to avoid non-linearities in the numerical optimisation model, a piece-wise linear efficiency curve between the maximal and minimal load of a unit is defined.
- *Miscellaneous variable operational and maintenance costs*: In addition to the fuel costs, the operation of power plants also causes miscellaneous variable operational and maintenance costs, which are calculated from a technology-dependent parameter multiplied by the respective electricity generation.
- *Start-up costs*: The start-up process of generation units leads to additional fuel consumption and equipment abrasion. To calculate the start-up costs, the used fuel amount for start-ups is multiplied with the fuel price and a technology-dependent start-up cost parameter is considered.
- *Costs for the use of CO<sub>2</sub> emission certificates*: The costs for the consumption of CO<sub>2</sub> emission certificates are determined by multiplication of the required CO<sub>2</sub> emission certificates and the assumed certificate price. The required CO<sub>2</sub> emission certificates are calculated based on the fuel consumption multiplied with a fuel specific CO<sub>2</sub> emission coefficient.

### Unit commitment and dispatch restrictions of conventional power plants and storages

The optimisation of power plant and storage commitment and dispatch is subject to the operational restrictions of different unit types. To achieve a detailed modelling of the operation of power plants and storages, the optimisation can be formulated on the basis of mixed integer linear programming. A binary variable describes the start-up/shutdown status of every single power plant and storage. This enables an accurate description of inter-temporal restrictions as start-up, minimal operation and minimal offline times. The generation is however described by a continuous variable, whose value can vary between the installed net capacity and the minimal load. In order to avoid a high computational effort, the start-up/shutdown status can alternatively be described with a continuous variable based on a linear relaxation.

In addition to the coverage of the electricity demand, sufficient reserve capacity with a defined quality is a prerequisite for a stable system operation. Hence, the provision of reserve capacity is also a part of the unit commitment and dispatch optimisation. A predefined reserve capacity for operating and standing reserves has always to be maintained. Furthermore, the possible contribution of every single power plant to the operating and standing reserves is described by further technical restrictions in the model.

Pump storages and battery storages of electric vehicles are modelled under consideration of their charging capacity and their maximum and minimum storage capacities. The energy loss during the charging and discharging process is combined to a cycle efficiency of the storage which is considered during the charging process.

### Rolling planning

A substantial characteristic of JMM is the determination of cost optimal power plant and storage unit commitment and dispatch with consideration of short-term forecasts of electricity generation based on wind energy and electricity demand. For each planning period covering the horizon of one short-term forecast, one optimisation problem is defined. Yet, the consideration of one single short-term forecast is not sufficient for a comprehensive analysis of the annual unit commitment and dispatch of an electricity system. The determination of the optimal unit commitment and dispatch for a longer and continuous period is required. With the help of rolling planning, several optimisation periods are arranged successively. In the sequence of these single planning periods the time schedule of wholesale electricity trading at spot markets as well as the compensation of forecast errors are considered. The following planning sequence is applied:

- With every planning period starting at noon, a day-ahead scheduling for the hours of the following day according to the time structure on the day-ahead spot market for electricity is made. The future wind power production and electricity demand up to 36 hours ahead is considered. After optimisation, the variables for this day-ahead scheduling are fixed.
- In the subsequent planning periods starting repeatedly every three hours, the unit commitment and dispatch is rescheduled taking updated wind power and electricity demand forecasts into account. The adjustment of unit commitment and dispatch decisions is necessary, because the updated forecasts as well as the real wind energy generation and electricity demand usually differ from the forecast made in the previous day. To meet this requirement, the electricity generation of dispatchable power plants and storages must be increased or decreased compared to the planning of the previous day thereby considering inter-temporal operational restrictions. The forecast horizons of the individual planning periods always end with the second day, i.e. the optimisation period is reduced by three hours in each planning period. The values of the day-ahead scheduling are taken as starting points for the unit commitment and dispatch. The recourse decisions are determined as up- or down-regulation due to updated wind power and electricity demand forecasts.

If the beginning of the planning period reaches 12 o'clock again, the planning process starts again with a forecasting horizon of 36 hours and under consideration of the trade on the day-ahead spot market. In this way, eight planning periods for the modelling of one day and 2 920 planning periods for the modelling of one year are required. The finally realised operation of the single power plants and storages results from the combination of unit commitment decisions from the day-ahead planning period with a forecasting horizon of 36 hours and the successive planning periods with the shorter planning horizon.

With a deterministic modelling of wind power generation and electricity demand forecasts, only one occurrence of the forecast error is considered in the unit commitment and dispatch optimisation. Stochastic programming enables, in addition to a point forecast, the consideration of the possible distribution of the wind and load forecast error. The forecast error distribution is depicted by scenario trees with discrete error levels. The structure of the scenario trees has three stages. The first one covers the first three forecasting hours and describes deterministically the cost optimal system operation. In the second stage of the scenario tree, which also covers three hours, five scenarios covering a forecasting horizon of four to six hours ahead are taken into consideration. Each one of these five scenarios branches in the third stage into two further scenarios. Hence, ten discrete scenarios describe the error distribution of short-term forecasts. Each forecast scenario is described by a probability of occurrence. The applied structure of the scenario tree and the number of discrete scenarios are subject to a compromise between a fair approximation of the distribution density function of stochastic variables and the computational effort of the resulting optimisation problems.

## Appendix 7.B

### The impacts of the annual volatility of wind and solar generation

The electricity generation generated by some renewables, such as wind, solar and hydro, depend on the availability of the natural resource. Annual production might thus vary significantly from one year to another. This is particularly relevant for wind energy, for which the annual electricity production can decrease by up to 15% in comparison to an average year. This has an important impact on electricity systems relying significantly on generation from variable renewables. In order to assess the effects of a lower availability of wind and solar resources on the configuration of a least-cost electricity system operation, the annual electricity generation of wind and PV power plants is reduced by 15% for the scenarios with a renewable share of 80%.

Figure 7.1B compares the annual electricity generation for the scenarios with an 80% renewable share and with normal and low availability of electricity generation from wind and PV power plants. With the reduced availability of variable renewables, pump storage is used less, but curtailment of wind and PV power plants still amounts to approximately 4% of their annual electricity generation. In total, renewables show a share of 68% in the annual electricity demand. If present in the conventional generating portfolio, nuclear power plants can compensate for the decrease of the electricity generation from wind and PV power plants. In the scenario without nuclear, mainly gas-fired power plants are used to replace the shortfall from wind and PV power plants.

**Figure 7.1B: Annual electricity generation for scenarios with 80% renewables and varying annual availability of electricity generation from wind and PV power plants**

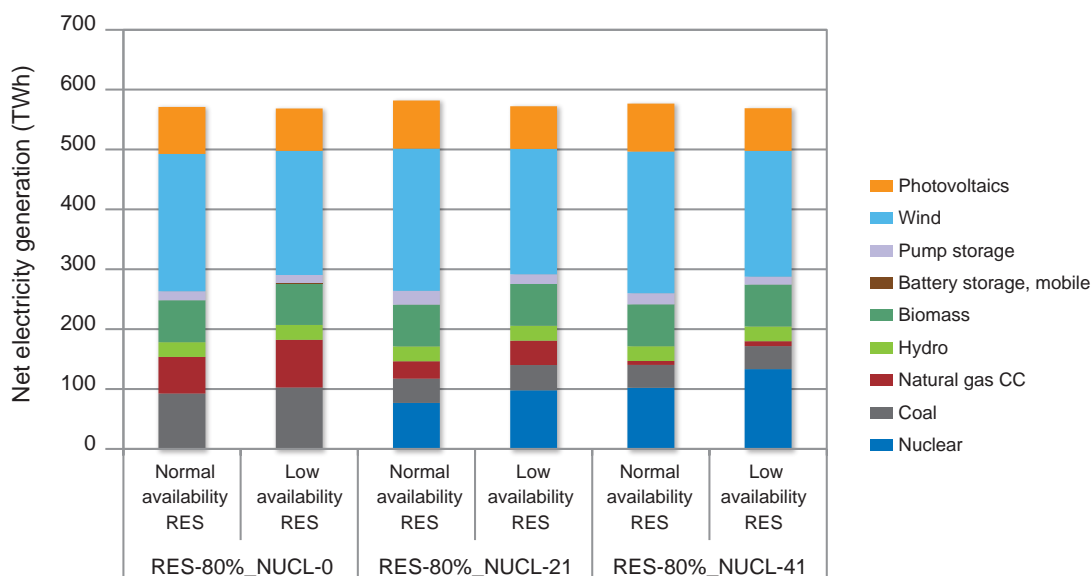
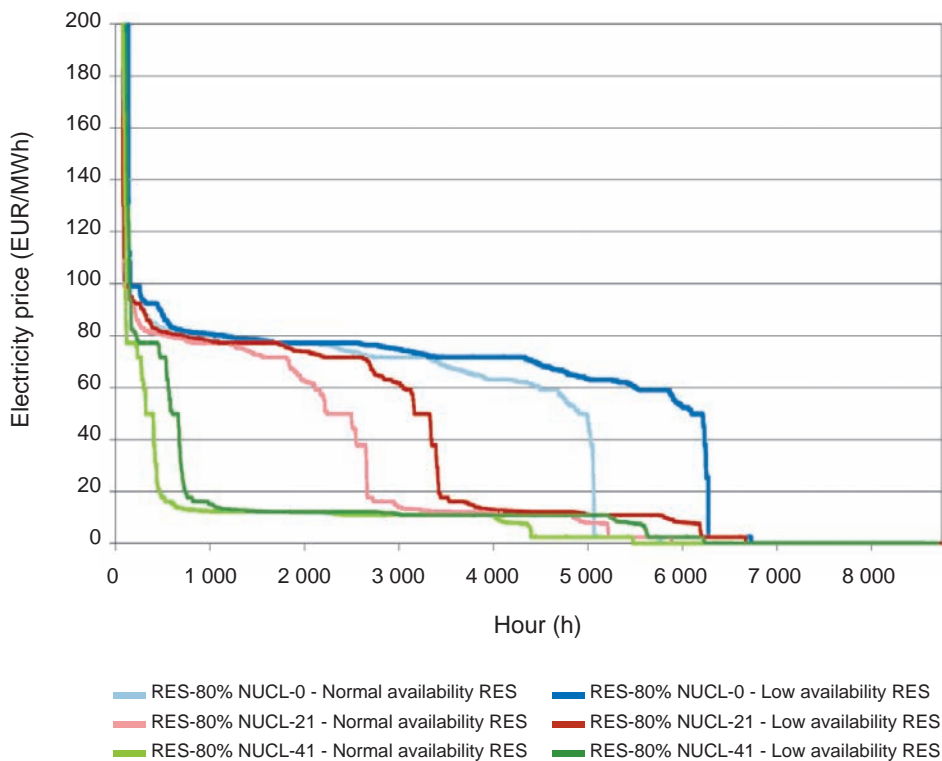

Figure 7.2B shows the impacts of the reduced availability of variable renewables on the electricity price. As expected, total electricity system costs are higher with lower availabilities of wind and PV power generation, since the electricity normally produced by low marginal cost technology must be substituted by more expensive technologies. The corresponding cost increase is mainly due to additional costs for fossil fuels and CO<sub>2</sub> emission certificates. Yet, the differences between the cases with average and reduced availability of wind and PV power generation are comparably low, since a considerable part of the lost renewable generation would have been curtailed. However, electricity systems featuring nuclear energy show a lesser increase in total production cost, since the electricity from renewables is mainly replaced by nuclear, which has much lower marginal cost than fossil fuelled technologies.

Finally, electricity prices tend to increase with a reduced availability of wind and PV power generation. However, the presence of nuclear power in the electricity system reduces the extent of this effect. In the scenario with doubled nuclear power, the price increase due to lower availability of renewables is significantly lower than in the scenarios with a capacity of 21 GW of nuclear power and without nuclear power.

**Figure 7.2B: Duration curves for wholesale electricity prices for scenarios with 80% renewables and varying annual availability of electricity generation from wind and PV power plants**



## References

- BDEW (2011), *Abschätzung des Ausbaubedarfs in deutschen Verteilnetzen auf Grund von Photovoltaik- und Windeinspeisungen bis 2020*, German Association for Energy and Water (BDEW), Bonn/Aachen, Germany.
- Dena (2010a), “Integration of Renewable Energy Sources in the German Power Supply System from 2015-2020”, Dena Grid Study II, Deutsche Energie-Agentur, November, Berlin, Germany.
- Dena (2010b), *Analyse der Notwendigkeit des Ausbaus von Pumpspeicherwerken und anderen Stromspeichern zur Integration der erneuerbaren Energien*, Berlin, Germany.
- EC (2011), *European Energy Roadmap 2050*, European Commission, Brussels, Belgium.
- EEX (2012), *European Energy Exchange: Transparency in Energy Markets*, Leipzig, Germany, [www.transparency.eex.com/de/](http://www.transparency.eex.com/de/).
- ENTSO-E (2012), *Consumption Data*, European Network of Transmission System Operators for Electricity, Brussels, Belgium, [www.entsoe.eu/resources/data-portal/consumption/](http://www.entsoe.eu/resources/data-portal/consumption/).
- Hartmann, N., L. Eltrop, J. Salzer, N. Bauer, S. Schwarz and M. Schmidt (forthcoming), *Stromspeicherpotenziale für Deutschland*, Study for the Energy Research Center, Stuttgart.
- Hundt, M., R. Barth and N. Sun (2009), “Compatibility of Renewable Energies and Nuclear Power in the Generation Portfolio”, Study for the E.ON Energie AG, Munich, Germany. Available at [www.ier.uni-stuttgart.de/publikationen/pb\\_pdf/Hundt\\_EEKE\\_Summary.pdf](http://www.ier.uni-stuttgart.de/publikationen/pb_pdf/Hundt_EEKE_Summary.pdf).
- IEA (2010), *World Energy Outlook 2010*, International Energy Agency, OECD, Paris, France.
- TransnetBW GmbH (2012), *50Hertz Transmission GmbH, Amprion GmbH, Tennet TSO GmbH, Netzentwicklungsplan Strom 2012. Entwurf der Übertragungsnetzbetreiber*, Berlin, Dortmund, Bayreuth, Stuttgart, Germany.
- Voß, A., M. Hundt, R. Barth and N. Sun (2011), “Kernkraft und erneuerbare Energien – Technische Flexibilität zum Ausgleich zufälliger Einspeisung”, VGB PowerTech, 1-2, S. 54-57, Essen, Germany.



## Chapter 8

# Lessons learnt and policy recommendations

### 8.1 System effects: the need for policy action

Significant amounts of electricity produced by variable renewables are already being absorbed by the decarbonising electricity sectors of OECD countries, and much larger amounts are expected to arrive in the future. In the process, they are generating a number of hitherto unaccounted system effects that are composed of the increased costs for transport and distribution grids, short-term balancing and long-term adequacy to guarantee the security of electricity supplies at all times. As important as these technical externalities are the pecuniary externalities. The advent of electricity from variable renewables is thus massively affecting the economics of dispatchable power generation technologies, in particular those of nuclear power.

This concerns both the profitability of existing nuclear power plants in the short run and the outlook for nuclear new build in the long run. In the short run, while the current structure of the power generation mix remains in place, all dispatchable technologies, nuclear, coal and gas will suffer due to lower average electricity prices and reduced load factors. Due to their relatively low variable costs, however, existing nuclear power plants will do relatively better than gas and coal plants, which are already suffering substantially.

In the long run, however, high fixed cost technologies such as nuclear will suffer disproportionately from the increased difficulties to finance investments in volatile low-price environments. Final outcomes will depend on the amount of variable renewables being introduced, local circumstances and, of course, the level of carbon prices. One needs to remember that while nuclear power has some system costs of its own, it remains the only major dispatchable low-carbon source of electricity that is not limited in supply. Carbon prices will thus be an increasingly important tool to differentiate between low-carbon and high-carbon dispatchable technologies. Whatever, the specific constellation, however, nuclear energy will need to become more flexible as it will be increasingly valued not as a provider of baseload electricity but as a provider of low-carbon back-up capacity.

Variable renewables are in the process of creating, and to some extent have already created, a market environment in which dispatchable technologies, and this holds for nuclear as much as for coal or gas, are no longer able to finance themselves through revenues in “energy-only” electricity wholesale markets. This has serious implications for the security of electricity supplies. It is only due to the weakened demand for electricity in the current low-growth environment of OECD economies and the considerable excess capacity constructed during more favourable periods in the past that more serious stresses have so far been avoided.

Due to zero short-run marginal costs and their isolation from market forces through long-term subsidy commitments, already relatively modest amounts of variable renewables in electricity generation, say in the order of 10 to 20% and far below the long-term objectives of most OECD countries, can have a decisive impact on deregulated electricity markets. Already today, the technical and pecuniary system effects of variable renewables are putting considerable stress on the long-term adequacy of the electricity systems of OECD countries. The increasing variability of the demand for dispatchable production, the difference between variable renewable production and total demand, increases risk and makes the financing of dispatchable capacity even more challenging (see Chapter 7 and the study by IER Stuttgart).

The clear implication is that dispatchable technologies, including nuclear, will require that a portion of their revenues be derived from other sources if they are to stay in the market and provide the necessary back-up services. There currently exist three major perspectives in which such additional revenue generation can be envisaged:

- Capacity payments or markets with capacity obligations, in which variable producers need to acquire the adequacy services from dispatchable providers, which would thus earn additional revenue.
- Long-term fixed-price contracts subscribed by governments for guaranteed portions of the output of dispatchable plants whether in the form of contracts for differences or feed-in tariffs.
- The gradual phase-out of subsidies to variable renewables and the discontinuation of grid priority, and a “shallow” allocation of additional grid costs; this would slow down the latter’s deployment, which is currently bought at considerable economic cost, but would also force them to internalise at least partially grid costs and balancing costs.

Governments and regulators in OECD countries will need to start swiftly the necessary processes of education, consultation and consistent policy formulation that will allow for such additional mechanisms. This is not an easy task. Given that all such mechanisms will raise electricity prices and could also be seen as support for technologies such as nuclear, coal or gas, such necessary reforms will be unpopular unless their underlying rationale, the protection of electricity supply security, is convincingly explained and communicated. The alternative, repeated challenges to and occasional breakdowns of electricity supply, is far worse.

## 8.2 On this study

The present study has attempted a first overview of the multifaceted issue of system costs by providing a conceptual clarification of the issue, a survey of the system effects of nuclear energy, an assessment of the ability of nuclear power to provide flexible back-up in the presence of intermittency, an empirical evaluation of the system costs of different technologies, a framework for the necessary regulatory responses, an outline of possible future answers to the issue of system costs as well as an in-depth country study.

By their very nature, system costs, which are part of network externalities, are a complex subject. The study has thus steered a carefully calibrated path between conceptual discussions, the technical assessment of nuclear energy, the empirical estimates of system costs and policy recommendations. Quite naturally, the empirical estimates of system costs provided in this study are of great interest. However, they need to be treated with a certain caution since the methodological protocols to assess system costs are currently still under development as part of a wide-ranging global effort involving international organisations, industrial research centres and universities. The OECD/NEA system cost study is very much part of this global effort and situates itself at the forefront of current discussions.

Despite the uncertainties, the methodological debate under way and the definitional problems, there is no doubt about the general result of the study. System costs, in particular the system costs of intermittent renewables, such as offshore wind, are large. Depending on country and technology, system costs make up between 11% and 34% (with a median of 20%) of the total national generation costs per MWh of electricity once intermittent renewables constitute a sizeable share of electricity production.<sup>1</sup>

1. The study works with benchmark levels of 10% and 30% of electricity produced by intermittent renewables. The quoted figures refer to 30% of electricity produced by intermittent renewables. At 10% of penetration by intermittent renewables, system costs constitute between 2% and 11% (with a median 5%) of total system costs. The differences between countries are due to differences in load factors and the cost of back-up capacity. The system costs of the three key technologies increase from onshore wind to offshore wind and solar PV, but the differences between technologies are ultimately of a lesser magnitude than the differences between countries.



This amounts to billions of dollars that are added to the annual costs of national energy systems. These system-level costs come over and above the higher plant-level costs of renewables. Including the latter, based on the figures contained in the 2010 IEA/NEA study on the *Projected Costs of Generating Electricity* as well as more recent figures for solar power, increases total generating costs by up to 30% for onshore wind, up to 50% for offshore wind and up to 200% for solar energy.

It is important to understand that the estimated amounts constitute real financial costs. These are not estimates of externalities that affect welfare beyond monetary incomes in a non-specific, long-run manner but true costs that arise in the form of increased annual outlays for running the electricity system. These will need to be paid by somebody, most likely by taxpayers and electricity consumers in the form of higher taxes and higher electricity prices.

In order to correctly understand the system costs figures, nevertheless, a number of conceptual clarifications need to be considered. The first of these concerns the distinction between a short-term *ex post* and a long-term *ex ante* approach. As explained in Chapter 1, the *ex post* case concerns the costs of introducing intermittent renewables into a system, which currently already possesses adequate conventional capacity and thus does not require additional investments for ensuring capacity. One might think of France or the United States, which currently both possess adequate conventional capacity. The *ex ante* case instead requires investment in new generating capacity, since existing capacity will need to be retired or new demand will need to be covered. One might think of Germany, which is phasing out almost 17 GW of nuclear power by 2022, or the United Kingdom, which will need to retire 19 GW of coal and nuclear capacity that reached the end of its technical lifetime by 2020. Both countries will need to install a mix of new generating capacity that corresponds to the amount and the performance of the old, dispatchable, capacity. If not otherwise indicated, this study works with the long-term *ex ante* case.<sup>2</sup>

Working with the *ex ante* case implies that the cost of dispatchable back-up capacity needs to be included. Back-up capacity can be provided by different dispatchable technologies such as nuclear, coal, gas or hydro. Given that these technologies have different cost profiles, in particular different fixed costs, the costs for flexible back-up depends on the technology chosen. This study calculated a least-cost mix for the provision of back-up dispatchable power based on the annual load curve, capacity credits and country-specific technology costs.

Depending on the structure of the existing system, the load factors of different renewable technologies, the seasonal and daily load curve, fuel costs as well as needs for additional investments in the grid infrastructure, the introduction of significant amounts of intermittent renewables will cause different costs in different countries. System costs are not only costs that apply at the system level, they are also dependent on the particular system in which they accrue. Solar PV in the south-western United States, where due to air-conditioning the demand peak is at noon time in summer, does not have the same system costs as the identical technology in France, where the demand peak is in the evening in winter due to electric heating. Of course, a study at the OECD level cannot take all these subtleties into account but can provide only a first approximation. Nevertheless, even at that level, the figures show convincingly that system costs are heavily context-dependent.

The study does not systematically quantify the costs of the long-term de-optimisation of current electricity systems country-by-country. This requires considerable resources and such studies would best be done at the level of the single country according to a common methodology. It does, however, provide numerical examples of this process, as the arrival of intermittent renewables has an important impact on the absolute and relative profitability of existing dispatchable plants both in the short run and in the long run. This impact is referred to as the “compression effect”, i.e., a reduction in load factors and average prices for existing plants as renewables with low marginal costs will push into the market.

2. While the long-term *ex ante* figures for system costs as defined in the study (grid-level externalities) are higher than the short-term *ex post* figures due to the inclusion of capital costs for dispatchable capacity, this does not mean that the total costs at the system-level are lower. This is due to the fact that in the short-term *ex post* case, the introduction of renewable capacity into a system that does not require any additional capacity constitutes an allocation of resources that is unambiguously wasteful, as savings in variable costs only very partially substitute for unneeded outlays in capital costs. In the long-term *ex ante* case, at least the capacity credit of renewables, even if small, is applicable. The difference between the two cases is that in the long-term *ex ante* approach, the capital costs for dispatchable back-up capacity are considered as being part of grid-level system costs, whereas in the short-term *ex post* approach, the latter are considered as sunk costs.

As mentioned above, in the short run, with a generation portfolio established in the absence of renewables, nuclear energy with fixed costs partly or totally amortised will be able to cope relatively better due to its relatively lower variable costs. Gas turbines with their high variable costs instead will increasingly fall out of the merit order of production. In the long run, however, when new investments will need to be considered, the optimal share of technologies with high fixed costs that require high load factors for amortisation, such as nuclear energy, will be reduced by the compression effect as well as by the increased variability of demand and prices. The share of gas instead whose lower capital costs allow investments with relatively lower load factors and greater risk will tend to increase.

Two points need to be considered here. First, an increased share of gas at the expense of nuclear energy will increase carbon emissions. The study shows that in the long run, in France, for instance carbon emissions might increase by up to 26% in a 30% wind scenario and by up to 125% in a 30% solar scenario.<sup>3</sup> Countervailing measures such as a carbon tax might ensure equilibria much closer to the old optimum, with changes essentially taking place between coal and gas. Second, the transition between the short run and the long run can be several decades, the time for the capital stock to roll over. Given that the optimal generation mix is a moving target as a function of costs, electricity prices and the share of intermittent renewables, it is very difficult to predict the final electricity mix.

### 8.3 Lessons learnt

Given the clarifications above and given the remaining conceptual and empirical challenges, there are nevertheless a number of straightforward and robust lessons than can be drawn from this study. The first is simple but powerful: system effects at the grid-level are large and require attention from decision-makers in the energy sector in general and in the nuclear industry in particular. The current socialisation of system effects is equivalent to adding substantial amounts of hidden subsidies to already considerable explicit subsidies.

Second, due to its particular cost structure but also due to the fact that it is the only dispatchable source of low carbon other than hydropower, the impacts of the introduction of significant amounts of intermittent renewables are very high for nuclear energy. The early choice of clear positions in a debate whose contours are still evolving, such as the demand for the publication and internalisation of system costs as well as for a carbon tax to counter the long-term outfall from the compression effect might be vital for the success or the failure of nuclear industry in the decarbonising electricity systems of OECD countries.

Third, the grid-level system effects of nuclear energy are comparatively small and the technical abilities of nuclear power to engage in load following to back-up variable renewables to ensure the demand-supply balance are good. While extreme variations of residual demand will always be satisfied by gas- or even oil-fired open cycle gas turbines, nuclear power plants are on a par with coal-fired and close to combined cycle gas turbines in managing variations in baseload and mid-load. While load following with nuclear power plants is not universally adopted in OECD countries, there exists significant experience in France and in Germany, both countries with widely recognised regulatory systems and very good safety records.

Fourth, load following implies its own economic costs, especially if fixed costs still need to be repaid. These costs consist less of the slightly increased O&M costs and the potential increase in the wear and tear of materials (for which there is little evidence for the time being), but in the reduced load factors of nuclear power plants. This compression effect is, in the long run, particularly awkward for high-fixed costs technologies such as nuclear energy, which rely on a steady flow of revenue to repay the initial investment costs. In the ensuing competition between dispatchable back-up providers, final outcomes will be determined to a significant extent by carbon prices.

3. The large difference between the two scenarios is due to the fact that solar production is concentrated during daytime hours, which means higher overall variability of the residual load and a more carbon-intensive back-up mix. This holds in France where solar essentially has a zero capacity credit.

Fifth, the very size of both technical and pecuniary system costs implies that they can no longer be borne in a diffuse and unacknowledged manner by operators of dispatchable technologies as an unspecific system service. Currently, dispatchable technologies are expected to provide the backup for intermittent renewables to cover demand when the latter are unavailable. This service is costly, but currently not remunerated. Economically speaking, dispatchable technologies are expected to provide the not remunerated positive externality of long-term flexible capacity for back-up. The correspondent investment needs and costs are only gradually becoming apparent. However, once the need for such back-up has become obvious by means of a physical breakdown of the system, it will take several years to rebuild the conditions that are today taken for granted. System costs require fair and transparent allocation mechanisms as soon as possible so that corresponding actions can be taken in time. Proper allocation notwithstanding, system costs will be integrated in the electricity price and ultimately paid for by electricity customers.

Sixth, new regulatory frameworks are needed to cope with system effects and, in particular, long-term capacity provision. Capacity payments are already being used in several electricity markets of OECD countries and a number of others are considering them. An alternative would be markets with capacity obligations, which will force operators with variable generation profiles to acquire flexible back-up capacity, which in turn will remunerate providers of such capacity. This will also enable other flexibility providers to compete with dispatchable back-up on marginal costs. Storage, improved interconnections and demand-side management (load reduction) all have their roles to play in certain contexts and circumstances. “Smart grids” capable of providing appropriate signals for load balancing to large numbers of producers and consumers will also accelerate a structural transformation of electricity markets. For the generalised provision of both balancing services and long-term adequacy of capacity, however, physical back-up by thermal power producers or hydropower is for the time being still the most economical option.

Seventh, system costs increase over-proportionally with the share of intermittent renewables. There is some evidence pointing towards an intrinsic upper bound concerning the sustainable deployment of intermittent renewables in integrated electricity systems. A recent study commissioned by the European Commission arrives at the following conclusions:

“The policy implication of this analysis is that there are clear limits to the deployment of intermittent generation technologies in the EU-27. Furthermore, a corresponding upper threshold is estimated to be around 40% for the share of intermittent generation capacity in both a 2030 and 2050 perspective (with 5% uncertainty). Beyond this share, costly additional preventive measures will have to be taken in order to guarantee power system stability.”<sup>4</sup>

This is of particular relevance with respect to policy initiatives such as the objective of the European Union to decarbonise the European electricity sector by 2050 with up to two thirds of electricity production due to wind and solar. While these objectives do not yet have the force of law, they provide the basis for current discussions about the contours of the European electricity sector.<sup>5</sup> Attaining the decarbonisation of the electricity sector with a majority of production stemming from intermittent renewables seems to pose very considerable technical and commercial challenges at the current state of technology as 100% of dispatchable back-up would frequently need to be mobilised in time frames of less than 24 hours. This puts great stress on production equipment and transport infrastructures referred to as “ramp costs”. However, the precise magnitude of such ramp costs is still a matter of expert debate and precise metrics applicable, in particular, to frequent and massive system-level rather than plant-level ramping still need to be developed.

Ambitions greenhouse gas emission reductions would be attainable in a far more realistic fashion if electricity generation from intermittent renewables was accompanied by an increase of nuclear power production that served as a dispatchable low-carbon baseload producer thus reducing the need for system-wide load shifts.

4. Wietze, L., J. van der Laan, K. Rademaekers and F. Nieuwenhout (2011), *Assessment of the Required Share for a Stable EU Electricity Supply until 2050*, European Commission, Brussels, Belgium.

5. See the *Energy Roadmap 2050* at [http://ec.europa.eu/energy/energy2020/roadmap/index\\_en.htm](http://ec.europa.eu/energy/energy2020/roadmap/index_en.htm).

## 8.4 Policy recommendations

The integration of large amounts of intermittent renewables to reduce greenhouse gas emissions is a complex issue that profoundly challenges the current structure, financing and operational mode of the electricity systems in OECD countries. The present study, overseen by the Working Party on Nuclear Energy Economics (WPNE) of the OECD Nuclear Energy Agency, provides a first overview of the effects generated by the interaction of nuclear energy and intermittent renewables in such decarbonising electricity systems.

A broad topic such as the system costs of intermittent power generation technologies in the interaction with nuclear energy necessarily yields a great number of policy proposals for improving matters, not all of them compatible with each other. The validity of any individual proposals also remains contingent on a number of parameters that are country-dependent or have not yet stabilised since this is a new topic with moving boundaries. The “turning point” of the path towards decarbonised electricity systems has only begun and the final outcome is still highly uncertain. Nevertheless, the fundamental questions of this study “what are the system costs of different power generation technologies?” and “what is the role that nuclear energy can play to alleviate them in the context of reducing the greenhouse gas emissions from power generation?” are here to stay.

While future studies will undoubtedly refine the results of this study, in particular with respect to the empirical estimates, current research already allows the identification of the broad contours of a number of the key issues. On the basis of a careful literature review, the input and comment from member countries, the exchange with experts from all boards as well as the analytical work produced by the Secretariat as well as individual WPNE members, this study has thus identified four main policy conclusions. OECD countries are recommended to give attention to them with a view to minimising, or, in fact, just controlling the overall costs of their present and future power generation systems.

### **Recommendation 1: Ensure the transparency of power generation costs at the system level**

While all power generation technologies produce some system costs, those of intermittent renewables are of an order of magnitude larger than those of other technologies. Contrary to classical external effects (environment, security of supply), which always contain a uncodified, subjective or political dimension, system costs at the grid level constitute real monetary costs that need to be paid for by somebody out of current income, most frequently electricity consumers. Without adequate initiatives to account for these costs, they constitute hidden subsidies of a considerable magnitude. Some of these costs are already apparent (such as the costs for short-term balancing), others are in the process of being recognised (such as the costs for offshore grid connection and internal grid enforcement), yet others will manifest themselves increasingly over the coming years (such as the costs for ensuring investments in long-term adequacy and the de-optimisation of electricity systems).

*When making policy decisions affecting their electricity markets, OECD countries need to consider the full system costs of different technologies. Failure to do so will rebound in terms of unanticipated cost increases in overall power supply for many years to come.*

### **Recommendation 2: Prepare regulatory frameworks to minimise system costs and favour their internalisation**

Intermittency requires the costly provision of flexible back-up. Regulatory systems must allow the different providers of flexibility to compete in an integrated market framework, while ensuring that the respective costs are allocated in a fair and transparent manner between the generating technologies causing the relevant system costs, other electricity producers, taxpayers and consumers. This includes the appropriate remuneration for capacity provision as well as attention to other important side-effects. Dispatchable back-up from fossil fuel-based power generation technologies such as natural gas may seem attractive due to their relatively lower fixed costs, which facilitates coping with reduced load factors. However, this means that eventually dispatchable technologies with high fixed costs such as nuclear will be displaced by technologies with lower fixed costs such as gas. Ultimately, this implies that introducing intermittent renewables into systems with significant shares of nuclear power can increase

rather than decrease overall carbon emissions. Back-up provided by dispatchable renewable technologies such as biomass raise different issues relating to costs, sustainable forestry and local air quality. Alternative sources of flexibility provision, such as storage, increased grid interconnection and demand-side management also have roles to play but are currently hindered by factors such as costs (storage, demand-side management), intrinsic physical limits (interconnections) or technology. Together with nuclear energy all options need to be brought together in new integrated regulatory frameworks.

OECD countries with major shares of intermittent renewables need to plan and implement coherent strategies for the long-term adequacy of their energy systems. Four points have particular importance for rendering future electricity market frameworks sustainable:

- The decrease in revenues for the operators of dispatchable capacity due to the compression effect needs to be recognised and adequately compensated through capacity payments or markets with capacity obligations.
- To internalise the system costs for balancing and adequacy effectively, one option may be to feed stable hourly bands of electricity into the grid rather than random amounts of intermittent electricity. If the introduction of variable renewables remains the overriding policy objective, additional non-proportional compensation can be offered.
- While costs for grid reinforcement and interconnection are difficult to allocate to any one technology, the costs for grid connection should be allocated as far as possible to the respective operators.
- The implications for carbon emissions of different strategies for back-up provision need to be closely monitored and should be internalised through a robust carbon tax.

### **Recommendation 3: Recognise the current and future role of dispatchable low-carbon technologies including nuclear energy**

Together with a number of dispatchable renewable energy sources such as biomass or geothermal power, whose current contribution is still limited, nuclear power can provide large amounts of dispatchable low-carbon electricity given that hydropower resources in OECD countries are largely exhausted. With the exception of countries with large hydropower resources that already exist such as Austria, Canada or Norway, any reduction of carbon emissions of the electricity systems of OECD countries requiring more than 30-40% of low-carbon electricity is difficult to envisage in an affordable manner at the current stage of technology. In addition, due to its good load following ability of about 3% of capacity per minute, nuclear energy is well suited to provide short- to medium-term load balancing services as well as long-term back-up for low-carbon power. Nevertheless, such services to the electricity system come at a price. The reduction of load factors due to the compression effect reduces the profitability of all dispatchable technologies. Nuclear power, however, is particularly affected due to its comparatively high fixed costs. As a rule of thumb and within the range of usually observed load factors, a 10% reduction of the load factor will increase the unit costs of nuclear power by an equivalent amount. While capacity markets can go some way to cover this loss, nuclear energy also requires efforts to bring down fixed costs and further research on technically safe and economically sustainable load following.

*The value of dispatchable low-carbon technologies in complementing the introduction of variable renewables should be more effectively recognised. Nuclear energy, as a low-carbon provider of flexible back-up capacity in systems with significant shares of intermittent renewables, plays an important role in meeting policy goals and should be recognised. A combination of capacity markets, long-term supply contracts and carbon taxes would provide a market-based framework to ensure that nuclear energy and other dispatchable low-carbon technologies remain economically sustainable.*

### **Recommendation 4: Flexibility resources for future low-carbon systems must be developed**

Reducing greenhouse gas emissions, decreasing fuel imports and increasing the security of energy supplies has led to the development of large amounts of variable renewable energy technologies such as wind and solar PV, alongside nuclear energy in those OECD countries that have decided to benefit from them. This study has focused on the system costs of these technologies, in particular those of variable renewables. It has also established that these costs are highly country-dependent. In particular, they are a function of a country's flexibility resources – dispatchable back-up capacity, storage, flexibility of

demand and interconnections to neighbouring countries. In the light of the shared objective of a low-carbon electricity mix, which at the current state of technology will imply high shares of both nuclear energy and variable renewables, the development of such flexibility resources is highly recommended. This will require proper regulatory frameworks such as markets for flexibility services, appropriate incentives as well as commensurate efforts in research and development in all domains: increasing the load following abilities of dispatchable low-carbon back-up including nuclear, expanding storage, rendering demand more responsive and increasing international interconnections. At all times, such efforts must be imbedded in a common vision of the evolution of the electricity system as a whole.

*At the current stage of technological development, low-carbon electricity systems will inevitably be based on high shares of variable renewables and nuclear energy. Hence it is recommended that flexibility resources should be developed based on a system approach where full costs and interdependencies are recognised. This will require increasing the load-following abilities of dispatchable low-carbon back-up including nuclear, expanding storage, rendering demand more responsive and increasing international interconnections.*

## **Annex 1**

# **Members of the Working Party on Nuclear Energy Economics (WPNE)**

### **BELGIUM**

Gilbert CORNELISSEN	SA Synatom
Chantal CORTVRIENDT	SPF économie, classe moyenne et énergie
Dirk VAN HERTEM	K.U. Leuven Energy Institute (ESAT)

### **CZECH REPUBLIC**

Lubor ŽEŽULA	Nuclear Research Institute Řež plc
--------------	------------------------------------

### **FRANCE**

Philippe LEBRETON	EDF-CIST
Frédéric LEGEE	Commissariat à l'énergie atomique et aux énergies alternatives (CEA Saclay)
François PERFEZOU	Ministère de l'Écologie, de l'Énergie, du Développement

### **GERMANY**

Johannes KERNER	Federal Ministry of Economics and Technology
Hans-Christoph PAPE	Federal Ministry of Economics and Technology
Alfred VOSS (Chairman)	Universität Stuttgart, Institut für Energiewirtschaft und rationelle Energieanwendung

### **HUNGARY**

Károly GERSE	Magyar Villamos Muvek Zrt. (MVM)
György WOLF	Paks NPP

### **ITALY**

Sara BOARIN	Politecnico di Milano
Marco CIOTTI	ENEA
Marco RICOTTI	Politecnico di Milano
Fortunato VETTRAINO ( <i>retired</i> )	Ente per le Nuove Tecnologie, l'Energia e l'Ambiente (ENEA)

### **JAPAN**

Kazuaki MATSUI	The Institute of Applied Energy (IAE)
Koji NAGANO	Central Research Institute of Electric Power Industry (CRIEPI)

**KOREA (REPUBLIC OF)**

Hun BAEK	Korea Hydro & Nuclear Power Co., Ltd (KHNP)
Kun Jai LEE	Korea Advanced Institute of Science and Technology (KAIST)
Mankin LEE	Korea Atomic Energy Research Institute (KAERI)
Jin-ho OH	Korea Hydro & Nuclear Power Co., Ltd (KHNP)
Kee Hwan MOON	Korea Atomic Energy Research Institute (KAERI)

**NETHERLANDS**

Elske van EFFERINK	Energy & Sustainability
Gert van UITERT ( <i>retired</i> )	Ministry of Economic Affairs

**POLAND**

Roman RUSZCZYNSKI	PGE Energia Jadrowa S.A.
Olgierd SKONIECZNY	PGE Energia Jadrowa S.A.
Andrzej STRUPCZEWSKI	Institute of Atomic Energy POLATOM

**SPAIN**

Antonio GONZÁLEZ JIMÉNEZ	Spanish Nuclear Industry Forum
--------------------------	--------------------------------

**SWITZERLAND**

Michel DELANNAY	Kernkraftwerk Gösgen-Däniken AG
Roger J. LUNDMARK	Swissnuclear

**TURKEY**

Ali LOGOGLU	Electricity Generation Company (EUAS) Ministry of Energy and Natural Sources
-------------	--

**UNITED STATES**

Matthew P. CROZAT (Chairman)	Office of Nuclear Energy, US Department of Energy
------------------------------	---

**European Commission (EC)**

Christian KIRCHSTEIGER	DG TREN H2
------------------------	------------

**International Atomic Energy Agency (IAEA)**

Nadira BARKATULLAH	Department of Nuclear Energy
--------------------	------------------------------

**International Energy Agency (IEA)**

Laszlo VARRO	IEA/EMS/GCP
--------------	-------------

**OECD Nuclear Energy Agency (NEA)**

Ron CAMERON	Head, Nuclear Development Division (NDD)
Jan Horst KEPPLER	Principal Economist, NDD
Marco COMETTO	Nuclear Energy Analyst, NDD



## Additional experts attending the international WPNE workshops and OECD/IEA/NEA roundtable

Experts attending the International WPNE Workshop on “The System Effects of Nuclear Power – The Contribution of Nuclear Power in a Low-Carbon Electricity Future”, held on 24 May 2011 at NEA Headquarters in Issy les Moulineaux; the International WPNE Workshop on “Nuclear Power and the System Effects of Electricity Generation”, held on 9 November 2011 at the OECD Conference Centre in Paris; and the OECD IEA/NEA Round Table on “The Integration of Intermittent Renewables in Decarbonising Electricity Systems”, held on 16 May 2012 at the OECD Conference Centre in Paris.

### **BELGIUM**

Erik DELARUE K.U. Leuven Energy Institute (ESAT)

### **CZECH REPUBLIC**

Martin RUSKA Nuclear Research Institute Řež plc

### **FINLAND**

Hannele HOLTINEN VTT Technical Research Centre of Finland  
Jussi JYRINSALO Fingrid Oyj

### **FRANCE**

Raphael BERGER AREVA

### **GERMANY**

Rüdiger BARTH Universität Stuttgart  
Christoph RIECHMANN Frontier Economics Limited

### **KOREA (REPUBLIC OF)**

Ji-Hee NAM Korea Atomic Energy Research Institute (KAERI)

### **UNITED STATES**

Jean-Pierre SURSOCK Nuclear Power Sector, Electric Power Research Institute (EPRI)

### **OECD Environment Directorate**

Antony COX Head of Division, ENV/EEI  
Nick JOHNSTONE Principal Administrator, ENV/EEI  
Ivan HASCIC Economist, Policy Analyst, ENV/EEI  
David BENATIA Intern, ENV/EEI

### **OECD Trade and Agriculture Directorate**

Ron STEENBLIK Senior Trade Policy Analyst, TAD/EP  
Heymi BAHAR Trade Policy Analyst, TAD/EP  
Jehan SAUVAGE Trade Policy Analyst, TAD/EP

**International Energy Agency (IEA)**

Paolo FRANKL	Head of Division, IEA/EMS/RED
Manuel BARITAUD	Senior Electricity Analyst, IEA/EMS/GCP
Hugo CHANDLER	Energy Analyst, IEA/EMS/RED
Simon MUELLER	Energy Analyst, IEA/EMS/RED
Dennis VOLK	Energy Analyst, IEA/EMS/GCP
Carlos GASCO	IEA/EMS/RED
Shinichiro KADONO	IEA/EMS/GCP
Katrin SCHABER	IEA/OCE

**OECD Nuclear Energy Agency (NEA)**

Alexey LOKHOV	Nuclear Energy Analyst, NDD
Abdulhaki KORBAYRAM	Nuclear Energy Analyst, NDD
Eduard BLANQUET I ARAGO	Intern, NDD

## **Annex 2**

# **Acronyms**

ABWR	Advanced boiling water reactor
AC	Alternating current
ALWR	Advanced light water reactor
BWR	Boiling water reactor
CAES	Compressed air energy storage
CCGT	Combined cycle gas turbine
CCS	Carbon capture and storage
CHP	Combined heat and power
CSP	Concentrated solar power
DC	Direct current
DR	Demand response
DSM	Demand-side management
EC	European Commission
EEX	European Energy Exchange Market
efpd	Equivalent full power days
EMR	Electricity market reform (United Kingdom)
ENTSO-E	European Network of Transmission System Operators for Electricity
EPEX SPOT	European Power Exchange
EPR	European pressurised reactor
EPRI	Electric Power Research Institute (United States)
ERCOT	Electric Reliability Council of Texas (United States)
ESBWR	Economic simplified boiling water reactor
E2M2s	European Electricity Market Model
FIPs	Feed-in premiums
FITs	Feed-in tariffs
GHG	Greenhouse gas
HVDC	High voltage direct current
IAEA	International Atomic Energy Agency
ICT	Information and communication technologies
IEA	International Energy Agency
IER	Institute for Energy Economics and the Rational Use of Energy, University of Stuttgart
JMM	Joint Market Model
LCOE	Levelised costs of electricity
LMP	Locational marginal price
LOLP	Loss of load probability
LOOP	Loss of offsite power

LWR	Light water reactor
O&M	Operations and maintenance
NDC	Committee for Technical and Economic Studies on Nuclear Energy Development and the Fuel Cycle
NEA	Nuclear Energy Agency
NEEDS	New Energy Externalities Development for Sustainability (EC)
NPP	Nuclear power plant
NRC	Nuclear Regulatory Commission (United States)
OCGT	Open cycle gas turbines
OECD	Organisation for Economic Co-operation and Development
PCI	Pellet-cladding interaction
PRIS	Power Reactors Information System database (IAEA)
PV	Photovoltaic
PWR	Pressurised water reactor
SCC	Stress corrosion cracking
SMR	Small modular reactor
SSDI	Simplified Supply and Demand Index
SSE	Safe shutdown earthquake
TGC	Tradable green certificate
TSOs	Transmission system operators
UCTE	Union for the Coordination of the Transmission of Electricity
VOLL	Value of lost load
VPP	Virtual power plants
VVER	Vodo-Vodianoy Energetichesky Reactor (water-cooled, water-moderated power reactor)
WPNE	Working Party on Nuclear Energy Economics

### Units

billion	1 000 million
G	giga = $10^9$
k	kilo = $10^3$
M	mega = $10^6$
m	milli = $10^{-3}$
T	tera = $10^{12}$
Bq/l	becquerel per litre
GW	gigawatt
GWe	gigawatt electric
GWth	gigawatt thermal
GWd/t	gigawatt-days per tonne
ha	hectare (10 thousand m <sup>2</sup> )
Hz	hertz
kV	kilo Volt
kWh	kilowatt-hour
mHz	millihertz
mm	millimetre
Mtoe	million tonnes of oil equivalent

---

MW	megawatt
MWh	megawatt hour
MW(th)	megawatt thermal
ppb	parts per billion
SWU	separative work unit
TWh	terawatt hour
V	voltage
/y	per year

## NEA PUBLICATIONS AND INFORMATION

### Printed material

The NEA produces a large selection of printed material, part of which is on sale, and part of which is distributed free of charge. The full catalogue of publications is available online at [www.oecd-nea.org/pub](http://www.oecd-nea.org/pub).

### Internet and electronic products

In addition to basic information on the Agency and its work programme, the **NEA website** offers free downloads of hundreds of technical and policy-oriented reports.

An **NEA monthly electronic bulletin** is distributed free of charge to subscribers, providing updates of new results, events and publications. Sign up at [www.oecd-nea.org/bulletin](http://www.oecd-nea.org/bulletin).

Visit us on **Facebook** at [www.facebook.com/OECDNuclearEnergyAgency](http://www.facebook.com/OECDNuclearEnergyAgency) or follow us on **Twitter** @OECD\_NEA.



# Nuclear Energy and Renewables: System Effects in Low-carbon Electricity Systems

This report addresses the increasingly important interactions of variable renewables and dispatchable energy technologies, such as nuclear power, in terms of their effects on electricity systems. These effects add costs to the production of electricity, which are not usually transparent. The report recommends that decision-makers should take into account such system costs and internalise them according to a "generator pays" principle, which is currently not the case. Analysing data from six OECD/NEA countries, the study finds that including the system costs of variable renewables at the level of the electricity grid increases the total costs of electricity supply by up to one-third, depending on technology, country and penetration levels. In addition, it concludes that, unless the current market subsidies for renewables are altered, dispatchable technologies will increasingly not be replaced as they reach their end of life and consequently security of supply will suffer. This implies that significant changes in management and cost allocation will be needed to generate the flexibility required for an economically viable coexistence of nuclear energy and renewables in increasingly decarbonised electricity systems.